



Lenkung
Steering

2016



TEMPLIN

Qualität fährt mit.
Quality in motion.





Lieferfähigkeit

Supply availability

Bitte erfragen Sie die Lieferfähigkeit der Produkte beim Templin Customer Service Center.
Please ask for supply availability of products the Templin Customer Service Center.

Allgemeine Informationen

General Information

Es gelten ausschließlich unsere Verkaufsbedingungen. Die angegebenen Preise sind freibleibend. Bitte beachten Sie, dass sich alle Preise zzgl. MwSt verstehen. Irrtümer, Lieferfähigkeit und Preisanpassungen bleiben vorbehalten. Jedwede Bestellung bedarf unserer schriftlichen Zusage für eine Bindungswirkung. Original-Ersatzteilnummern dienen lediglich Vergleichszwecken. Sie dürfen nicht in Lieferscheinen und Rechnungen an die Fahrzeughalter oder Wiederverkäufer erscheinen. ST-Templin Automotive GmbH It subjects exclusively our terms of sale. The shown prices are subject to change. Please note that all prices are excluding VAT. Mistakes, delivery and price adjustments are reserved. Any order needs our written commitment for binding effects. Original spare part numbers are only for comparison purposes and may not appear on any delivery notes or invoices to vehicle owners or resellers. ST-Templin Automotive GmbH



Willkommen bei ST-Templin.
Welcome to ST-Templin.



Sie haben Fragen zu einem unserer Produkte oder wünschen ein unverbindliches Angebot? Unser Customer Service Center ist für Sie da: Wir freuen uns, wenn wir Ihnen helfen können! Rufen Sie uns an!

You have questions regarding our ST-products or wish a nonbinding offer? Our Customer Service Center is there for you: We are happy, if we can help you! Give us a call!

Service-Hotline

+49 5156 9610-0

E-Mail

csc@st-templin.com

Das Unternehmen

The company

Mit Kompetenz und gutem Service.

So steht Ihnen Templin bei Nutzfahrzeug-Ersatzteilen seit 70 Jahren zur Seite.

„Qualität fährt mit“ ist dabei seit jeher der Leitgedanke und die Philosophie unseres Unternehmens. Seit 70 Jahren beliefern wir unsere Kunden mit qualitativ hochwertigen Ersatzteilen für Nutzfahrzeuge.

Auch in Zukunft hat die Zufriedenheit unserer Kunden höchste Priorität.

With competence and good service.

Thus Templin is for 70 years on your side regarding spare parts.

„Quality in motion“ is the basic idea and the philosophy of our company. For 70 years we supply our customers with high-quality spare parts for commercial vehicles.

Also in future the satisfaction of our customers has top priority.



Die Marke

The trade mark

Weltweit steht das Firmenzeichen ST für Qualität, Zuverlässigkeit und Partnerschaft im NKW-Ersatzteilegeschäft.

Seit der Firmengründung durch Siegfried Templin sen. gehört dieses Markenzeichen untrennbar zum Unternehmen. Der Firmengründer, wie auch sein Sohn, tragen das ST in ihrem Namen.

Zukünftig werden wir die Werte und die Identität unserer Marke weiter ausbauen.

The trademark ST worldwide stands for quality, reliability and partnership in the commercial vehicle spare parts business.

Since the company foundation by Siegfried Templin sen. this brand name belongs inseparably to the company. The company founder, as well as his son, carries the ST in his name.

In future we will expand the values and the identity of our trade mark.

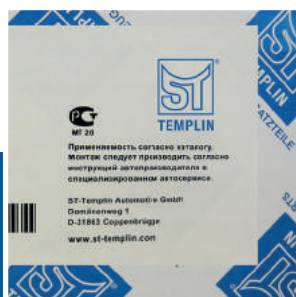

Fahrzeugindex

Vehicle applications



LKW Truck

DAF
Iveco
Kamaz
MAN
MCI
Mercedes-Benz
Renault Trucks
Scania
Volvo
...

Bus Bus

Bova
Irisbus
Iveco Bus
MAN
Mercedes-Benz
Neoplan
Scania Bus
Setra
Solaris
VDI Bus
Van Hool
Volvo
...

Achse & Anhänger

Axle & Trailer
Bergische Achsen
Fruehauf
Gigant / SAE
Hendrickson
Kässbohrer
Kögel
Krone
Mercedes-Benz
Meritor / ROR
Neway
RABA
SAF-Holland
Samro
Schmitz Cargobull
SMB
Trailor
Weweler
ZF
...

Kleintransporter

LCV
Citroën
Fiat
Ford
Hino
Isuzu
Iveco
Mercedes-Benz
Mitsubishi
Nissan
Opel
Peugeot
Renault
Volkswagen
...



Produktgruppen

Product groups

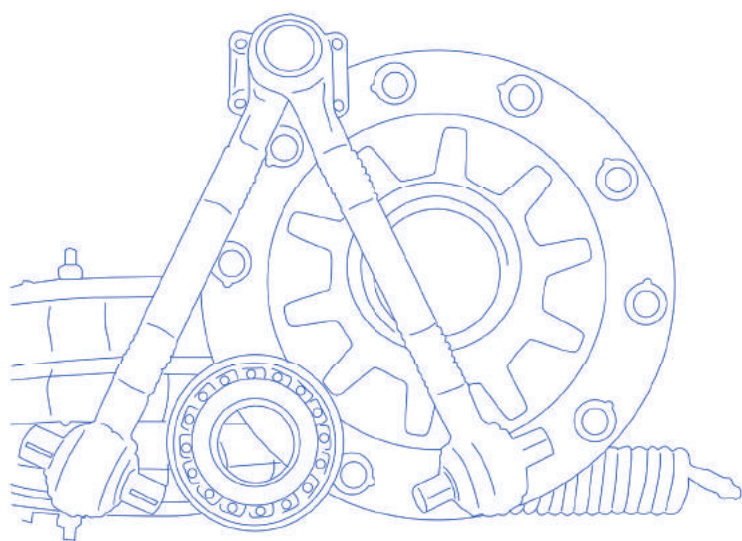

Perfekt ausgerüstet - in allen Bereichen.
Perfectly equipped - in all sectors.

Elektrik	Electric
Druckluft	Compressed air
Bremse	Brake
Federung	Suspension
Lenkung	Steering
Fahrwerk	Wheel suspension
Motorkühlung & Kraftstoff	Engine cooling & Fuel
Motor	Engine
Kupplung	Clutch
Kraftübertragung	Drive train
Fahrerhaus	Driver cab
Rad & Radnabe	Wheel & Wheel hub
Achse	Axle
DIN- & Normteile	DIN- & Norm parts

passend für to fit to		
BPW	Achsen & Anhänger Axles & Trailer	10
passend für to fit to		
Kässbohrer	Achsen & Anhänger Axles & Trailer	12
passend für to fit to		
SAF	Achsen & Anhänger Axles & Trailer	14
passend für to fit to		
DAF	Bus	16
passend für to fit to		
Irisbus	Bus	18
passend für to fit to		
Iveco	Bus	20
passend für to fit to		
MAN	Bus	23
passend für to fit to		
Mercedes-Benz	Bus	33
passend für to fit to		
Neoplan	Bus	47
passend für to fit to		
Scania	Bus	52
passend für to fit to		
Setra	Bus	58
passend für to fit to		
Solaris	Bus	64
passend für to fit to		
Van Hool	Bus	66
passend für to fit to		
VDL Bova	Bus	68
passend für to fit to		
Volvo	Bus	71
passend für to fit to		
Iveco	Kleintransporter Light commercial vehicle	81
passend für to fit to		
Mercedes-Benz	Kleintransporter Light commercial vehicle	83
passend für to fit to		
Renault Trucks	Kleintransporter Light commercial vehicle	96
passend für to fit to		
Volkswagen	Kleintransporter Light commercial vehicle	98

passend für to fit to		
DAF	LKW Truck	100
passend für to fit to		
Iveco	LKW Truck	123
passend für to fit to		
MAN	LKW Truck	137
passend für to fit to		
Mercedes-Benz	LKW Truck	163
passend für to fit to		
Renault Trucks	LKW Truck	204
passend für to fit to		
Scania	LKW Truck	217
passend für to fit to		
Volvo	LKW Truck	230

passend für
to fit to

BPW

Achsen & Anhänger
Axles & Trailer

ST-Artikel ST-Article	Vergleichs-Nr. Comparison No.	passend für to fit to	Details Details
05.030.0610.330 Kugelgelenk Ball Joint	02.180.812.00 19614 01	BPW	135 x 38 / M38 x1,5
			
 Komplementärteil complemen- tary part	05.030.1910.980, Kugelgelenk Ball Joint		

passend für
to fit to

Kässbohrer

Achsen & Anhänger
Axles & Trailer

ST-Artikel ST-Article	Vergleichs-Nr. Comparison No.	passend für to fit to	Details Details
05.030.0610.330 Kugelgelenk Ball Joint	6.851.490.000 19614 01	Kässbohrer	135 x 38 / M38 x1,5
			
 Komplementärteil complemen- tary part	05.030.1910.980, Kugelgelenk Ball Joint		

passend für
to fit to

SAF

Achsen & Anhänger
Axles & Trailer

ST-Artikel ST-Article	Vergleichs-Nr. Comparison No.	passend für to fit to	Details Details
05.030.0610.330 Kugelgelenk Ball Joint	2.205.0003.00 19614 01	RLBM, RLSM, SK RLS, SK RLZ, WRLZM	135 x 38 / M38 x1,5
			
 Komplementärteil complemen- tary part	05.030.1910.980, Kugelgelenk Ball Joint		

passend für
to fit to
DAF
Bus

ST-Artikel
ST-Article

Vergleichs-Nr.
Comparison No.

passend für
to fit to

Details
Details

05.030.1907.209

Kugelgelenk
Ball Joint



1331 925
1229 944

11402 01
25718 01
24570 01

SB - Serie

120 x 26 / M30 x 1,5



Ersatzteil bzw. Rep.Satz | spare
part or rep.-kit

Komplementärteil | complemen-
tary part

05.010.1913.500, Spurstange | Tie Rod
05.020.0280.800, Lenkstange | Drag Rod
05.020.0994.560, Lenkstange | Drag Rod
05.020.0994.570, Lenkstange | Drag Rod
05.020.1913.280, Lenkstange | Drag Rod
05.020.4007.084, Lenkstange | Drag Rod
05.020.4007.085, Lenkstange | Drag Rod

05.030.1907.549, Kugelgelenk | Ball Joint

passend für
to fit to
Irisbus
Bus

ST-Artikel ST-Article	Vergleichs-Nr. Comparison No.	passend für to fit to	Details Details
05.010.4256.150 Spurstange Tie Rod 	5 0314 0712 24008 01	Agora, Citelis	1675 x Ø50 x 26 
 Ersatzteil bzw. Rep.Satz spare part or rep.-kit	05.030.1907.209, Kugelgelenk Ball Joint		
05.020.4251.560 Lenkstange Drag Rod 	5010 393 579 5010 206 705 24613 01	Access Bus 127, Agora	955 x Ø50 x 30 
 Ersatzteil bzw. Rep.Satz spare part or rep.-kit	05.030.0907.029, Kugelgelenk Ball Joint		
05.050.0884.000 Hydraulikpumpe, Lenkung Hydraulic Pump, Steering 	4121 1223 8695.955.116	Arway, Citelis, Evadys	M26x1,5 / M18x1,5 

passend für
to fit to

Iveco
Bus

ST-Artikel ST-Article	Vergleichs-Nr. Comparison No.	passend für to fit to	Details Details
<p>05.010.0803.180</p> <p>Spurstange Tie Rod</p> 	<p>4100 5451 4100 5450</p> <p>21285 01</p>	<p>Eurorider</p>	<p>1620 x Ø48 x 30</p> 
<p><i>i</i> Ersatzteil bzw. Rep.Satz spare part or rep.-kit</p>	<p>05.030.0907.019, Kugelgelenk Ball Joint 05.030.0907.029, Kugelgelenk Ball Joint</p>		
<p>05.010.4256.150</p> <p>Spurstange Tie Rod</p> 	<p>5 0314 0712</p> <p>24008 01</p>	<p>Iveco</p>	<p>1675 x Ø50 x 26</p> 
<p><i>i</i> Ersatzteil bzw. Rep.Satz spare part or rep.-kit</p>	<p>05.030.1907.209, Kugelgelenk Ball Joint</p>		
<p>05.030.0907.019</p> <p>Kugelgelenk Ball Joint</p> 	<p>0483 3830 0480 2444</p> <p>11492 03 11492 02 11390 01</p>	<p>Iveco</p>	<p>125 x 30 / M30 x 1,5</p> 
<p><i>i</i> Ersatzteil bzw. Rep.Satz spare part or rep.-kit</p>	<p>05.010.0280.900, Spurstange Tie Rod 05.010.0803.630, Spurstange Tie Rod 05.010.0994.510, Spurstange Tie Rod 05.010.1913.460, Spurstange Tie Rod 05.010.4007.067, Spurstange Tie Rod 05.010.4007.068, Spurstange Tie Rod 05.010.4256.320, Spurstange Tie Rod 05.010.4256.330, Spurstange Tie Rod 05.010.4256.350, Spurstange Tie Rod 05.020.0280.820, Lenkstange Drag Rod 05.020.0280.830, Lenkstange Drag Rod 05.020.0994.110, Lenkstange Drag Rod 05.020.0994.120, Lenkstange Drag Rod 05.020.0994.160, Lenkstange Drag Rod 05.020.0994.260, Lenkstange Drag Rod 05.020.0994.280, Lenkstange Drag Rod</p>		
<p>Komplementärteil complementary part</p>	<p>05.030.0907.029, Kugelgelenk Ball Joint</p>		

ST-Artikel
ST-Article

Vergleichs-Nr.
Comparison No.

passend für
to fit to

Details
Details

05.030.0907.030

9319 2809

City Class

80 x 30 / M30 x 1,5

Kugelgelenk
Ball Joint

25165 01



05.050.0884.000

4121 1223

Eurorider

M26x1,5 / M18x1,5













Hydraulikpumpe, Lenkung
Hydraulic Pump, Steering









8695.955.116









passend für
to fit to
MAN
Bus



ST-Artikel ST-Article	Vergleichs-Nr. Comparison No.	passend für to fit to	Details Details
05.010.0993.220 Spurstange Tie Rod 	81.46711.6736 81.46711.6747 11770 01	Lion's Coach, Lion's Star	1588 x Ø52 x 30 
	Ersatzteil bzw. Rep.Satz spare part or rep.-kit	05.030.0907.029, Kugelgelenk Ball Joint	
05.010.0993.330 Spurstange Tie Rod 	81.46711.6921 81.46711.6860 25395 01	NÜ	1680 x Ø52 x 30 
	Ersatzteil bzw. Rep.Satz spare part or rep.-kit	05.030.3040.110, Kugelgelenk Ball Joint	
05.010.0993.500 Spurstange Tie Rod 	81.46711.6712 81.46711.6786 33998 01	EL, ND, NG, NL, NM	1689 x Ø50 x 26 
	Ersatzteil bzw. Rep.Satz spare part or rep.-kit	05.030.0280.220, Kugelgelenk Ball Joint	
05.010.0993.610 Spurstange Tie Rod 	81.46711.6715 22704 01	Lion's City, N, ND, NG, NL, NM, NÜ	1702 x Ø50 x 30 
	Ersatzteil bzw. Rep.Satz spare part or rep.-kit	05.030.0993.860, Kugelgelenk Ball Joint	

ST-Artikel ST-Article	Vergleichs-Nr. Comparison No.	passend für to fit to	Details Details
05.010.0993.700 Spurstange Tie Rod 	81.46710.6316 81.46710.6315 23275 01	HOCL	1545 x Ø38 x 26 
 Ersatzteil bzw. Rep.Satz spare part or rep.-kit	05.030.1907.209, Kugelgelenk Ball Joint 05.030.1907.549, Kugelgelenk Ball Joint		
05.010.0993.810 Spurstange Tie Rod 	81.46711.6762 81.46711.6764 20410 01	Lion's Coach, Lion's Star, R, SG, SL, SL II, SR, SÜ	501 x Ø40 x 30 
 Ersatzteil bzw. Rep.Satz spare part or rep.-kit	05.030.0907.019, Kugelgelenk Ball Joint 05.030.0907.029, Kugelgelenk Ball Joint		
05.010.0993.820 Spurstange Tie Rod 	81.46711.6722 81.46710.6902 22544 01	HOCL, ÜL	1676 x Ø50 x 30 
 Ersatzteil bzw. Rep.Satz spare part or rep.-kit	05.030.0907.029, Kugelgelenk Ball Joint		
05.010.0993.910 Spurstange Tie Rod 	81.46711.6711 81.46710.6934 23307 01	HOCL	1650 x Ø50 x 26 
 Ersatzteil bzw. Rep.Satz spare part or rep.-kit	05.030.0280.220, Kugelgelenk Ball Joint		

ST-Artikel ST-Article	Vergleichs-Nr. Comparison No.	passend für to fit to	Details Details
05.010.0994.060 Spurstange Tie Rod 	81.46711.6877 81.46711.6879 27849 01	Lion's Coach, Lion's Star, ÜL	413 x Ø36 x 30 
05.020.0993.600 Lenkstange Drag Rod 	81.46611.6016 81.46610.6684 21469 01	EL, ND, NG, NL, NM	1045/1245 x Ø60 x 30 
05.020.0993.630 Lenkstange Drag Rod 	81.46611.6045 25629 01	HOCL, Lion's City, N, ND, NG, NL, NM, NÜ	628 x Ø40 x 30 
05.020.0993.640 Lenkstange Drag Rod 	81.46611.6067 81.46610.6708 21001 01	Lion's Classic, SL II, SÜ	905 x Ø52 x 30 
 Ersatzteil bzw. Rep.Satz spare part or rep.-kit	05.030.0907.029, Kugelgelenk Ball Joint		

ST-Artikel ST-Article	Vergleichs-Nr. Comparison No.	passend für to fit to	Details Details
05.020.0993.720 Lenkstange Drag Rod 	81.46611.6063 81.46610.6313 11765 01	HOCL	895 x Ø52 x 30 
<i>i</i>	Ersatzteil bzw. Rep.Satz spare part or rep.-kit	05.030.0907.029, Kugelgelenk Ball Joint	
05.020.0993.770 Lenkstange Drag Rod 	81.46611.6019 81.46610.6374 22058 01	EL, ND, NG, NL, NM	1050 x Ø42 x 30 
<i>i</i>	Ersatzteil bzw. Rep.Satz spare part or rep.-kit	05.030.0907.019, Kugelgelenk Ball Joint 05.030.0907.029, Kugelgelenk Ball Joint	
05.020.0993.780 Lenkstange Drag Rod 	81.46611.6085 81.46611.6114 25630 01	HOCL, Lion's City, Lion's Coach, N, ND, NG, NL, NM, NÜ	1358 x Ø52 x 30 
<i>i</i>	Ersatzteil bzw. Rep.Satz spare part or rep.-kit	05.030.0907.130, Kugelgelenk Ball Joint	
05.020.0993.900 Lenkstange Drag Rod 	81.46611.6061 81.46610.6654 20913 01	EM, HOCL, NM	1375 x Ø40 x 30 
<i>i</i>	Ersatzteil bzw. Rep.Satz spare part or rep.-kit	05.030.0907.029, Kugelgelenk Ball Joint	

ST-Artikel ST-Article	Vergleichs-Nr. Comparison No.	passend für to fit to	Details Details
05.020.0994.120 Lenkstange Drag Rod 	81.46610.6159 81.46610.6200 23428 01	HOCL	710 x Ø40 x 30 
 Ersatzteil bzw. Rep.Satz spare part or rep.-kit	05.030.0907.019, Kugelgelenk Ball Joint 05.030.0907.029, Kugelgelenk Ball Joint		
05.020.0994.160 Lenkstange Drag Rod 	81.46610.6720 81.46711.6721 24126 01	ÜL	1406 x Ø50 x 30 
 Ersatzteil bzw. Rep.Satz spare part or rep.-kit	05.030.0907.019, Kugelgelenk Ball Joint 05.030.0907.029, Kugelgelenk Ball Joint 05.030.0907.130, Kugelgelenk Ball Joint		
05.030.0280.220 Kugelgelenk Ball Joint 	81.95301.6270 23763 01	EL, NG, NL	150 x 26 / M30 x 1,5 
 Ersatzteil bzw. Rep.Satz spare part or rep.-kit	05.010.0994.530, Spurstange Tie Rod		

ST-Artikel ST-Article	Vergleichs-Nr. Comparison No.	passend für to fit to	Details Details
05.030.0907.019 Kugelgelenk Ball Joint	81.95301.6351 81.95301.6275	HOCL, Lion's Coach, Lion's Re- gio, Lion's Star, ÜL	125 x 30 / M30 x 1,5
	11492 03 11492 02 11390 01		
 Ersatzteil bzw. Rep.Satz spare part or rep.-kit	05.010.0280.900, Spurstange Tie Rod 05.010.0803.630, Spurstange Tie Rod 05.010.0994.510, Spurstange Tie Rod 05.010.1913.460, Spurstange Tie Rod 05.010.4007.067, Spurstange Tie Rod 05.010.4007.068, Spurstange Tie Rod 05.010.4256.320, Spurstange Tie Rod 05.010.4256.330, Spurstange Tie Rod 05.010.4256.350, Spurstange Tie Rod 05.020.0280.820, Lenkstange Drag Rod 05.020.0280.830, Lenkstange Drag Rod 05.020.0994.110, Lenkstange Drag Rod 05.020.0994.120, Lenkstange Drag Rod 05.020.0994.160, Lenkstange Drag Rod 05.020.0994.260, Lenkstange Drag Rod 05.020.0994.280, Lenkstange Drag Rod		
Komplementärteil complemen- tary part	05.030.0907.029, Kugelgelenk Ball Joint		

05.030.0907.029

Kugelgelenk
Ball Joint



81.95301.6350
81.95301.6308

11505 03
11505 02
11389 01

Lion's City, Lion's Classic,
Lion's Coach, Lion's Regio,
Lion's Star, NG, NL, SG, SL, SÜ,
ÜL

125 x 30 / M30 x 1,5



i Ersatzteil bzw. Rep.Satz | spare part or rep.-kit

05.010.0280.900, Spurstange | Tie Rod
05.010.0803.630, Spurstange | Tie Rod
05.010.0994.510, Spurstange | Tie Rod
05.010.0994.550, Spurstange | Tie Rod
05.010.1913.460, Spurstange | Tie Rod
05.010.1913.510, Spurstange | Tie Rod
05.010.4007.067, Spurstange | Tie Rod
05.010.4007.068, Spurstange | Tie Rod
05.010.4256.320, Spurstange | Tie Rod
05.010.4256.330, Spurstange | Tie Rod
05.010.4256.350, Spurstange | Tie Rod
05.020.0280.390, Lenkstange | Drag Rod
05.020.0280.830, Lenkstange | Drag Rod
05.020.0803.760, Lenkstange | Drag Rod
05.020.0803.770, Lenkstange | Drag Rod
05.020.0803.780, Lenkstange | Drag Rod
05.020.0994.110, Lenkstange | Drag Rod
05.020.0994.120, Lenkstange | Drag Rod
05.020.0994.160, Lenkstange | Drag Rod
05.020.0994.170, Lenkstange | Drag Rod
05.020.0994.190, Lenkstange | Drag Rod
05.020.0994.260, Lenkstange | Drag Rod
05.020.0994.280, Lenkstange | Drag Rod
05.020.1913.250, Lenkstange | Drag Rod
05.020.1913.290, Lenkstange | Drag Rod
05.020.1913.330, Lenkstange | Drag Rod
05.020.1913.360, Lenkstange | Drag Rod
05.020.1913.370, Lenkstange | Drag Rod
05.020.1913.380, Lenkstange | Drag Rod
05.020.1913.410, Lenkstange | Drag Rod
05.020.4256.370, Lenkstange | Drag Rod

Komplementärteil | complementary part

05.030.0907.019, Kugelgelenk | Ball Joint

05.030.0907.130

Kugelgelenk
Ball Joint



81.95301.6286
25353 01

Lion's City, Lion's Classic,
Lion's Coach, Lion's Regio,
Lion's Star, NL, SG, SL, SÜ

140 x 30 / M30 x 1,5



i Ersatzteil bzw. Rep.Satz | spare part or rep.-kit

05.010.0280.380, Spurstange | Tie Rod
05.010.0994.520, Spurstange | Tie Rod
05.010.3001.910, Spurstange | Tie Rod
05.020.0280.820, Lenkstange | Drag Rod
05.020.0994.140, Lenkstange | Drag Rod
05.020.0994.270, Lenkstange | Drag Rod

ST-Artikel ST-Article	Vergleichs-Nr. Comparison No.	passend für to fit to	Details Details
05.030.0993.860 Kugelgelenk Ball Joint 	81.95301.6271 81.95301.6325 27853 01	HOCL, Lion's City, N, ND, NG, NL, NM, NÜ	145 x 30 / M30 x 1,5 
<i>i</i> Ersatzteil bzw. Rep.Satz spare part or rep.-kit	05.010.0280.910, Spurstange Tie Rod 05.010.3001.920, Spurstange Tie Rod		
05.030.1907.209 Kugelgelenk Ball Joint 	81.95301.6272 81.95301.6360 11402 01 25718 01 24570 01	Lion's Classic	120 x 26 / M30 x 1,5 
<i>i</i> Ersatzteil bzw. Rep.Satz spare part or rep.-kit	05.010.1913.500, Spurstange Tie Rod 05.020.0280.800, Lenkstange Drag Rod 05.020.0994.560, Lenkstange Drag Rod 05.020.0994.570, Lenkstange Drag Rod 05.020.1913.280, Lenkstange Drag Rod 05.020.4007.084, Lenkstange Drag Rod 05.020.4007.085, Lenkstange Drag Rod		
Komplementärteil complemen- tary part	05.030.1907.549, Kugelgelenk Ball Joint		
05.030.1907.549 Kugelgelenk Ball Joint 	81.95301.6361 81.95301.6273 11403 01 11728 01 19675 01	HOCL	120 x 26 / M30 x 1,5 
<i>i</i> Komplementärteil complemen- tary part	05.030.1907.209, Kugelgelenk Ball Joint		

ST-Artikel
ST-Article

Vergleichs-Nr.
Comparison No.

passend für
to fit to

Details
Details

05.050.0916.110

Hydraulikpumpe, Lenkung
Hydraulic Pump, Steering



81.47101.6082
81.47101.6086

7685.955.325

EM, HOCL, NM, SÜ

M26x1,5 / M18x1,5



passend für
to fit to

Mercedes-Benz

Bus

ST-Artikel ST-Article	Vergleichs-Nr. Comparison No.	passend für to fit to	Details Details
05.010.0275.700 Spurstange Tie Rod 	21807 01	O 405, O 407, O 408	1742 x Ø40 x 26 
<i>i</i> Ersatzteil bzw. Rep.Satz spare part or rep.-kit	05.030.1907.209, Kugelgelenk Ball Joint 05.030.1907.549, Kugelgelenk Ball Joint		
05.010.1910.230 Spurstange Tie Rod 	385 330 14 03 385 330 15 03 12865 01	OF Serie	1611 x Ø46 x 26 
<i>i</i> Ersatzteil bzw. Rep.Satz spare part or rep.-kit	05.030.1907.209, Kugelgelenk Ball Joint 05.030.1907.549, Kugelgelenk Ball Joint		
05.010.1910.380 Spurstange Tie Rod 	676 330 08 03 676 330 10 03 18446 01	O 301, O 402	1540 x Ø40 x 26 
<i>i</i> Ersatzteil bzw. Rep.Satz spare part or rep.-kit	05.030.1907.209, Kugelgelenk Ball Joint 05.030.1907.549, Kugelgelenk Ball Joint		
05.010.1912.580 Spurstange Tie Rod 	356 330 01 03 613 330 01 03 18427 01	O 403, O 404, Turismo (O 350)	506 x Ø30 x 30 

ST-Artikel ST-Article	Vergleichs-Nr. Comparison No.	passend für to fit to	Details Details
05.010.1912.600 Spurstange Tie Rod 	356 330 00 03 613 330 00 03 13550 01	O 403, O 404, Tourismo (O 350)	697 x Ø32 x 30 
 Ersatzteil bzw. Rep.Satz spare part or rep.-kit	05.030.1910.960, Kugelgelenk Ball Joints 05.030.1910.970, Kugelgelenk Ball Joints		
05.010.1912.820 Spurstange Tie Rod 	628 330 05 03 33303 01	Capacity (O 530 GL), Citaro (O 530)	768 x Ø38 x 26 
 Ersatzteil bzw. Rep.Satz spare part or rep.-kit	05.030.1907.209, Kugelgelenk Ball Joint 05.030.1907.549, Kugelgelenk Ball Joint		
05.010.1912.830 Spurstange Tie Rod 	628 330 04 03 33304 01	Capacity (O 530 GL), Citaro (O 530)	768 x Ø38 x 26 
 Ersatzteil bzw. Rep.Satz spare part or rep.-kit	05.030.1907.209, Kugelgelenk Ball Joint 05.030.1907.549, Kugelgelenk Ball Joint		
05.010.1912.840 Spurstange Tie Rod 	628 460 20 05 33305 01	Capacity (O 530 GL), Citaro (O 530)	566 x Ø36 x 30 

ST-Artikel ST-Article	Vergleichs-Nr. Comparison No.	passend für to fit to	Details Details
05.010.1912.930 Spurstange Tie Rod 	628 330 01 03 382 330 04 03 37679 01 26784 01	Citaro (O 530), Conecto (O 345)	1730 x Ø62 x 26 
05.020.0993.600 Lenkstange Drag Rod 	357 460 23 05 357 460 20 05 21469 01	O 405	1045/1245 x Ø60 x 30 
05.020.1907.760 Lenkstange Drag Rod 	300 460 06 05 300 460 07 05 30906 01	O 303, O 305, O 307	975 x Ø36 x 26 
 Ersatzteil bzw. Rep.Satz spare part or rep.-kit	05.030.1907.209, Kugelgelenk Ball Joint		
05.020.1911.540 Lenkstange Drag Rod 	357 460 14 05 357 460 15 05 13554 01	O 405	1066 x Ø40 x 26 
 Ersatzteil bzw. Rep.Satz spare part or rep.-kit	05.030.1907.209, Kugelgelenk Ball Joint		

ST-Artikel ST-Article	Vergleichs-Nr. Comparison No.	passend für to fit to	Details Details
05.020.1911.570 Lenkstange Drag Rod 	357 460 10 05 357 460 11 05 12898 01	O 405, O 407, O 408, OH Serie	990 x Ø36 x 26 
 Ersatzteil bzw. Rep.Satz spare part or rep.-kit	05.030.1907.209, Kugelgelenk Ball Joint		
05.020.1911.790 Lenkstange Drag Rod 	626 460 00 05 23391 01	Mercedes-Benz	2163 x Ø48 x 30 
 Ersatzteil bzw. Rep.Satz spare part or rep.-kit	05.030.0907.019, Kugelgelenk Ball Joint 05.030.0907.029, Kugelgelenk Ball Joint		
05.020.1911.870 Lenkstange Drag Rod 	356 460 02 05 357 460 22 05 24292 01	O 404, O 405	1013 x Ø38 x 30 
 Ersatzteil bzw. Rep.Satz spare part or rep.-kit	05.030.0907.019, Kugelgelenk Ball Joint 05.030.0907.029, Kugelgelenk Ball Joint		
05.020.1911.880 Lenkstange Drag Rod 	628 460 12 05 628 460 03 05 22077 01	Citaro (O 530), Conecto (O 345)	932 x Ø42 x 30 

ST-Artikel ST-Article	Vergleichs-Nr. Comparison No.	passend für to fit to	Details Details
05.020.1911.900 Lenkstange Drag Rod 	628 460 11 05 628 460 02 05 37680 01	Citaro (O 530), Conecto (O 345)	1280 x Ø60 x 30 
 Ersatzteil bzw. Rep.Satz spare part or rep.-kit	05.030.0907.029, Kugelgelenk Ball Joint		
05.020.1912.490 Lenkstange Drag Rod 	357 460 32 05 357 460 25 05 24302 01	Conecto (O 345), O 405	920 x Ø36 x 30 
05.020.1912.500 Lenkstange Drag Rod 	357 460 24 05 357 460 31 05 24301 01	Conecto (O 345), O 405	1160 x Ø38 x 30 
05.020.1912.850 Lenkstange Drag Rod 	628 460 19 05 33306 01	Capacity (O 530 GL), Citaro (O 530)	651 x Ø38 x 30 
 Ersatzteil bzw. Rep.Satz spare part or rep.-kit	05.030.0907.019, Kugelgelenk Ball Joint 05.030.0907.029, Kugelgelenk Ball Joint		

ST-Artikel ST-Article	Vergleichs-Nr. Comparison No.	passend für to fit to	Details Details
--------------------------	----------------------------------	--------------------------	--------------------

05.030.0907.019

Kugelgelenk
Ball Joint



001 460 36 48
002 460 03 48

11492 03
11492 02
11390 01

Citaro (O 530), Conecto (O 345),
Integro (O 550), Intouro, O 404,
O 405, Travego (O 580)

125 x 30 / M30 x 1,5



Ersatzteil bzw. Rep.Satz | spare
part or rep.-kit

05.010.0280.900, Spurstange | Tie Rod
05.010.0803.630, Spurstange | Tie Rod
05.010.0994.510, Spurstange | Tie Rod
05.010.1913.460, Spurstange | Tie Rod
05.010.4007.067, Spurstange | Tie Rod
05.010.4007.068, Spurstange | Tie Rod
05.010.4256.320, Spurstange | Tie Rod
05.010.4256.330, Spurstange | Tie Rod
05.010.4256.350, Spurstange | Tie Rod
05.020.0280.820, Lenkstange | Drag Rod
05.020.0280.830, Lenkstange | Drag Rod
05.020.0994.110, Lenkstange | Drag Rod
05.020.0994.120, Lenkstange | Drag Rod
05.020.0994.160, Lenkstange | Drag Rod
05.020.0994.260, Lenkstange | Drag Rod
05.020.0994.280, Lenkstange | Drag Rod

Komplementärteil | complemen-
tary part

05.030.0907.029, Kugelgelenk | Ball Joint

05.030.0907.029

Kugelgelenk
Ball Joint



001 460 77 48
001 460 22 48

Integro (O 550), Intouro, O 405,
OF Serie, Travego (O 580)

125 x 30 / M30 x 1,5

11505 03
11505 02
11389 01



Ersatzteil bzw. Rep.Satz | spare
part or rep.-kit

05.010.0280.900, Spurstange | Tie Rod
05.010.0803.630, Spurstange | Tie Rod
05.010.0994.510, Spurstange | Tie Rod
05.010.0994.550, Spurstange | Tie Rod
05.010.1913.460, Spurstange | Tie Rod
05.010.1913.510, Spurstange | Tie Rod
05.010.4007.067, Spurstange | Tie Rod
05.010.4007.068, Spurstange | Tie Rod
05.010.4256.320, Spurstange | Tie Rod
05.010.4256.330, Spurstange | Tie Rod
05.010.4256.350, Spurstange | Tie Rod
05.020.0280.390, Lenkstange | Drag Rod
05.020.0280.830, Lenkstange | Drag Rod
05.020.0803.760, Lenkstange | Drag Rod
05.020.0803.770, Lenkstange | Drag Rod
05.020.0803.780, Lenkstange | Drag Rod
05.020.0994.110, Lenkstange | Drag Rod
05.020.0994.120, Lenkstange | Drag Rod
05.020.0994.160, Lenkstange | Drag Rod
05.020.0994.170, Lenkstange | Drag Rod
05.020.0994.190, Lenkstange | Drag Rod
05.020.0994.260, Lenkstange | Drag Rod
05.020.0994.280, Lenkstange | Drag Rod
05.020.1913.250, Lenkstange | Drag Rod
05.020.1913.290, Lenkstange | Drag Rod
05.020.1913.330, Lenkstange | Drag Rod
05.020.1913.360, Lenkstange | Drag Rod
05.020.1913.370, Lenkstange | Drag Rod
05.020.1913.380, Lenkstange | Drag Rod
05.020.1913.410, Lenkstange | Drag Rod
05.020.4256.370, Lenkstange | Drag Rod

Komplementärteil | complemen-
tary part

05.030.0907.019, Kugelgelenk | Ball Joint

05.030.0907.130

Kugelgelenk
Ball Joint



629 338 00 10
25353 01

Mercedes-Benz

140 x 30 / M30 x 1,5



Ersatzteil bzw. Rep.Satz | spare
part or rep.-kit

05.010.0280.380, Spurstange | Tie Rod
05.010.0994.520, Spurstange | Tie Rod
05.010.3001.910, Spurstange | Tie Rod
05.020.0280.820, Lenkstange | Drag Rod
05.020.0994.140, Lenkstange | Drag Rod
05.020.0994.270, Lenkstange | Drag Rod

ST-Artikel ST-Article	Vergleichs-Nr. Comparison No.	passend für to fit to	Details Details
05.030.1907.130 Kugelgelenk Ball Joint	001 330 07 35 001 330 09 35 30902 01 11405 01	O 309	160 x 18 / M24 x 1,5 
	Komplementärteil complemen- tary part 05.030.1907.140, Kugelgelenk Ball Joint		
05.030.1907.140 Kugelgelenk Ball Joint	001 330 08 35 001 330 10 35 30903 01 11406 01	O 309	160 x 18 / M24 x 1,5 
	Komplementärteil complemen- tary part 05.030.1907.130, Kugelgelenk Ball Joint		
05.030.1907.160 Kugelgelenk Ball Joint	000 330 94 35 000 330 96 35 11379 01	O 814, O 817	101 x 22 / M28 xx 1,5 
	Komplementärteil complemen- tary part 05.030.1907.120, Kugelgelenk Ball Joint		

ST-Artikel
ST-Article

Vergleichs-Nr.
Comparison No.

passend für
to fit to

Details
Details

05.030.1907.209

Kugelgelenk
Ball Joint



Ersatzteil bzw. Rep.Satz | spare part or rep.-kit

Komplementärteil | complementary part

001 330 01 35
001 330 02 35

11402 01
25718 01
24570 01

05.010.1913.500, Spurstange | Tie Rod
05.020.0280.800, Lenkstange | Drag Rod
05.020.0994.560, Lenkstange | Drag Rod
05.020.0994.570, Lenkstange | Drag Rod
05.020.1913.280, Lenkstange | Drag Rod
05.020.4007.084, Lenkstange | Drag Rod
05.020.4007.085, Lenkstange | Drag Rod

05.030.1907.549, Kugelgelenk | Ball Joint

O 302, O 304, O 330, O 340,
O 405, O 407, O 408, OF Serie

120 x 26 / M30 x 1,5



05.030.1907.210

Kugelgelenk
Ball Joint



Komplementärteil | complementary part

001 330 21 35
001 330 26 35

30904 01

05.030.1907.220, Kugelgelenk | Ball Joint

O 303, O 305, O 307, O 340,
O 405, O 408

150 x 26 / M35 x 1,5



05.030.1907.220

Kugelgelenk
Ball Joint



Komplementärteil | complementary part

001 330 22 35
001 330 27 35

30905 01

05.030.1907.210, Kugelgelenk | Ball Joint

O 303, O 305, O 307, O 340,
O 405, O 408

150 x 26 / M35 x 1,5

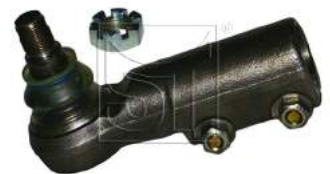

ST-Artikel ST-Article	Vergleichs-Nr. Comparison No.	passend für to fit to	Details Details
05.030.1907.230 Kugelgelenk Ball Joint 	000 460 85 48 000 460 45 48 11391 01	O 309	95 x 18 / M22 x 1,5 
05.030.1907.549 Kugelgelenk Ball Joint 	302 330 02 35 302 330 03 35 11403 01 11728 01 19675 01	OF Serie, OH Serie	120 x 26 / M30 x 1,5 
<i>i</i> Komplementärteil complementary part	05.030.1907.209, Kugelgelenk Ball Joint		
05.030.1910.700 Kugelgelenk Ball Joint 	001 460 76 48 001 460 17 48 11394 04 11394 03	OH Serie	125 x 32 / M30 x 1,5 
<i>i</i> Ersatzteil bzw. Rep.Satz spare part or rep.-kit	05.010.1913.430, Spurstange Tie Rod 05.020.1913.210, Lenkstange Drag Rod 05.020.1913.240, Lenkstange Drag Rod 05.020.1913.260, Lenkstange Drag Rod 05.020.1913.300, Lenkstange Drag Rod 05.020.1913.350, Lenkstange Drag Rod 05.020.1913.390, Lenkstange Drag Rod		
Komplementärteil complementary part	05.030.1910.440, Kugelgelenk Ball Joint		

ST-Artikel ST-Article	Vergleichs-Nr. Comparison No.	passend für to fit to	Details Details
05.030.1910.920 Kugelgelenk Ball Joint 	310 330 20 35 310 330 24 35 12836 01	O 309	160 x 20 / M24 x 1,5 
 Komplementärteil complemen- tary part	05.030.1910.930, Kugelgelenk Ball Joint		
05.030.1910.930 Kugelgelenk Ball Joint 	310 330 21 35 310 330 25 35 12837 01	O 309	160 x 10 / M24 x 1,5 
 Komplementärteil complemen- tary part	05.030.1910.920, Kugelgelenk Ball Joint		
05.030.1910.940 Kugelgelenk Ball Joint 	310 330 22 35 310 330 26 35 19702 01	O 309	190 x 20 / M24 x 1,5 
 Komplementärteil complemen- tary part	05.030.1910.950, Kugelgelenk Ball Joint		
05.030.1910.950 Kugelgelenk Ball Joint 	310 330 23 35 310 330 27 35 19703 01	O 309	190 x 20 / M24 x 1,5 
 Komplementärteil complemen- tary part	05.030.1910.940, Kugelgelenk Ball Joint		

ST-Artikel ST-Article	Vergleichs-Nr. Comparison No.	passend für to fit to	Details Details
05.030.1910.960 Kugelgelenk Ball Joints 	000 460 77 48 001 460 21 48 21296 01 21066 01	O 404, Tourismo (O 350)	125 x 30 / M24 x 1,5 
 Komplementärteil complemen- tary part	05.030.1910.970, Kugelgelenk Ball Joints		
05.030.1910.970 Kugelgelenk Ball Joints 	000 460 78 48 001 460 20 48 21297 01	O 404, Tourismo (O 350)	125 x 30 / M24 x 1,5 
 Komplementärteil complemen- tary part	05.030.1910.960, Kugelgelenk Ball Joints		
05.050.1915.030 Hydraulikpumpe, Lenkung Hydraulic Pump, Steering 	001 460 30 80 001 460 51 80 8695.955.147	Travego (O 580)	M26x1,5 / M16x1,5 
05.050.1915.040 Hydraulikpumpe, Lenkung Hydraulic Pump, Steering 	001 460 44 80 001 460 75 80 7685.955.246	Citaro (O 530), Tourino (O 510)	M26x1,5 / M16x1,5 

ST-Artikel
ST-Article

Vergleichs-Nr.
Comparison No.

passend für
to fit to

Details
Details

05.050.1915.060

Hydraulikpumpe, Lenkung
Hydraulic Pump, Steering



001 460 31 80
003 460 51 80
542 0048 10

Tourismo (O 350), Trave-
go (O 580)

M26x1,5 / M16x1,5



05.050.1915.080

Hydraulikpumpe, Lenkung
Hydraulic Pump, Steering



002 460 76 80
000 460 24 80
7684.955.198

O 303, O 305, O 307

M26x1,5 / M16x1,5



05.050.1915.090

Hydraulikpumpe, Lenkung
Hydraulic Pump, Steering













000 460 94 80
001 460 42 80
7684.955.182









Citaro (O 530)

M26x1,5 / M18x1,5



passend für
to fit to
Neoplan
Bus

ST-Artikel ST-Article	Vergleichs-Nr. Comparison No.	passend für to fit to	Details Details
05.010.0993.220 Spurstange Tie Rod 	81.46711.6736 11770 01	Tourliner, Trendliner	1588 x Ø52 x 30 
 Ersatzteil bzw. Rep.Satz spare part or rep.-kit	05.030.0907.029, Kugelgelenk Ball Joint		
05.010.0993.610 Spurstange Tie Rod 	81.46711.6715 22704 01	Centroliner	1702 x Ø50 x 30 
 Ersatzteil bzw. Rep.Satz spare part or rep.-kit	05.030.0993.860, Kugelgelenk Ball Joint		
05.010.0994.060 Spurstange Tie Rod 	81.46711.6877 27849 01	Centroliner, Tourliner	413 x Ø36 x 30 
05.020.0993.630 Lenkstange Drag Rod 	81.46611.6045 25629 01	Centroliner	628 x Ø40 x 30 

ST-Artikel ST-Article	Vergleichs-Nr. Comparison No.	passend für to fit to	Details Details
05.020.0993.780 Lenkstange Drag Rod 	81.46611.6085 25630 01	Centroliner	1358 x Ø52 x 30 
 Ersatzteil bzw. Rep.Satz spare part or rep.-kit	05.030.0907.130, Kugelgelenk Ball Joint		
05.030.0280.190 Kugelgelenk Ball Joint 	1101 9669 19821 01	Neoplan	115 x 26 / M28 x 1,5 
 Komplementärteil complementary part	05.030.0280.180, Kugelgelenk Ball Joint		
05.030.0907.019 Kugelgelenk Ball Joint 	122353201 120325200 11492 03 11492 02 11390 01	Cityliner, Jetliner, Starliner, Tourliner, Trendliner	125 x 30 / M30 x 1,5 
 Ersatzteil bzw. Rep.Satz spare part or rep.-kit	05.010.0280.900, Spurstange Tie Rod 05.010.0803.630, Spurstange Tie Rod 05.010.0994.510, Spurstange Tie Rod 05.010.1913.460, Spurstange Tie Rod 05.010.4007.067, Spurstange Tie Rod 05.010.4007.068, Spurstange Tie Rod 05.010.4256.320, Spurstange Tie Rod 05.010.4256.330, Spurstange Tie Rod 05.010.4256.350, Spurstange Tie Rod 05.020.0280.820, Lenkstange Drag Rod 05.020.0280.830, Lenkstange Drag Rod 05.020.0994.110, Lenkstange Drag Rod 05.020.0994.120, Lenkstange Drag Rod 05.020.0994.160, Lenkstange Drag Rod 05.020.0994.260, Lenkstange Drag Rod 05.020.0994.280, Lenkstange Drag Rod		
Komplementärteil complementary part	05.030.0907.029, Kugelgelenk Ball Joint		

05.030.0907.029

Kugelgelenk
Ball Joint



81.95301.6350

11505 03

11505 02

11389 01

Centroliner, Cityliner, Jetliner,
Neoplan, Starliner, Tourliner,
Trendliner

125 x 30 / M30 x 1,5



Ersatzteil bzw. Rep.Satz | spare
part or rep.-kit

05.010.0280.900, Spurstange | Tie Rod
05.010.0803.630, Spurstange | Tie Rod
05.010.0994.510, Spurstange | Tie Rod
05.010.0994.550, Spurstange | Tie Rod
05.010.1913.460, Spurstange | Tie Rod
05.010.1913.510, Spurstange | Tie Rod
05.010.4007.067, Spurstange | Tie Rod
05.010.4007.068, Spurstange | Tie Rod
05.010.4256.320, Spurstange | Tie Rod
05.010.4256.330, Spurstange | Tie Rod
05.010.4256.350, Spurstange | Tie Rod
05.020.0280.390, Lenkstange | Drag Rod
05.020.0280.830, Lenkstange | Drag Rod
05.020.0803.760, Lenkstange | Drag Rod
05.020.0803.770, Lenkstange | Drag Rod
05.020.0803.780, Lenkstange | Drag Rod
05.020.0994.110, Lenkstange | Drag Rod
05.020.0994.120, Lenkstange | Drag Rod
05.020.0994.160, Lenkstange | Drag Rod
05.020.0994.170, Lenkstange | Drag Rod
05.020.0994.190, Lenkstange | Drag Rod
05.020.0994.260, Lenkstange | Drag Rod
05.020.0994.280, Lenkstange | Drag Rod
05.020.1913.250, Lenkstange | Drag Rod
05.020.1913.290, Lenkstange | Drag Rod
05.020.1913.330, Lenkstange | Drag Rod
05.020.1913.360, Lenkstange | Drag Rod
05.020.1913.370, Lenkstange | Drag Rod
05.020.1913.380, Lenkstange | Drag Rod
05.020.1913.410, Lenkstange | Drag Rod
05.020.4256.370, Lenkstange | Drag Rod

Komplementärteil | complemen-
tary part

05.030.0907.019, Kugelgelenk | Ball Joint

05.030.0907.130

Kugelgelenk
Ball Joint



Ersatzteil bzw. Rep.Satz | spare
part or rep.-kit

81.95301.6286

25353 01

Centroliner, Neoplan, Skyliner,
Starliner, Tourliner, Trendliner

140 x 30 / M30 x 1,5





05.010.0280.380, Spurstange | Tie Rod
05.010.0994.520, Spurstange | Tie Rod
05.010.3001.910, Spurstange | Tie Rod
05.020.0280.820, Lenkstange | Drag Rod
05.020.0994.140, Lenkstange | Drag Rod
05.020.0994.270, Lenkstange | Drag Rod

ST-Artikel ST-Article	Vergleichs-Nr. Comparison No.	passend für to fit to	Details Details
05.030.0993.860 Kugelgelenk Ball Joint 	27853 01	Centroliner	145 x 30 / M30 x 1,5 
<i>i</i> Ersatzteil bzw. Rep.Satz spare part or rep.-kit	05.010.0280.910, Spurstange Tie Rod 05.010.3001.920, Spurstange Tie Rod		
05.030.0993.870 Kugelgelenk Ball Joint 	81.95301.6291 21075 01	Tourliner, Trendliner	80 x 30 / M26 x 1,5 
05.030.1907.549 Kugelgelenk Ball Joint 	11015685 82192200 11403 01 11728 01 19675 01	Neoplan	120 x 26 / M30 x 1,5 
<i>i</i> Komplementärteil complementary part	05.030.1907.209, Kugelgelenk Ball Joint		
05.030.1980.860 Kugelgelenk Ball Joint 	1203 240 01 1203 240 02 11380 01 19674 01 11380 02	Neoplan	106 x 22 / M24 x 1,5 
<i>i</i> Komplementärteil complementary part	05.030.1907.410, Kugelgelenk Ball Joint		

passend für
to fit to
Scania
Bus

ST-Artikel ST-Article	Vergleichs-Nr. Comparison No.	passend für to fit to	Details Details
05.010.3001.620 Spurstange Tie Rod 	1 897 333 1 734 019 37547 01 23495 01 23495 02	F-/K-/N- Serie bus, Irizar PB, 4 - Serie bus	1743 x Ø62 x 30 
<i>i</i> Ersatzteil bzw. Rep.Satz spare part or rep.-kit	05.030.3040.110, Kugelgelenk Ball Joint		
05.010.3040.160 Spurstange Tie Rod 	2 028 998 1 734 020 19866 01 19866 02 27574 02	F-/K-/N- Serie bus, 4 - Serie bus	1736 x Ø40 x 30 
<i>i</i> Ersatzteil bzw. Rep.Satz spare part or rep.-kit	05.030.0907.019, Kugelgelenk Ball Joint 05.030.0907.029, Kugelgelenk Ball Joint		
05.020.3001.720 Lenkstange Drag Rod 	1 897 669 481 217 21450 01	4 - Serie bus	1256 x Ø62 x 30 
<i>i</i> Ersatzteil bzw. Rep.Satz spare part or rep.-kit	05.030.0907.029, Kugelgelenk Ball Joint		
05.020.3040.210 Lenkstange Drag Rod 	1 897 671 481 690 21449 01	4 - Serie bus	1256 x Ø62 x 30 
<i>i</i> Ersatzteil bzw. Rep.Satz spare part or rep.-kit	05.030.0907.029, Kugelgelenk Ball Joint		

ST-Artikel ST-Article	Vergleichs-Nr. Comparison No.	passend für to fit to	Details Details
05.020.3040.220 Lenkstange Drag Rod 	1 895 858 1 755 498 28970 01	F-/K-/N- Serie bus, 4 - Serie bus	1272 x Ø62 x 30 
 Ersatzteil bzw. Rep.Satz spare part or rep.-kit	05.030.0907.130, Kugelgelenk Ball Joint		
05.020.3040.350 Lenkstange Drag Rod 	1 895 860 1 755 502 29388 01	F-/K-/N- Serie bus, Irizar PB, 4 - Serie bus	882 x Ø48 x 30 
 Ersatzteil bzw. Rep.Satz spare part or rep.-kit	05.030.0907.130, Kugelgelenk Ball Joint		
05.030.0907.019 Kugelgelenk Ball Joint 	1 738 380 1 358 792 11492 03 11492 02 11390 01	K / N - Buses, K - Serie, 3 - Serie bus, 4 - Serie bus	125 x 30 / M30 x 1,5 
 Ersatzteil bzw. Rep.Satz spare part or rep.-kit	05.010.0280.900, Spurstange Tie Rod 05.010.0803.630, Spurstange Tie Rod 05.010.0994.510, Spurstange Tie Rod 05.010.1913.460, Spurstange Tie Rod 05.010.4007.067, Spurstange Tie Rod 05.010.4007.068, Spurstange Tie Rod 05.010.4256.320, Spurstange Tie Rod 05.010.4256.330, Spurstange Tie Rod 05.010.4256.350, Spurstange Tie Rod 05.020.0280.820, Lenkstange Drag Rod 05.020.0280.830, Lenkstange Drag Rod 05.020.0994.110, Lenkstange Drag Rod 05.020.0994.120, Lenkstange Drag Rod 05.020.0994.160, Lenkstange Drag Rod 05.020.0994.260, Lenkstange Drag Rod 05.020.0994.280, Lenkstange Drag Rod		
Komplementärteil complementary part	05.030.0907.029, Kugelgelenk Ball Joint		









ST-Artikel ST-Article	Vergleichs-Nr. Comparison No.	passend für to fit to	Details Details
05.030.0907.029 Kugelgelenk Ball Joint	1 358 793 1 914 427 11505 03 11505 02 11389 01	K / N - Buses, K - Serie, 4 - Serie bus	125 x 30 / M30 x 1,5
			
 Ersatzteil bzw. Rep.Satz spare part or rep.-kit	05.010.0280.900, Spurstange Tie Rod 05.010.0803.630, Spurstange Tie Rod 05.010.0994.510, Spurstange Tie Rod 05.010.0994.550, Spurstange Tie Rod 05.010.1913.460, Spurstange Tie Rod 05.010.1913.510, Spurstange Tie Rod 05.010.4007.067, Spurstange Tie Rod 05.010.4007.068, Spurstange Tie Rod 05.010.4256.320, Spurstange Tie Rod 05.010.4256.330, Spurstange Tie Rod 05.010.4256.350, Spurstange Tie Rod 05.020.0280.390, Lenkstange Drag Rod 05.020.0280.830, Lenkstange Drag Rod 05.020.0803.760, Lenkstange Drag Rod 05.020.0803.770, Lenkstange Drag Rod 05.020.0803.780, Lenkstange Drag Rod 05.020.0994.110, Lenkstange Drag Rod 05.020.0994.120, Lenkstange Drag Rod 05.020.0994.160, Lenkstange Drag Rod 05.020.0994.170, Lenkstange Drag Rod 05.020.0994.190, Lenkstange Drag Rod 05.020.0994.260, Lenkstange Drag Rod 05.020.0994.280, Lenkstange Drag Rod 05.020.1913.250, Lenkstange Drag Rod 05.020.1913.290, Lenkstange Drag Rod 05.020.1913.330, Lenkstange Drag Rod 05.020.1913.360, Lenkstange Drag Rod 05.020.1913.370, Lenkstange Drag Rod 05.020.1913.380, Lenkstange Drag Rod 05.020.1913.410, Lenkstange Drag Rod 05.020.4256.370, Lenkstange Drag Rod		
Komplementärteil complementary part	05.030.0907.019, Kugelgelenk Ball Joint		

05.030.3001.210Kugelgelenk
Ball Joint310 980
539 413

3 - Serie bus, 4 - Serie bus

168 x 30 / M52 x 1,5



ST-Artikel ST-Article	Vergleichs-Nr. Comparison No.	passend für to fit to	Details Details
05.030.3001.220 Kugelgelenk Ball Joint	310 979	3 - Serie bus, 4 - Serie bus	168 x 30 / M52 x 1,5
			
05.050.3005.100 Hydraulikpumpe, Lenkung Hydraulic Pump, Steering	1 333 790 1 422 417 542 0490 10 542 0013 10	F-/K-/N- Serie bus, 4 - Serie bus	M26x1,5 / M16x1,5
			
05.050.3005.120 Hydraulikpumpe, Lenkung Hydraulic Pump, Steering	1 332 653 1 457 711 542 0012 10	F-/K-/N- Serie bus, 4 - Serie bus	
			
05.050.3005.130 Hydraulikpumpe, Lenkung Hydraulic Pump, Steering	1 324 223 1 421 273 542 0010 10	3 - Serie bus	
			

ST-Artikel
ST-Article

Vergleichs-Nr.
Comparison No.

passend für
to fit to

Details
Details

05.050.3005.140











Hydraulikpumpe, Lenkung
Hydraulic Pump, Steering











1 504 006
1 371 404







4 - Serie bus



passend für
to fit to
Setra
Bus

ST-Artikel ST-Article	Vergleichs-Nr. Comparison No.	passend für to fit to	Details Details
05.010.0994.590 Spurstange Tie Rod 	627 330 02 03 8.226.326.000 19616 01	Serie 300	
 Ersatzteil bzw. Rep.Satz spare part or rep.-kit	05.030.0280.220, Kugelgelenk Ball Joint		
05.010.1911.800 Spurstange Tie Rod 	8.226.330.000 C 8.226.331.000.0 18494 01	Serie 200, Serie 300	380 x Ø40 x 30 
05.010.1911.810 Spurstange Tie Rod 	8.226.313.000 C 8.226.137.000 18493 01	Serie 200	380 x Ø40 x 26 
05.010.1912.820 Spurstange Tie Rod 	628 330 05 03 33303 01	Serie 400	768 x Ø38 x 26 
 Ersatzteil bzw. Rep.Satz spare part or rep.-kit	05.030.1907.209, Kugelgelenk Ball Joint 05.030.1907.549, Kugelgelenk Ball Joint		

ST-Artikel ST-Article	Vergleichs-Nr. Comparison No.	passend für to fit to	Details Details
05.010.1912.830 Spurstange Tie Rod 	628 330 04 03 33304 01	Serie 400	768 x Ø38 x 26 
 Ersatzteil bzw. Rep.Satz spare part or rep.-kit	05.030.1907.209, Kugelgelenk Ball Joint 05.030.1907.549, Kugelgelenk Ball Joint		
05.010.1912.840 Spurstange Tie Rod 	628 460 20 05 33305 01	Serie 400	566 x Ø36 x 30 
05.020.1911.790 Lenkstange Drag Rod 	8.226.355.0000 8.226.280.0000 23391 01	Serie 300	2163 x Ø48 x 30 
 Ersatzteil bzw. Rep.Satz spare part or rep.-kit	05.030.0907.019, Kugelgelenk Ball Joint 05.030.0907.029, Kugelgelenk Ball Joint		
05.020.1911.840 Lenkstange Drag Rod 	8.226.308.000 8.226.308.000 C 21540 01 23386 01	Serie 300, Serie 400	630 x Ø40 x 30 
 Ersatzteil bzw. Rep.Satz spare part or rep.-kit	05.030.0280.280, Kugelgelenk Ball Joint		

ST-Artikel ST-Article	Vergleichs-Nr. Comparison No.	passend für to fit to	Details Details
<p>05.020.1912.850</p> <p>Lenkstange Drag Rod</p> 	<p>628 460 19 05</p> <p>33306 01</p>	<p>Serie 400</p>	<p>651 x Ø38 x 30</p> 
<p>i Ersatzteil bzw. Rep.Satz spare part or rep.-kit</p>	<p>05.030.0907.019, Kugelgelenk Ball Joint 05.030.0907.029, Kugelgelenk Ball Joint</p>		
<p>05.030.0280.280</p> <p>Kugelgelenk Ball Joint</p> 	<p>6.851.529.000</p> <p>22535 01</p>	<p>Serie 400</p>	<p>120 x 30 / M30 x 1,5</p> 
<p>05.030.0907.019</p> <p>Kugelgelenk Ball Joint</p> 	<p>8.226.236.058</p> <p>6.851.485.000</p> <p>11492 03</p> <p>11492 02</p> <p>11390 01</p>	<p>Serie 400, Setra</p>	<p>125 x 30 / M30 x 1,5</p> 
<p>i Ersatzteil bzw. Rep.Satz spare part or rep.-kit</p>	<p>05.010.0280.900, Spurstange Tie Rod 05.010.0803.630, Spurstange Tie Rod 05.010.0994.510, Spurstange Tie Rod 05.010.1913.460, Spurstange Tie Rod 05.010.4007.067, Spurstange Tie Rod 05.010.4007.068, Spurstange Tie Rod 05.010.4256.320, Spurstange Tie Rod 05.010.4256.330, Spurstange Tie Rod 05.010.4256.350, Spurstange Tie Rod 05.020.0280.820, Lenkstange Drag Rod 05.020.0280.830, Lenkstange Drag Rod 05.020.0994.110, Lenkstange Drag Rod 05.020.0994.120, Lenkstange Drag Rod 05.020.0994.160, Lenkstange Drag Rod 05.020.0994.260, Lenkstange Drag Rod 05.020.0994.280, Lenkstange Drag Rod</p>		
<p>Komplementärteil complementary part</p>	<p>05.030.0907.029, Kugelgelenk Ball Joint</p>		

05.030.0907.029

Kugelgelenk
Ball Joint



8.226.236.059

11505 03

11505 02

11389 01

Serie 400, Setra

125 x 30 / M30 x 1,5



Ersatzteil bzw. Rep.Satz | spare part or rep.-kit

05.010.0280.900, Spurstange | Tie Rod
05.010.0803.630, Spurstange | Tie Rod
05.010.0994.510, Spurstange | Tie Rod
05.010.0994.550, Spurstange | Tie Rod
05.010.1913.460, Spurstange | Tie Rod
05.010.1913.510, Spurstange | Tie Rod
05.010.4007.067, Spurstange | Tie Rod
05.010.4007.068, Spurstange | Tie Rod
05.010.4256.320, Spurstange | Tie Rod
05.010.4256.330, Spurstange | Tie Rod
05.010.4256.350, Spurstange | Tie Rod
05.020.0280.390, Lenkstange | Drag Rod
05.020.0280.830, Lenkstange | Drag Rod
05.020.0803.760, Lenkstange | Drag Rod
05.020.0803.770, Lenkstange | Drag Rod
05.020.0803.780, Lenkstange | Drag Rod
05.020.0994.110, Lenkstange | Drag Rod
05.020.0994.120, Lenkstange | Drag Rod
05.020.0994.160, Lenkstange | Drag Rod
05.020.0994.170, Lenkstange | Drag Rod
05.020.0994.190, Lenkstange | Drag Rod
05.020.0994.260, Lenkstange | Drag Rod
05.020.0994.280, Lenkstange | Drag Rod
05.020.1913.250, Lenkstange | Drag Rod
05.020.1913.290, Lenkstange | Drag Rod
05.020.1913.330, Lenkstange | Drag Rod
05.020.1913.360, Lenkstange | Drag Rod
05.020.1913.370, Lenkstange | Drag Rod
05.020.1913.380, Lenkstange | Drag Rod
05.020.1913.410, Lenkstange | Drag Rod
05.020.4256.370, Lenkstange | Drag Rod

Komplementärteil | complementary part

05.030.0907.019, Kugelgelenk | Ball Joint

05.030.1907.209

Kugelgelenk
Ball Joint



6.851.517.000

11402 01

25718 01

24570 01

Serie 400

120 x 26 / M30 x 1,5



Ersatzteil bzw. Rep.Satz | spare part or rep.-kit

05.010.1913.500, Spurstange | Tie Rod
05.020.0280.800, Lenkstange | Drag Rod
05.020.0994.560, Lenkstange | Drag Rod
05.020.0994.570, Lenkstange | Drag Rod
05.020.1913.280, Lenkstange | Drag Rod
05.020.4007.084, Lenkstange | Drag Rod
05.020.4007.085, Lenkstange | Drag Rod

Komplementärteil | complementary part

05.030.1907.549, Kugelgelenk | Ball Joint

ST-Artikel ST-Article	Vergleichs-Nr. Comparison No.	passend für to fit to	Details Details
--------------------------	----------------------------------	--------------------------	--------------------

05.030.1907.980

Kugelgelenk
Ball Joint



6.851.533.000
6.851.447.000

11388 01

Setra

125 x 26 / M30 x 1,5



05.030.1910.700

Kugelgelenk
Ball Joint



000 460 57 48
000 460 60 48

11394 04
11394 03

Serie 400

125 x 32 / M30 x 1,5





Ersatzteil bzw. Rep.Satz | spare part or rep.-kit





Komplementärteil | complementary part

- 05.010.1913.430, Spurstange | Tie Rod
- 05.020.1913.210, Lenkstange | Drag Rod
- 05.020.1913.240, Lenkstange | Drag Rod
- 05.020.1913.260, Lenkstange | Drag Rod
- 05.020.1913.300, Lenkstange | Drag Rod
- 05.020.1913.350, Lenkstange | Drag Rod
- 05.020.1913.390, Lenkstange | Drag Rod
- 05.030.1910.440, Kugelgelenk | Ball Joint

passend für
to fit to
Solaris
Bus









ST-Artikel ST-Article	Vergleichs-Nr. Comparison No.	passend für to fit to	Details Details
05.030.1907.549	0820 352 213	Solaris	120 x 26 / M30 x 1,5
Kugelgelenk Ball Joint	11403 01		
	11728 01		
	19675 01		
			
 Komplementärteil complemen- tary part	05.030.1907.209, Kugelgelenk Ball Joint		
			

passend für
to fit to
Van Hool
Bus









ST-Artikel ST-Article	Vergleichs-Nr. Comparison No.	passend für to fit to	Details Details
05.030.0280.210 Kugelgelenk Ball Joint 	634 203 870 18461 01 31708 01	Van Hool	85 x 38 / M26 x 1,5 
05.030.1907.209 Kugelgelenk Ball Joint 	634301260 11402 01 25718 01 24570 01	Van Hool	120 x 26 / M30 x 1,5 
<i>i</i> Ersatzteil bzw. Rep.Satz spare part or rep.-kit Komplementärteil complementary part	05.010.1913.500, Spurstange Tie Rod 05.020.0280.800, Lenkstange Drag Rod 05.020.0994.560, Lenkstange Drag Rod 05.020.0994.570, Lenkstange Drag Rod 05.020.1913.280, Lenkstange Drag Rod 05.020.4007.084, Lenkstange Drag Rod 05.020.4007.085, Lenkstange Drag Rod 05.030.1907.549, Kugelgelenk Ball Joint		













passend für
to fit to
VDL Bova
Bus

ST-Artikel ST-Article	Vergleichs-Nr. Comparison No.	passend für to fit to	Details Details
05.010.0275.700 Spurstange Tie Rod 	1337 644 21807 01	SB 220	1742 x Ø40 x 26 
 Ersatzteil bzw. Rep.Satz spare part or rep.-kit	05.030.1907.209, Kugelgelenk Ball Joint 05.030.1907.549, Kugelgelenk Ball Joint		
05.010.0280.240 Spurstange Tie Rod 	1361 157 1295 415 23234 01 24816 01	SB 220, SB 250	1733 x Ø52 x 26 
 Ersatzteil bzw. Rep.Satz spare part or rep.-kit	05.030.0280.220, Kugelgelenk Ball Joint		
05.010.0780.016 Spurstange Tie Rod 	450495 185772 22361 01	Futura	855 x Ø40 x 30 
 Ersatzteil bzw. Rep.Satz spare part or rep.-kit	05.030.0907.029, Kugelgelenk Ball Joint		
05.010.0780.017 Spurstange Tie Rod 	450496 185771 22334 01	Futura	855 x Ø40 x 30 
 Ersatzteil bzw. Rep.Satz spare part or rep.-kit	05.030.0907.029, Kugelgelenk Ball Joint		

ST-Artikel ST-Article	Vergleichs-Nr. Comparison No.	passend für to fit to	Details Details
05.030.0780.003 Kugelgelenk Ball Joint 	41142071 19633 01	VDL Bova	120 x 25,5 / M30 x 1,5 
 Komplementärteil complemen- tary part	05.030.0780.004, Kugelgelenk Ball Joint		
05.030.3040.110 Kugelgelenk Ball Joint 	41149875 21440 01 11393 01	VDL Bova	150 x 30 / M30 x 1,5 
 Ersatzteil bzw. Rep.Satz spare part or rep.-kit	05.010.4256.360, Spurstange Tie Rod		
05.050.0278.110 Hydraulikpumpe, Lenkung Hydraulic Pump, Steering 	1291 227 367 352 7672.955.287 542 0014 10	SB 220, SB 250, SB 4000, SBR 4000	M26x1,5 / M16x1,5 

passend für
to fit to
Volvo
Bus

ST-Artikel ST-Article	Vergleichs-Nr. Comparison No.	passend für to fit to	Details Details
05.010.4002.620 Spurstange Tie Rod 	20 497 798 85 114 240 21270 01	B 10, B 12, B 7, B 9	300 x Ø36 x 28,6 
05.010.4007.028 Spurstange Tie Rod 	8156 123 26064 01	B 10, B 12	1674 x Ø42 x 28,6 
 Ersatzteil bzw. Rep.Satz spare part or rep.-kit	05.030.4002.439, Kugelgelenk Ball Joint 05.030.4002.449, Kugelgelenk Ball Joint		
05.010.4007.065 Spurstange Tie Rod 	1628 207 35333 01	B 10, B 9	368 x Ø38 x 28,6 
 Ersatzteil bzw. Rep.Satz spare part or rep.-kit	05.030.1912.610, Kugelgelenk Ball Joint		
05.020.4002.241 Lenkstange Drag Rod 	9522 701 29814 01	B 12	770 x Ø38 x 28,6 

ST-Artikel ST-Article	Vergleichs-Nr. Comparison No.	passend für to fit to	Details Details
05.020.4002.400 Lenkstange Drag Rod 	1197 338 11953 02	B 10, B 12	1028 x Ø62 x 31,5 
 Ersatzteil bzw. Rep.Satz spare part or rep.-kit	05.030.4002.480, Kugelgelenk Ball Joint		
05.020.4002.550 Lenkstange Drag Rod 	1197 339 25364 01	B 10, B 12	1028 x Ø62 x 31,5 
 Ersatzteil bzw. Rep.Satz spare part or rep.-kit	05.030.4002.480, Kugelgelenk Ball Joint		
05.020.4002.640 Lenkstange Drag Rod 	20 497 800 9959 153 21271 01	B 12	763 x Ø38 x 28,6 
 Ersatzteil bzw. Rep.Satz spare part or rep.-kit	05.030.4002.449, Kugelgelenk Ball Joint		
05.020.4004.700 Lenkstange Drag Rod 	3116 050 19553 01	Olympia - Serie	1822 x Ø50 x 31,5 
 Ersatzteil bzw. Rep.Satz spare part or rep.-kit	05.030.4002.480, Kugelgelenk Ball Joint		

ST-Artikel ST-Article	Vergleichs-Nr. Comparison No.	passend für to fit to	Details Details
05.020.4004.730 Lenkstange Drag Rod 	20 745 923 20 490 123 22024 02	B 10, B 12, B 13	1030 x Ø62 x 28,6 
 Ersatzteil bzw. Rep.Satz spare part or rep.-kit	05.030.4007.038, Kugelgelenk Ball Joint		
05.020.4004.930 Lenkstange Drag Rod 	85 104 265 3098 294 23568 01	B 7, B 9, Olympia - Serie	495 x Ø40 x 28,6 
05.020.4004.980 Lenkstange Drag Rod 	1626 672 1194 824 23538 01	B 10, B 12	822 x Ø42 x 31,5 
 Ersatzteil bzw. Rep.Satz spare part or rep.-kit	05.030.4002.450, Kugelgelenk Ball Joint 05.030.4002.480, Kugelgelenk Ball Joint		
05.020.4007.018 Lenkstange Drag Rod 	21 308 024 20 745 924 21572 02 21572 01	B 10, B 12, B 13	1026 x Ø60 x 28,6 
 Ersatzteil bzw. Rep.Satz spare part or rep.-kit	05.030.4007.038, Kugelgelenk Ball Joint		

ST-Artikel ST-Article	Vergleichs-Nr. Comparison No.	passend für to fit to	Details Details
--------------------------	----------------------------------	--------------------------	--------------------

05.020.4007.023

Lenkstange
Drag Rod



20 497 799
9959 152
21272 01

B 10, B 12, B 7, B 9

743 x Ø40 x 28,6



05.030.0907.019

Kugelgelenk
Ball Joint



20 742 129
11492 03
11492 02
11390 01

Volvo

125 x 30 / M30 x 1,5



i Ersatzteil bzw. Rep.Satz | spare part or rep.-kit

- 05.010.0280.900, Spurstange | Tie Rod
- 05.010.0803.630, Spurstange | Tie Rod
- 05.010.0994.510, Spurstange | Tie Rod
- 05.010.1913.460, Spurstange | Tie Rod
- 05.010.4007.067, Spurstange | Tie Rod
- 05.010.4007.068, Spurstange | Tie Rod
- 05.010.4256.320, Spurstange | Tie Rod
- 05.010.4256.330, Spurstange | Tie Rod
- 05.010.4256.350, Spurstange | Tie Rod
- 05.020.0280.820, Lenkstange | Drag Rod
- 05.020.0280.830, Lenkstange | Drag Rod
- 05.020.0994.110, Lenkstange | Drag Rod
- 05.020.0994.120, Lenkstange | Drag Rod
- 05.020.0994.160, Lenkstange | Drag Rod
- 05.020.0994.260, Lenkstange | Drag Rod
- 05.020.0994.280, Lenkstange | Drag Rod

Komplementärteil | complementary part

05.030.0907.029, Kugelgelenk | Ball Joint

05.030.0907.029

Kugelgelenk
Ball Joint



20 742 127

11505 03

11505 02

11389 01

Volvo

125 x 30 / M30 x 1,5



Ersatzteil bzw. Rep.Satz | spare part or rep.-kit

05.010.0280.900, Spurstange | Tie Rod
05.010.0803.630, Spurstange | Tie Rod
05.010.0994.510, Spurstange | Tie Rod
05.010.0994.550, Spurstange | Tie Rod
05.010.1913.460, Spurstange | Tie Rod
05.010.1913.510, Spurstange | Tie Rod
05.010.4007.067, Spurstange | Tie Rod
05.010.4007.068, Spurstange | Tie Rod
05.010.4256.320, Spurstange | Tie Rod
05.010.4256.330, Spurstange | Tie Rod
05.010.4256.350, Spurstange | Tie Rod
05.020.0280.390, Lenkstange | Drag Rod
05.020.0280.830, Lenkstange | Drag Rod
05.020.0803.760, Lenkstange | Drag Rod
05.020.0803.770, Lenkstange | Drag Rod
05.020.0803.780, Lenkstange | Drag Rod
05.020.0994.110, Lenkstange | Drag Rod
05.020.0994.120, Lenkstange | Drag Rod
05.020.0994.160, Lenkstange | Drag Rod
05.020.0994.170, Lenkstange | Drag Rod
05.020.0994.190, Lenkstange | Drag Rod
05.020.0994.260, Lenkstange | Drag Rod
05.020.0994.280, Lenkstange | Drag Rod
05.020.1913.250, Lenkstange | Drag Rod
05.020.1913.290, Lenkstange | Drag Rod
05.020.1913.330, Lenkstange | Drag Rod
05.020.1913.360, Lenkstange | Drag Rod
05.020.1913.370, Lenkstange | Drag Rod
05.020.1913.380, Lenkstange | Drag Rod
05.020.1913.410, Lenkstange | Drag Rod
05.020.4256.370, Lenkstange | Drag Rod

Komplementärteil | complementary part

05.030.0907.019, Kugelgelenk | Ball Joint

05.030.1907.180

Kugelgelenk
Ball Joint



1518 142

1190 778

11376 02

11376 01

19667 01

B 12, B 13







95 x 20 / M24 x 1,5



Komplementärteil | complementary part

05.030.1907.190, Kugelgelenk | Ball Joint

ST-Artikel ST-Article	Vergleichs-Nr. Comparison No.	passend für to fit to	Details Details
05.030.4002.411 Kugelgelenk Ball Joint 	1527 234 0382 745 11954 01	B 10, B 7	87 x 16 / M28 x 1,5 
05.030.4002.439 Kugelgelenk Ball Joint 	1698 847 1698 533 11947 02	B 10, B 12, B 6, B 7, B 9, 7700, 8500, 8700, 9700	125 x 28,6 / M30 x 1,5 
<i>i</i> Komplementärteil complementary part	05.030.4002.449, Kugelgelenk Ball Joint		
05.030.4002.449 Kugelgelenk Ball Joint 	1698 846 1698 532 11946 02	B 10, B 12, B 6, B 7, B 9, 7700, 8500, 8700, 9700	125 x 28,6 / M30 x 1,5 
<i>i</i> Ersatzteil bzw. Rep.Satz spare part or rep.-kit Komplementärteil complementary part	05.020.4007.070, Lenkstange Drag Rod 05.020.4007.071, Lenkstange Drag Rod 05.020.4007.074, Lenkstange Drag Rod 05.030.4002.439, Kugelgelenk Ball Joint		
05.030.4002.450 Kugelgelenk Ball Joint 	85 114 147 1698 840 11945 01 11945 02	B 10, B 12, Olympia - Serie	125 x 31,5 / M30 x 1,5 
<i>i</i> Komplementärteil complementary part	05.030.4002.480, Kugelgelenk Ball Joint		

ST-Artikel ST-Article	Vergleichs-Nr. Comparison No.	passend für to fit to	Details Details
05.030.4002.460 Kugelgelenk Ball Joint 	6889 484 1699 401 11968 01	B 10, B 7	167 x 28,6 / M52 x 1,5 
 Komplementärteil complemen- tary part	05.030.4002.470, Kugelgelenk Ball Joint		
05.030.4002.470 Kugelgelenk Ball Joint 	6889 483 1699 400 11967 01	B 10, B 7	167 x 28,6 / M52 x 1,5 
 Komplementärteil complemen- tary part	05.030.4002.460, Kugelgelenk Ball Joint		
05.030.4002.480 Kugelgelenk Ball Joint 	85 114 146 1695 776 11944 01 11944 02	B 10, Olympia - Serie	125 x 31,5 / M30 x 1,5 
 Komplementärteil complemen- tary part	05.030.4002.450, Kugelgelenk Ball Joint		
05.030.4007.038 Kugelgelenk Ball Joint 	3093 647 27547 02	B 12, B 7, B 9	140 x 28,6 / M30 x 1,5 
 Ersatzteil bzw. Rep.Satz spare part or rep.-kit	05.010.4007.064, Spurstange Tie Rod 05.010.4007.066, Spurstange Tie Rod 05.020.4007.072, Lenkstange Drag Rod 05.020.4007.079, Lenkstange Drag Rod 05.020.4007.081, Lenkstange Drag Rod		

ST-Artikel ST-Article	Vergleichs-Nr. Comparison No.	passend für to fit to	Details Details
05.030.4007.042 Kugelgelenk Ball Joint 	3193 731 28792 01	B 12	120 x 28,8 / M26 x 1,5 
05.030.4007.046 Kugelgelenk Ball Joint 	3987 648 27634 01	B 12	88 x 28,6 / M26 x 1,5 
05.030.4002.412 Trag-/Führungsgelenk Ball Joint 	20 994 563 20 739 867 29548 01	B 12	158 x 42 / M85 x 1,5 
05.050.4014.000 Hydraulikpumpe, Lenkung Hydraulic Pump, Steering 	20 453 450 8694.974.519	B 9	M26x1,5 / M16x1,5 

ST-Artikel
ST-Article

Vergleichs-Nr.
Comparison No.

passend für
to fit to

Details
Details

05.050.4014.020

Hydraulikpumpe, Lenkung
Hydraulic Pump, Steering



20 453 453
20 482 481
7684.955.763

B 9

M26x1,5 / M16x1,5



05.050.4014.030

Hydraulikpumpe, Lenkung
Hydraulic Pump, Steering



1589 925
5001 933
7673.955.202

B 6, B 7

M26x1,5 / M16x1,5



05.050.4014.040

Hydraulikpumpe, Lenkung
Hydraulic Pump, Steering



1585 013
5001 934
7673.955.211

B 10

M26x1,5 / M16x1,5



passend für
to fit to

Iveco

Kleintransporter
Light commercial vehicle



passend für | to fit to Iveco

ST-Artikel
ST-Article

Vergleichs-Nr.
Comparison No.

passend für
to fit to

Details
Details

05.030.0803.660

Trag-/Führungsgelenk
Ball Joint



9380 7545

9380 2242

35016 01

11639 01

Daily I, Daily II, Daily III, Daily IV













115 x 26 / M28 x 1,5

























passend für
to fit to

Mercedes-Benz

Kleintransporter
Light commercial vehicle

ST-Artikel ST-Article	Vergleichs-Nr. Comparison No.	passend für to fit to	Details Details
05.010.1910.200 Spurstange Tie Rod 	602 330 09 03 602 330 10 03 11450 01	T1 (602)	1350 x Ø30 x 18 
	Ersatzteil bzw. Rep.Satz spare part or rep.-kit	05.030.1907.790, Kugelgelenk Ball Joint	
05.010.1910.210 Spurstange Tie Rod 	602 330 03 03 602 330 04 03 11449 02	T1 (602), T1/TN	1345 x Ø32 x 18 
	Ersatzteil bzw. Rep.Satz spare part or rep.-kit	05.030.1907.770, Kugelgelenk Ball Joint 05.030.1907.780, Kugelgelenk Ball Joint	
05.010.1910.450 Spurstange Tie Rod 	638 460 02 05 25459 01	Vito (W638)	400 x Ø18 x 20 
	Ersatzteil bzw. Rep.Satz spare part or rep.-kit	05.030.1980.870, Kugelgelenk Ball Joint	
05.010.1910.460 Spurstange Tie Rod 	901 460 02 05 901 460 04 55 27756 01	Sprinter 2-t (901, 902), Sprinter 3-t (903), Sprinter 4-t (904)	385 x Ø18 x 20 
	Ersatzteil bzw. Rep.Satz spare part or rep.-kit	05.030.1980.880, Kugelgelenk Ball Joint	

ST-Artikel ST-Article	Vergleichs-Nr. Comparison No.	passend für to fit to	Details Details
05.010.1910.590 Spurstange Tie Rod 	631 330 06 03 12843 01	100 (631)	660 x Ø30 x 22 
05.010.1910.770 Spurstange Tie Rod 	631 330 07 03 631 330 05 03 12841 01	100 (631)	300 x Ø26 x 20 
 Ersatzteil bzw. Rep.Satz spare part or rep.-kit	05.030.1910.890, Kugelgelenk Ball Joint 05.030.1980.900, Kugelgelenk Ball Joint		
05.010.1910.780 Spurstange Tie Rod 	631 460 07 05 12845 01	100 (631)	1236 x Ø35 x 18 
05.010.1911.680 Spurstange Tie Rod 	670 330 06 03 670 330 03 03 12877 01	T2/L, Vario	1594 x Ø35 x 22 
 Ersatzteil bzw. Rep.Satz spare part or rep.-kit	05.030.1907.410, Kugelgelenk Ball Joint 05.030.1980.860, Kugelgelenk Ball Joint		













ST-Artikel ST-Article	Vergleichs-Nr. Comparison No.	passend für to fit to	Details Details
05.010.1912.400 Spurstange Tie Rod 	667 330 06 03 667 330 05 03 20898 01	T2/L, Vario	1600 x Ø36 x 18 
 Ersatzteil bzw. Rep.Satz spare part or rep.-kit	05.030.1907.770, Kugelgelenk Ball Joint 05.030.1907.780, Kugelgelenk Ball Joint		
05.010.1913.480 Spurstange Tie Rod 	669 330 06 03 669 330 07 03 23962 01	Vario	1501 x Ø44 x 22 
 Ersatzteil bzw. Rep.Satz spare part or rep.-kit	05.030.1907.120, Kugelgelenk Ball Joint		
05.020.1907.640 Lenkstange Drag Rod 	309 460 32 05 309 460 31 05 30908 01	T1 (602), T2/L	470 x Ø28 x 18 
 Ersatzteil bzw. Rep.Satz spare part or rep.-kit	05.030.1907.230, Kugelgelenk Ball Joint		
05.020.1910.240 Lenkstange Drag Rod 	668 460 09 05 668 460 11 05 11473 01	T2/LN1	505 x Ø28 x 18 
 Ersatzteil bzw. Rep.Satz spare part or rep.-kit	05.030.1907.170, Kugelgelenk Ball Joint		





ST-Artikel ST-Article	Vergleichs-Nr. Comparison No.	passend für to fit to	Details Details
05.020.1910.250 Lenkstange Drag Rod 	670 460 26 05 670 460 27 05 12933 01	T2/LN1	495 x Ø32 x 22 
 Ersatzteil bzw. Rep.Satz spare part or rep.-kit	05.030.1907.120, Kugelgelenk Ball Joint		
05.020.1910.260 Lenkstange Drag Rod 	601 460 15 05 601 460 13 05 11448 01	T1 (602), T1/TN	450 x Ø28 x 18 
 Ersatzteil bzw. Rep.Satz spare part or rep.-kit	05.030.1907.230, Kugelgelenk Ball Joint		
05.020.1910.740 Lenkstange Drag Rod 	668 460 21 05 668 460 22 05 13575 01	T2/LN1	490 x Ø28 x 18 
 Ersatzteil bzw. Rep.Satz spare part or rep.-kit	05.030.1907.170, Kugelgelenk Ball Joint		
05.020.1910.760 Lenkstange Drag Rod 	670 460 20 05 670 460 16 05 12931 01	T2/LN1	513 x Ø32 x 22 
 Ersatzteil bzw. Rep.Satz spare part or rep.-kit	05.030.1907.120, Kugelgelenk Ball Joint		

ST-Artikel ST-Article	Vergleichs-Nr. Comparison No.	passend für to fit to	Details Details
05.020.1910.810 Lenkstange Drag Rod 	670 460 28 05 670 460 29 05 12934 01	T2/LN1	500 x Ø32 x 22 
	Ersatzteil bzw. Rep.Satz spare part or rep.-kit	05.030.1907.120, Kugelgelenk Ball Joint	
05.020.1911.640 Lenkstange Drag Rod 	667 460 15 05 667 460 17 05 24911 01	Vario	510 x Ø35 x 22 
	Ersatzteil bzw. Rep.Satz spare part or rep.-kit	05.030.1907.120, Kugelgelenk Ball Joint	
05.020.1911.910 Lenkstange Drag Rod 	667 460 16 05 667 460 18 05 24581 01	Vario	504 x Ø34 x 22 
	Ersatzteil bzw. Rep.Satz spare part or rep.-kit	05.030.1907.120, Kugelgelenk Ball Joint	
05.020.1912.540 Lenkstange Drag Rod 	667 460 07 05 667 460 10 05 24210 01	T2/LN1	505 x Ø26 x 18 
	Ersatzteil bzw. Rep.Satz spare part or rep.-kit	05.030.1907.230, Kugelgelenk Ball Joint	

ST-Artikel ST-Article	Vergleichs-Nr. Comparison No.	passend für to fit to	Details Details
05.030.1907.130 Kugelgelenk Ball Joint	001 330 07 35 001 330 09 35 30902 01 11405 01	T2/L	160 x 18 / M24 x 1,5
	 Komplementärteil complemen- tary part 05.030.1907.140, Kugelgelenk Ball Joint		
05.030.1907.140 Kugelgelenk Ball Joint	001 330 08 35 001 330 10 35 30903 01 11406 01	T2/L	160 x 18 / M24 x 1,5
	 Komplementärteil complemen- tary part 05.030.1907.130, Kugelgelenk Ball Joint		
05.030.1907.170 Kugelgelenk Ball Joint	001 330 14 35 001 330 12 35 11407 01	T2/LN1	96 x 18 / M24 x 1,5
			
05.030.1907.230 Kugelgelenk Ball Joint	000 460 85 48 000 460 45 48 11391 01	T1 (602), T1/TN, T2/L	95 x 18 / M22 x 1,5
			

ST-Artikel ST-Article	Vergleichs-Nr. Comparison No.	passend für to fit to	Details Details
05.030.1907.410 Kugelgelenk Ball Joint 	000 330 98 35 001 330 00 35 11381 01	T2/L, Vario	106 x 22 / M24 x 1,5 
05.030.1907.770 Kugelgelenk Ball Joint 	601 330 04 35 601 330 06 35 11446 01	T1 (602), T1/TN, T2/LN1	92 x 18 / M20 x 1,5 
 Komplementärteil complemen- tary part	05.030.1907.780, Kugelgelenk Ball Joint		
05.030.1907.780 Kugelgelenk Ball Joint 	601 330 05 35 601 330 07 35 11447 01 11447 02	T1 (602), T2/LN1	92 x 18 / M20 x 1,5 
 Komplementärteil complemen- tary part	05.030.1907.770, Kugelgelenk Ball Joint		
05.030.1907.790 Kugelgelenk Ball Joint 	602 330 58 35 602 330 60 35 11452 01	T1 (601), T1 (602)	115 x 18 / M24 x 1,5 

ST-Artikel ST-Article	Vergleichs-Nr. Comparison No.	passend für to fit to	Details Details
05.030.1910.890 Kugelgelenk Ball Joint 	631 330 04 35 12838 01	100 (631)	100 x 20 / M20 x 1,5 
 Komplementärteil complemen- tary part	05.030.1980.900, Kugelgelenk Ball Joint		
05.030.1910.920 Kugelgelenk Ball Joint 	310 330 20 35 310 330 24 35 12836 01	T2/L	160 x 20 / M24 x 1,5 
 Komplementärteil complemen- tary part	05.030.1910.930, Kugelgelenk Ball Joint		
05.030.1910.930 Kugelgelenk Ball Joint 	310 330 21 35 310 330 25 35 12837 01	T2/L	160 x 10 / M24 x 1,5 
 Komplementärteil complemen- tary part	05.030.1910.920, Kugelgelenk Ball Joint		
05.030.1910.940 Kugelgelenk Ball Joint 	310 330 22 35 310 330 26 35 19702 01	T2/L	190 x 20 / M24 x 1,5 
 Komplementärteil complemen- tary part	05.030.1910.950, Kugelgelenk Ball Joint		

ST-Artikel ST-Article	Vergleichs-Nr. Comparison No.	passend für to fit to	Details Details
05.030.1910.950 Kugelgelenk Ball Joint 	310 330 23 35 310 330 27 35 19703 01	T2/L	190 x 20 / M24 x 1,5 
 Komplementärteil complementary part	05.030.1910.940, Kugelgelenk Ball Joint		
05.030.1912.790 Kugelgelenk Ball Joint 	906 460 00 48 906 460 01 48 31148 01	Sprinter 3-t (906), Sprinter 3,5-t (906), Sprinter 4,6-t (906), Sprinter 5-t (906)	90 x 16,8 / M16 X 1,5 
05.030.1980.840 Kugelgelenk Ball Joint 	631 338 03 10 12839 01	100 (631)	92 x 18,2 / M18 x 1,5 
 Komplementärteil complementary part	05.030.1980.850, Kugelgelenk Ball Joint		
05.030.1980.850 Kugelgelenk Ball Joint 	631 338 04 10 12840 01	100 (631)	92 x 18,2 / M18 x 1,5 
 Komplementärteil complementary part	05.030.1980.840, Kugelgelenk Ball Joint		

ST-Artikel ST-Article	Vergleichs-Nr. Comparison No.	passend für to fit to	Details Details
<p>05.030.1980.860 Kugelgelenk Ball Joint</p>  <p><i>i</i> Komplementärteil complemen- tary part</p>	<p>000 330 97 35 000 330 12 35</p> <p>11380 01 19674 01 11380 02</p>	<p>T2/LN1, Vario</p>	<p>106 x 22 / M24 x 1,5</p> 
<p>05.030.1980.870 Kugelgelenk Ball Joint</p> 	<p>638 460 00 48</p> <p>18874 03</p>	<p>Vito (W638)</p>	<p>75 x 22 / M16 x 1,5</p> 
<p>05.030.1980.880 Kugelgelenk Ball Joint</p> 	<p>901 460 03 48 901 460 00 48</p> <p>19719 02</p>	<p>Sprinter 2-t (901, 902), Sprin- ter 3-t (903), Sprinter 4-t (904)</p>	<p>80 x 20 / M16 x 1,5</p> 
<p>05.030.1980.900 Kugelgelenk Ball Joint</p>  <p><i>i</i> Komplementärteil complemen- tary part</p>	<p>631 338 05 10 001 330 48 35</p>	<p>100 (631)</p>	<p>100 x 20 / M20 x 1,5</p> 

ST-Artikel
ST-Article

Vergleichs-Nr.
Comparison No.

passend für
to fit to

Details
Details

05.030.1980.770

Trag-/Führungsgelenk
Ball Joint



631 320 02 28
631 320 00 28

11462 01

T1 (602), 100 (631)

103 x 22 / M16 x 1,5



05.030.1980.830

Trag-/Führungsgelenk
Ball Joint



901 333 12 27
901 333 11 27

18875 03

Sprinter 2-t (901, 902), Sprinter 3-t (903), Sprinter 4-t (904), Sprinter 5-t(905)

M20 x 1,5



05.050.1915.090

Hydraulikpumpe, Lenkung
Hydraulic Pump, Steering



000 460 94 80
001 460 42 80

7684.955.182

Vario

M26x1,5 / M18x1,5



05.050.1915.180

Hydraulikpumpe, Lenkung
Hydraulic Pump, Steering



003 466 72 01
003 466 71 01

7692 900 530
541 0231 10

Sprinter 3-t (906), Sprinter 3,5-t (906), Sprinter 4,6-t (906), Sprinter 5-t (906), Viano (W639), Vito (W639)



ST-Artikel
ST-Article

Vergleichs-Nr.
Comparison No.

passend für
to fit to

Details
Details

05.050.1915.190

Hydraulikpumpe, Lenkung
Hydraulic Pump, Steering



003 466 07 01
002 466 26 01

7692 900 504
542 0035 10



Sprinter 2-t (901, 902), Sprin-
ter 3-t (903), Sprinter 4-t (904)



passend für
to fit to

Renault Trucks

Kleintransporter
Light commercial vehicle

ST-Artikel ST-Article	Vergleichs-Nr. Comparison No.	passend für to fit to	Details Details
05.030.1907.180 Kugelgelenk Ball Joint	5001 844 136 5000 814 097 11376 02 11376 01 19667 01	Messenger	95 x 20 / M24 x 1,5
			
 Komplementärteil complemen- tary part	05.030.1907.190, Kugelgelenk Ball Joint		

passend für
to fit to

Volkswagen

Kleintransporter
Light commercial vehicle

ST-Artikel ST-Article	Vergleichs-Nr. Comparison No.	passend für to fit to	Details Details
05.010.1910.460 Spurstange Tie Rod 	2D0 422 803 27756 01	LT 28-35 II, LT 28-46 II	385 x Ø18 x 20 
 Ersatzteil bzw. Rep.Satz spare part or rep.-kit	05.030.1980.880, Kugelgelenk Ball Joint		
05.030.1912.790 Kugelgelenk Ball Joint 	2E0 498 104 2E0 498 104 A 31148 01	Crafter (2E_), Crafter (2F_)	90 x 16,8 / M16 X 1,5 
05.030.1980.880 Kugelgelenk Ball Joint 	2D0 422 811 19719 02	LT 28-35 II, LT 28-46 II	80 x 20 / M16 x 1,5 
05.030.1980.830 Trag-/Führungsgelenk Ball Joint 	2D0 407 361 A 18875 03	LT 28-35 II, LT 28-46 II	M20 x 1,5 









passend für
to fit to
DAF
LKW
Truck

ST-Artikel ST-Article	Vergleichs-Nr. Comparison No.	passend für to fit to	Details Details
05.010.0269.990 Spurstange Tie Rod 	1353 396 1286 343 37451 01 21805 01	CF 75, CF 85, XF 105, XF 95, 75 CF, 85 CF, 95 XF	1698 x Ø52 x 26 
 Ersatzteil bzw. Rep.Satz spare part or rep.-kit	05.030.0280.220, Kugelgelenk Ball Joint		
05.010.0275.700 Spurstange Tie Rod 	1337 644 1270 854 21807 01	CF 65, CF 75, CF 85, LF 55, XF 105, XF 95, 65 CF, 75 CF, 85, 85 CF, 95 XF	1742 x Ø40 x 26 
 Ersatzteil bzw. Rep.Satz spare part or rep.-kit	05.030.1907.209, Kugelgelenk Ball Joint 05.030.1907.549, Kugelgelenk Ball Joint		
05.010.0280.050 Spurstange Tie Rod 	1353 391 1270 853 20593 01	CF 65, CF 75, CF 85, LF 55, XF 105, XF 95, 65 CF, 75 CF, 85, 85 CF, 95 XF	1690 x Ø40 x 26 
 Ersatzteil bzw. Rep.Satz spare part or rep.-kit	05.030.1907.209, Kugelgelenk Ball Joint 05.030.1907.549, Kugelgelenk Ball Joint		
05.010.0280.051 Spurstange Tie Rod 	1353 395 1351 205 27850 01	CF 75, CF 85, XF 105, XF 95, 95 XF	1646 x Ø40 x 26 
 Ersatzteil bzw. Rep.Satz spare part or rep.-kit	05.030.1907.209, Kugelgelenk Ball Joint 05.030.1907.549, Kugelgelenk Ball Joint		

ST-Artikel ST-Article	Vergleichs-Nr. Comparison No.	passend für to fit to	Details Details
05.010.0280.310 Spurstange Tie Rod 	1361 155 1297 572 21592 01	CF 75, CF 85, XF 105, XF 95, 95 XF	1512 x Ø52 x 26 
 Ersatzteil bzw. Rep.Satz spare part or rep.-kit	05.030.0280.220, Kugelgelenk Ball Joint		
05.010.0280.320 Spurstange Tie Rod 	1286 342 275 962 21804 01	75 CF, 85 CF, 95 XF	1686 x Ø52 x 30 
 Ersatzteil bzw. Rep.Satz spare part or rep.-kit	05.030.0907.130, Kugelgelenk Ball Joint		
05.010.0280.380 Spurstange Tie Rod 	1286 341 23238 01	75 CF, 95, 95 XF	1685 x Ø52 x 30 
 Ersatzteil bzw. Rep.Satz spare part or rep.-kit	05.030.0907.130, Kugelgelenk Ball Joint		
05.010.0280.540 Spurstange Tie Rod 	1700 001 33981 01	CF 65, CF 75, CF 85, XF 105	1734 x Ø40 x 30 
 Ersatzteil bzw. Rep.Satz spare part or rep.-kit	05.030.0907.019, Kugelgelenk Ball Joint 05.030.0907.029, Kugelgelenk Ball Joint		

ST-Artikel ST-Article	Vergleichs-Nr. Comparison No.	passend für to fit to	Details Details
05.010.0280.580 Spurstange Tie Rod 	1700 000 33980 01	CF 65, CF 75, CF 85, XF 105, XF 95	1690 x Ø40 x 30 
 Ersatzteil bzw. Rep.Satz spare part or rep.-kit	05.030.0907.019, Kugelgelenk Ball Joint 05.030.0907.029, Kugelgelenk Ball Joint		
05.010.0280.900 Spurstange Tie Rod 	1732 972 33978 01	CF 75, CF 85, XF 105	1646 x Ø40 x 30 
 Ersatzteil bzw. Rep.Satz spare part or rep.-kit	05.030.0907.019, Kugelgelenk Ball Joint 05.030.0907.029, Kugelgelenk Ball Joint		
05.010.0280.910 Spurstange Tie Rod 	1732 980 37232 01 33979 01	CF 75, CF 85, XF 105	1522 x Ø52 x 30 
 Ersatzteil bzw. Rep.Satz spare part or rep.-kit	05.030.0993.860, Kugelgelenk Ball Joint		
05.020.0275.590 Lenkstange Drag Rod 	1283 203 23333 01	95 XF	990 x Ø52 x 26 
 Ersatzteil bzw. Rep.Satz spare part or rep.-kit	05.030.1907.209, Kugelgelenk Ball Joint		

ST-Artikel ST-Article	Vergleichs-Nr. Comparison No.	passend für to fit to	Details Details
05.020.0275.600 Lenkstange Drag Rod 	094 038 525 433	95	1015 x Ø50 x 30 
 Ersatzteil bzw. Rep.Satz spare part or rep.-kit	05.030.0907.029, Kugelgelenk Ball Joint		
05.020.0275.610 Lenkstange Drag Rod 	1351 734 1385 499 22296 01	XF 95, 75 CF, 95 XF	1005 x Ø52 x 26 
 Ersatzteil bzw. Rep.Satz spare part or rep.-kit	05.030.1907.209, Kugelgelenk Ball Joint		
05.020.0275.630 Lenkstange Drag Rod 	094 006 0094 006	95	620 x Ø40 x 30 
 Ersatzteil bzw. Rep.Satz spare part or rep.-kit	05.030.0907.029, Kugelgelenk Ball Joint		
05.020.0275.690 Lenkstange Drag Rod 	1351 730 1351 745 21784 01	75 CF	622 x Ø42 x 26 
 Ersatzteil bzw. Rep.Satz spare part or rep.-kit	05.030.1907.209, Kugelgelenk Ball Joint		





ST-Artikel ST-Article	Vergleichs-Nr. Comparison No.	passend für to fit to	Details Details
05.020.0275.750 Lenkstange Drag Rod 	1401 937 34025 01	LF 55	910 x Ø40 x 26 
05.020.0280.130 Lenkstange Drag Rod 	1351 731 1385 506 19588 01	75 CF, 85 CF	1658 x Ø52 x 26 
05.020.0280.131 Lenkstange Drag Rod 	1433 449 1451 121 30998 01	CF 75, CF 85, 85 CF	1815 x Ø42 x 30 
05.020.0280.132 Lenkstange Drag Rod 	1351 742 1311 449 23338 01	95 XF	1766 x Ø52 x 26 

ST-Artikel ST-Article	Vergleichs-Nr. Comparison No.	passend für to fit to	Details Details
05.020.0280.133 Lenkstange Drag Rod 	1451 123 26829 01	CF 75, CF 85, XF 105, XF 95, 85 CF	1015 x Ø32 x 30 
<p>i Ersatzteil bzw. Rep.Satz spare part or rep.-kit 05.030.0280.111, Kugelgelenk Ball Joint</p>			
05.020.0280.134 Lenkstange Drag Rod 	1433 448 1451 120 26843 01	CF 75, CF 85	1815 x Ø42 x 30 
05.020.0280.135 Lenkstange Drag Rod 	1351 722 1385 509 21770 01	75 CF	1673 x Ø42 x 26 
05.020.0280.136 Lenkstange Drag Rod 	1405 499 34028 01	CF 65, LF 55	925 x Ø46 x 30 









ST-Artikel ST-Article	Vergleichs-Nr. Comparison No.	passend für to fit to	Details Details
05.020.0280.137 Lenkstange Drag Rod 	1426 101 094 613 26830 01	CF 85, XF 105, XF 95	1004 x Ø52 x 30 
 Ersatzteil bzw. Rep.Satz spare part or rep.-kit	05.030.0907.029, Kugelgelenk Ball Joint		
05.020.0280.138 Lenkstange Drag Rod 	1351 739 1385 516 23336 01	95 XF	1955 x Ø42 x 26 
05.020.0280.139 Lenkstange Drag Rod 	1395 995 33982 01	XF 105, XF 95	1000 x Ø52 x 30 
 Ersatzteil bzw. Rep.Satz spare part or rep.-kit	05.030.0907.029, Kugelgelenk Ball Joint		
05.020.0280.150 Lenkstange Drag Rod 	1700 913 1406 600 34035 01	LF 45	900 x Ø38 x 22 
 Ersatzteil bzw. Rep.Satz spare part or rep.-kit	05.030.0280.300, Kugelgelenk Ball Joint		











ST-Artikel ST-Article	Vergleichs-Nr. Comparison No.	passend für to fit to	Details Details
05.020.0280.260 Lenkstange Drag Rod 	1351 735 1385 500 23334 01	95 XF	1008 x Ø62 x 26 
	Ersatzteil bzw. Rep.Satz spare part or rep.-kit	05.030.1907.209, Kugelgelenk Ball Joint	
05.020.0280.350 Lenkstange Drag Rod 	1700 912 1407 144 34034 01	LF 45	900 x Ø38 x 22 
	Ersatzteil bzw. Rep.Satz spare part or rep.-kit	05.030.0280.300, Kugelgelenk Ball Joint	
05.020.0280.390 Lenkstange Drag Rod 	1426 101 15107 01 26830 01	CF 85, XF 105, XF 95	1008 x Ø52 x 30 
	Ersatzteil bzw. Rep.Satz spare part or rep.-kit	05.030.0907.029, Kugelgelenk Ball Joint	
05.020.0280.400 Lenkstange Drag Rod 	1395 994 26826 01	CF 85, XF 105, XF 95	991 x Ø50 x 30 
	Ersatzteil bzw. Rep.Satz spare part or rep.-kit	05.030.0907.029, Kugelgelenk Ball Joint	

ST-Artikel ST-Article	Vergleichs-Nr. Comparison No.	passend für to fit to	Details Details
05.020.0280.430 Lenkstange Drag Rod 	1269 973 1274 352 23332 01	XF 95, 75 CF	1328 x Ø30 x 26 
 Ersatzteil bzw. Rep.Satz spare part or rep.-kit	05.030.0280.113, Kugelgelenk Ball Joint		
05.020.0280.450 Lenkstange Drag Rod 	890 992 19785 01	LF 45	715 x Ø42 x 30 
 Ersatzteil bzw. Rep.Satz spare part or rep.-kit	05.030.0907.029, Kugelgelenk Ball Joint		
05.020.0280.470 Lenkstange Drag Rod 	1306 332 1351 740 21542 01	95 XF	1018 x Ø30 x 26 
 Ersatzteil bzw. Rep.Satz spare part or rep.-kit	05.030.0280.113, Kugelgelenk Ball Joint		
05.020.0280.480 Lenkstange Drag Rod 	1602 821 1363 859 26841 01	CF 65, CF 75, CF 85	867 x Ø50 x 30 
 Ersatzteil bzw. Rep.Satz spare part or rep.-kit	05.030.0907.029, Kugelgelenk Ball Joint		











ST-Artikel ST-Article	Vergleichs-Nr. Comparison No.	passend für to fit to	Details Details
05.020.0280.490 Lenkstange Drag Rod 	1602 820 1448 062 30290 01	CF 65, CF 75, CF 85	855 x Ø50 x 30 
 Ersatzteil bzw. Rep.Satz spare part or rep.-kit	05.030.0907.029, Kugelgelenk Ball Joint		
05.020.0280.510 Lenkstange Drag Rod 	1395 993 26831 01	XF 105, XF 95	996 x Ø38 x 30 
 Ersatzteil bzw. Rep.Satz spare part or rep.-kit	05.030.0907.029, Kugelgelenk Ball Joint		
05.020.0280.530 Lenkstange Drag Rod 	1396 000 26833 01	XF 105, XF 95	1952 x Ø42 x 30 
05.020.0280.590 Lenkstange Drag Rod 	1700 914 1406 038 34036 01	LF 45	895 x Ø38 x 22 









ST-Artikel ST-Article	Vergleichs-Nr. Comparison No.	passend für to fit to	Details Details
05.020.0280.800 Lenkstange Drag Rod 	1351 737 1311 048 23337 01	XF 95, 95 XF	1000 x Ø36 x 26,5 
 Ersatzteil bzw. Rep.Satz spare part or rep.-kit	05.030.1907.209, Kugelgelenk Ball Joint		
05.020.0280.810 Lenkstange Drag Rod 	1306 333 1351 741 21543 01	XF 95, 95 XF	588 x Ø38 x 26 
 Ersatzteil bzw. Rep.Satz spare part or rep.-kit	05.030.0907.019, Kugelgelenk Ball Joint		
05.020.0280.820 Lenkstange Drag Rod 	1451 118 31937 01	CF 75, CF 85, XF 105, XF 95, 85	860 x Ø38 x 30 
 Ersatzteil bzw. Rep.Satz spare part or rep.-kit	05.030.0907.130, Kugelgelenk Ball Joint		
05.020.0280.830 Lenkstange Drag Rod 	1451 119 26828 01	CF 75, CF 85, XF 105, XF 95	590 x Ø38 x 30 
 Ersatzteil bzw. Rep.Satz spare part or rep.-kit	05.030.0907.019, Kugelgelenk Ball Joint		
	05.030.0907.029, Kugelgelenk Ball Joint		



ST-Artikel ST-Article	Vergleichs-Nr. Comparison No.	passend für to fit to	Details Details
05.020.0280.840 Lenkstange Drag Rod 	1395 999 26832 01	XF 105, XF 95	1952 x Ø42 x 30 
05.030.0275.720 Kugelgelenk Ball Joint 	1399 725 648 637 20565 01	CF 75, CF 85, XF 105, XF 95, 75 CF, 85, 95 XF	80 x 30 / M22 x 1,5 
05.030.0280.030 Kugelgelenk Ball Joint 	067 303 0067 303 11607 01	65 CF, 75, 75 CF, 85, 85 CF, 95	140 x 30 / M48 x 1,5 
 Komplementärteil complemen- tary part	05.030.0280.040, Kugelgelenk Ball Joint		
05.030.0280.040 Kugelgelenk Ball Joint 	067 389 0067 389 11608 01	65 CF, 75, 75 CF, 85, 85 CF, 95	140 x 30 / M48 x 1,5 
 Komplementärteil complemen- tary part	05.030.0280.030, Kugelgelenk Ball Joint		

ST-Artikel ST-Article	Vergleichs-Nr. Comparison No.	passend für to fit to	Details Details
05.030.0280.110 Kugelgelenk Ball Joint 	ACU 9240 19568 01	45	178 x 22 / M28 x 1,5 
 Komplementärteil complemen- tary part	05.030.0280.120, Kugelgelenk Ball Joint		
05.030.0280.111 Kugelgelenk Ball Joint 	1603 788 1604 105 34310 01	CF 75, CF 85, XF 105	120 x 30 / M24 x 1,5 
05.030.0280.112 Kugelgelenk Ball Joint 	1299 555 22536 01	XF 95, 75 CF	90 x 26 / M22 x 1,5 
05.030.0280.113 Kugelgelenk Ball Joint 	1344 684 20605 01	XF 95, 75 CF, 95 XF	115 x 26 / M24 x 1,5 
 Ersatzteil bzw. Rep.Satz spare part or rep.-kit	05.020.0280.430, Lenkstange Drag Rod 05.020.0280.470, Lenkstange Drag Rod		

ST-Artikel ST-Article	Vergleichs-Nr. Comparison No.	passend für to fit to	Details Details
05.030.0280.120 Kugelgelenk Ball Joint	ACU 9239 ACU 9232 19567 01	45	178 x 22 / M28 x 1,5
			
 Komplementärteil complemen- tary part	05.030.0280.110, Kugelgelenk Ball Joint		
05.030.0280.160 Kugelgelenk Ball Joint	1399 724 19783 01	CF 75, CF 85, XF 105, XF 95, 85	95 x 30 / M22 x 1,5
			
05.030.0280.180 Kugelgelenk Ball Joint	1689 604 AMPA 346 11721 01	LF 45	115 x 26 / M28 x 1,5
			
 Komplementärteil complemen- tary part	05.030.0280.190, Kugelgelenk Ball Joint		
05.030.0280.190 Kugelgelenk Ball Joint	1689 605 AMPA 345 19821 01	LF 45	115 x 26 / M28 x 1,5
			
 Komplementärteil complemen- tary part	05.030.0280.180, Kugelgelenk Ball Joint		

ST-Artikel ST-Article	Vergleichs-Nr. Comparison No.	passend für to fit to	Details Details
05.030.0280.210 Kugelgelenk Ball Joint 	1361 618 223 712 18461 01 31708 01	95	85 x 38 / M26 x 1,5 
05.030.0280.220 Kugelgelenk Ball Joint 	1389 190 23763 01	CF 65, CF 75, CF 85, 65 CF, 75 CF, 85 CF, 95 XF	150 x 26 / M30 x 1,5 
 Ersatzteil bzw. Rep.Satz spare part or rep.-kit	05.010.0994.530, Spurstange Tie Rod		
05.030.0280.280 Kugelgelenk Ball Joint 	1315 878 22535 01	85 CF, 95 XF	120 x 30 / M30 x 1,5 
05.030.0280.300 Kugelgelenk Ball Joint 	1401 942 AFRA 635	LF 45	120 x 22 / M30 x 1,5 
 Komplementärteil complementary part	05.030.0280.500, Kugelgelenk Ball Joint		

ST-Artikel ST-Article	Vergleichs-Nr. Comparison No.	passend für to fit to	Details Details
05.030.0280.360 Kugelgelenk Ball Joint 	1604 248	LF 45	148 x 26 / M28 x 1,5 
 Komplementärteil complemen- tary part	05.030.0280.370, Kugelgelenk Ball Joint		
05.030.0280.370 Kugelgelenk Ball Joint 	1604 247	LF 45	148 x 26 / M28 x 1,5 
 Komplementärteil complemen- tary part	05.030.0280.360, Kugelgelenk Ball Joint		
05.030.0280.500 Kugelgelenk Ball Joint 	1401 944	LF 45	120 x 22 / M30 x 1,5 
 Komplementärteil complemen- tary part	05.030.0280.300, Kugelgelenk Ball Joint		

ST-Artikel ST-Article	Vergleichs-Nr. Comparison No.	passend für to fit to	Details Details
05.030.0907.019 Kugelgelenk Ball Joint	1611 088 1329 134	CF 65, CF 75, CF 85, XF 105, XF 95, 85 CF, 95 XF	125 x 30 / M30 x 1,5
	11492 03		
	11492 02		
 Ersatzteil bzw. Rep.Satz spare part or rep.-kit	05.010.0280.900, Spurstange Tie Rod		
	05.010.0803.630, Spurstange Tie Rod		
	05.010.0994.510, Spurstange Tie Rod		
	05.010.1913.460, Spurstange Tie Rod		
	05.010.4007.067, Spurstange Tie Rod		
	05.010.4007.068, Spurstange Tie Rod		
	05.010.4256.320, Spurstange Tie Rod		
	05.010.4256.330, Spurstange Tie Rod		
	05.010.4256.350, Spurstange Tie Rod		
	05.020.0280.820, Lenkstange Drag Rod		
05.020.0280.830, Lenkstange Drag Rod			
05.020.0994.110, Lenkstange Drag Rod			
05.020.0994.120, Lenkstange Drag Rod			
05.020.0994.160, Lenkstange Drag Rod			
05.020.0994.260, Lenkstange Drag Rod			
05.020.0994.280, Lenkstange Drag Rod			
Komplementärteil complementary part	05.030.0907.029, Kugelgelenk Ball Joint		

05.030.0907.029

Kugelgelenk
Ball Joint



1603 789

1618 048

11505 03

11505 02

11389 01

CF 65, CF 75, CF 85, F 2100,
F 2300, F 2500, F 2700, F 2800,
F 2900, F 3200, F 3300, F 3600,
XF 105, XF 95, 65, 65 CF, 75,
75 CF, 85 CF, 95, 95 XF

125 x 30 / M30 x 1,5



Ersatzteil bzw. Rep.Satz | spare
part or rep.-kit

05.010.0280.900, Spurstange | Tie Rod
05.010.0803.630, Spurstange | Tie Rod
05.010.0994.510, Spurstange | Tie Rod
05.010.0994.550, Spurstange | Tie Rod
05.010.1913.460, Spurstange | Tie Rod
05.010.1913.510, Spurstange | Tie Rod
05.010.4007.067, Spurstange | Tie Rod
05.010.4007.068, Spurstange | Tie Rod
05.010.4256.320, Spurstange | Tie Rod
05.010.4256.330, Spurstange | Tie Rod
05.010.4256.350, Spurstange | Tie Rod
05.020.0280.390, Lenkstange | Drag Rod
05.020.0280.830, Lenkstange | Drag Rod
05.020.0803.760, Lenkstange | Drag Rod
05.020.0803.770, Lenkstange | Drag Rod
05.020.0803.780, Lenkstange | Drag Rod
05.020.0994.110, Lenkstange | Drag Rod
05.020.0994.120, Lenkstange | Drag Rod
05.020.0994.160, Lenkstange | Drag Rod
05.020.0994.170, Lenkstange | Drag Rod
05.020.0994.190, Lenkstange | Drag Rod
05.020.0994.260, Lenkstange | Drag Rod
05.020.0994.280, Lenkstange | Drag Rod
05.020.1913.250, Lenkstange | Drag Rod
05.020.1913.290, Lenkstange | Drag Rod
05.020.1913.330, Lenkstange | Drag Rod
05.020.1913.360, Lenkstange | Drag Rod
05.020.1913.370, Lenkstange | Drag Rod
05.020.1913.380, Lenkstange | Drag Rod
05.020.1913.410, Lenkstange | Drag Rod
05.020.4256.370, Lenkstange | Drag Rod

Komplementärteil | complemen-
tary part

05.030.0907.019, Kugelgelenk | Ball Joint

05.030.0907.130

Kugelgelenk
Ball Joint



1685 552

25353 01

CF 65, CF 75, CF 85, F 1600,
F 1700, F 1900, F 2000, F 2100,
65 CF, 75 CF, 85 CF, 95, 95 XF

140 x 30 / M30 x 1,5



Ersatzteil bzw. Rep.Satz | spare
part or rep.-kit

05.010.0280.380, Spurstange | Tie Rod
05.010.0994.520, Spurstange | Tie Rod
05.010.3001.910, Spurstange | Tie Rod
05.020.0280.820, Lenkstange | Drag Rod
05.020.0994.140, Lenkstange | Drag Rod
05.020.0994.270, Lenkstange | Drag Rod

ST-Artikel ST-Article	Vergleichs-Nr. Comparison No.	passend für to fit to	Details Details
05.030.0907.200 Kugelgelenk Ball Joint 	1271 126 30756 01	LF 45	86 x 38 / M30 x 1,5 
05.030.0993.860 Kugelgelenk Ball Joint 	1785 340 27853 01	CF 75, CF 85, XF 105	145 x 30 / M30 x 1,5 
 Ersatzteil bzw. Rep.Satz spare part or rep.-kit	05.010.0280.910, Spurstange Tie Rod 05.010.3001.920, Spurstange Tie Rod		
05.030.1907.120 Kugelgelenk Ball Joint 	607 453 110 197 11378 01	F 1700, F 1900	101 x 22 / M28 x 1,5 
 Ersatzteil bzw. Rep.Satz spare part or rep.-kit Komplementärteil complementary part	05.010.1913.480, Spurstange Tie Rod 05.020.0994.250, Lenkstange Drag Rod 05.030.1907.160, Kugelgelenk Ball Joint		
05.030.1907.160 Kugelgelenk Ball Joint 	1743 594 1373 137 11379 01	F 1700, F 1900	101 x 22 / M28 xx 1,5 
 Komplementärteil complementary part	05.030.1907.120, Kugelgelenk Ball Joint		

ST-Artikel ST-Article	Vergleichs-Nr. Comparison No.	passend für to fit to	Details Details
05.030.1907.180 Kugelgelenk Ball Joint 	608 530 11376 02 11376 01 19667 01	75 CF, 85 CF, 95, 95 XF	95 x 20 / M24 x 1,5 
 Komplementärteil complemen- tary part	05.030.1907.190, Kugelgelenk Ball Joint		
05.030.1907.209 Kugelgelenk Ball Joint 	1331 925 1229 944 11402 01 25718 01 24570 01	CF 65, CF 75, CF 85, LF 45, LF 55, XF 105, XF 95, 65, 65 CF, 75, 75 CF, 85, 85 CF, 95, 95 XF	120 x 26 / M30 x 1,5 
 Ersatzteil bzw. Rep.Satz spare part or rep.-kit	05.010.1913.500, Spurstange Tie Rod 05.020.0280.800, Lenkstange Drag Rod 05.020.0994.560, Lenkstange Drag Rod 05.020.0994.570, Lenkstange Drag Rod 05.020.1913.280, Lenkstange Drag Rod 05.020.4007.084, Lenkstange Drag Rod 05.020.4007.085, Lenkstange Drag Rod		
Komplementärteil complemen- tary part	05.030.1907.549, Kugelgelenk Ball Joint		
05.030.1907.549 Kugelgelenk Ball Joint 	1338 714 1315 447 11403 01 11728 01 19675 01	CF 75, CF 85, XF 105, XF 95, 65 CF, 75, 75 CF, 85, 85 CF, 95 XF	120 x 26 / M30 x 1,5 
 Komplementärteil complemen- tary part	05.030.1907.209, Kugelgelenk Ball Joint		

ST-Artikel ST-Article	Vergleichs-Nr. Comparison No.	passend für to fit to	Details Details
05.030.1907.980 Kugelgelenk Ball Joint 	1142 173 1326 866 11388 01	F 1600, F 1800	125 x 26 / M30 x 1,5 
05.030.3040.110 Kugelgelenk Ball Joint 	1603 883 21440 01 11393 01	LF 55	150 x 30 / M30 x 1,5 
 Ersatzteil bzw. Rep.Satz spare part or rep.-kit	05.010.4256.360, Spurstange Tie Rod		
05.050.0278.100 Hydraulikpumpe, Lenkung Hydraulic Pump, Steering 	1375 507 542 0433 10	CF 75, CF 85, 75 CF, 85 CF	M26x1,5 / M18x1,5 
05.050.0278.110 Hydraulikpumpe, Lenkung Hydraulic Pump, Steering 	1291 227 367 352 7672.955.287 542 0014 10	XF 95, 75 CF, 85 CF, 95 XF	M26x1,5 / M16x1,5 



passend für | to fit to DAF

ST-Artikel
ST-Article

Vergleichs-Nr.
Comparison No.

passend für
to fit to

Details
Details

05.050.0278.130

Hydraulikpumpe, Lenkung
Hydraulic Pump, Steering



1797 644
1901 570

8695.671.117

CF 85, XF 105

M26x1,5 / M18x1,5













passend für
to fit to

Iveco

LKW
Truck

ST-Artikel ST-Article	Vergleichs-Nr. Comparison No.	passend für to fit to	Details Details
05.010.0803.070 Spurstange Tie Rod 	5 0030 7556 9840 2553 21385 01	EuroCargo I, EuroCargo II	1490 x Ø38 x 26 
 Ersatzteil bzw. Rep.Satz spare part or rep.-kit	05.030.1907.209, Kugelgelenk Ball Joint 05.030.1907.549, Kugelgelenk Ball Joint		
05.010.0803.071 Spurstange Tie Rod 	4100 5460 4100 5309 25318 01	EuroCargo I, EuroTrakker, Trakker	1577 x Ø48 x 30 
 Ersatzteil bzw. Rep.Satz spare part or rep.-kit	05.030.0907.019, Kugelgelenk Ball Joint 05.030.0907.029, Kugelgelenk Ball Joint		
05.010.0803.072 Spurstange Tie Rod 	4129 6162 35513 01	Stralis I	1315 x Ø50 x 30 
 Ersatzteil bzw. Rep.Satz spare part or rep.-kit	05.030.0907.130, Kugelgelenk Ball Joint		
05.010.0803.074 Spurstange Tie Rod 	5 0403 4521 30078 01	EuroCargo I, EuroCargo II	1570 x Ø42 x 30 
 Ersatzteil bzw. Rep.Satz spare part or rep.-kit	05.030.0907.019, Kugelgelenk Ball Joint 05.030.0907.029, Kugelgelenk Ball Joint		

ST-Artikel ST-Article	Vergleichs-Nr. Comparison No.	passend für to fit to	Details Details
05.010.0803.180 Spurstange Tie Rod 	4100 5451 4100 5450 21285 01	EuroStar, EuroTech MH, Euro- Tech MP, EuroTrakker, Stralis I, Stralis II, Trakker	1620 x Ø48 x 30 
 Ersatzteil bzw. Rep.Satz spare part or rep.-kit	05.030.0907.019, Kugelgelenk Ball Joint 05.030.0907.029, Kugelgelenk Ball Joint		
05.010.0803.390 Spurstange Tie Rod 	0485 4871 25175 01	EuroCargo I, EuroCargo II, EuroFire	1584 x Ø42 x 26 
05.010.0803.540 Spurstange Tie Rod 	9846 9650 9844 9025 20423 01	EuroCargo I, EuroCargo II	878 x Ø36 x 30 
 Ersatzteil bzw. Rep.Satz spare part or rep.-kit	05.030.0907.029, Kugelgelenk Ball Joint		
05.010.0803.550 Spurstange Tie Rod 	4211 8694 4211 8782 23255 01	EuroTrakker, Trakker	1485 x Ø60 x 30 
 Ersatzteil bzw. Rep.Satz spare part or rep.-kit	05.030.0907.029, Kugelgelenk Ball Joint		

ST-Artikel ST-Article	Vergleichs-Nr. Comparison No.	passend für to fit to	Details Details
05.010.0803.630 Spurstange Tie Rod 	4103 2608 4103 3237 27892 01	EuroStar, EuroTech MP, Stralis I, Stralis II	1477 x Ø48 x 30 
 Ersatzteil bzw. Rep.Satz spare part or rep.-kit	05.030.0907.019, Kugelgelenk Ball Joint 05.030.0907.029, Kugelgelenk Ball Joint		
05.020.0803.090 Lenkstange Drag Rod 	9840 2544 9846 7459 19339 01	EuroCargo I, EuroCargo II, EuroFire	822 x Ø40 x 26 
 Ersatzteil bzw. Rep.Satz spare part or rep.-kit	05.030.1907.209, Kugelgelenk Ball Joint		
05.020.0803.300 Lenkstange Drag Rod 	0485 4874 18977 01	EuroCargo I, EuroFire	902 x Ø42 x 26 
05.020.0803.320 Lenkstange Drag Rod 	4100 5463 0813 1582 19621 01	EuroStar, EuroTech MH, Euro- Tech MP, EuroTrakker, Stralis I, Trakker	953 x Ø52 x 30 
 Ersatzteil bzw. Rep.Satz spare part or rep.-kit	05.030.0907.029, Kugelgelenk Ball Joint		

ST-Artikel ST-Article	Vergleichs-Nr. Comparison No.	passend für to fit to	Details Details
05.020.0803.340 Lenkstange Drag Rod 	9844 6354 19989 02	EuroTech MP	900 x Ø50 x 30 
 Ersatzteil bzw. Rep.Satz spare part or rep.-kit	05.030.0907.029, Kugelgelenk Ball Joint		
05.020.0803.400 Lenkstange Drag Rod 	4101 6964 4100 5466 18054 01	EuroTrakker	698 x Ø52 x 30 
 Ersatzteil bzw. Rep.Satz spare part or rep.-kit	05.030.0907.029, Kugelgelenk Ball Joint		
05.020.0803.460 Lenkstange Drag Rod 	4102 8269 26679 01	EuroTrakker, Trakker	887 x Ø52 x 30 
 Ersatzteil bzw. Rep.Satz spare part or rep.-kit	05.030.0907.029, Kugelgelenk Ball Joint		
05.020.0803.470 Lenkstange Drag Rod 	4100 6093 4100 5475 23372 01	EuroTrakker	952 x Ø52 x 30 
 Ersatzteil bzw. Rep.Satz spare part or rep.-kit	05.030.0907.029, Kugelgelenk Ball Joint		

ST-Artikel ST-Article	Vergleichs-Nr. Comparison No.	passend für to fit to	Details Details
05.020.0803.720 Lenkstange Drag Rod 	5 0404 9893 33416 02	EuroCargo I, EuroCargo II, EuroFire	892 x Ø42 x 30 
 Ersatzteil bzw. Rep.Satz spare part or rep.-kit	05.030.0907.029, Kugelgelenk Ball Joint		
05.020.0803.760 Lenkstange Drag Rod 	4101 6961 4101 6960 23377 01	EuroStar, Stralis I	824 x Ø52 x 30 
 Ersatzteil bzw. Rep.Satz spare part or rep.-kit	05.030.0907.029, Kugelgelenk Ball Joint		
05.020.0803.770 Lenkstange Drag Rod 	5 0039 7738 27656 01	EuroStar, Stralis I, Stralis II	959 x Ø52 x 30 
 Ersatzteil bzw. Rep.Satz spare part or rep.-kit	05.030.0907.029, Kugelgelenk Ball Joint		
05.020.0803.780 Lenkstange Drag Rod 	4104 2749 35508 01	Stralis I	1385 x Ø58 x 30 
 Ersatzteil bzw. Rep.Satz spare part or rep.-kit	05.030.0907.029, Kugelgelenk Ball Joint		

ST-Artikel ST-Article	Vergleichs-Nr. Comparison No.	passend für to fit to	Details Details
05.030.0280.180 Kugelgelenk Ball Joint 	468 8941 716 7757 11721 01	Zeta	115 x 26 / M28 x 1,5 
 Komplementärteil complemen- tary part	05.030.0280.190, Kugelgelenk Ball Joint		
05.030.0280.190 Kugelgelenk Ball Joint 	468 8942 858 2333 19821 01	Zeta	115 x 26 / M28 x 1,5 
 Komplementärteil complemen- tary part	05.030.0280.180, Kugelgelenk Ball Joint		
05.030.0280.210 Kugelgelenk Ball Joint 	4253 2294 4210 5474 18461 01 31708 01	EuroTrakker	85 x 38 / M26 x 1,5 
05.030.0803.430 Kugelgelenk Ball Joint 	4253 8047 4253 0316 25073 01	EuroTrakker, P/PA, Trakker	86 x 38 / M30 x 1,5 

ST-Artikel
ST-Article

Vergleichs-Nr.
Comparison No.

passend für
to fit to

Details
Details

05.030.0803.710

Kugelgelenk
Ball Joint



5 0030 9296
5 0034 0769

22806 01

EuroStar, EuroTech MP, Stralis I

139 x 30 / M30 x 1,5



05.030.0907.019

Kugelgelenk
Ball Joint



0483 3830
0480 2444

11492 03
11492 02
11390 01

EuroCargo I, EuroCargo II,
EuroStar, EuroTech MP, EuroTrakker,
Stralis I, TurboStar, TurboTech

125 x 30 / M30 x 1,5



Ersatzteil bzw. Rep.Satz | spare part or rep.-kit

05.010.0280.900, Spurstange | Tie Rod
05.010.0803.630, Spurstange | Tie Rod
05.010.0994.510, Spurstange | Tie Rod
05.010.1913.460, Spurstange | Tie Rod
05.010.4007.067, Spurstange | Tie Rod
05.010.4007.068, Spurstange | Tie Rod
05.010.4256.320, Spurstange | Tie Rod
05.010.4256.330, Spurstange | Tie Rod
05.010.4256.350, Spurstange | Tie Rod
05.020.0280.820, Lenkstange | Drag Rod
05.020.0280.830, Lenkstange | Drag Rod
05.020.0994.110, Lenkstange | Drag Rod
05.020.0994.120, Lenkstange | Drag Rod
05.020.0994.160, Lenkstange | Drag Rod
05.020.0994.260, Lenkstange | Drag Rod
05.020.0994.280, Lenkstange | Drag Rod

Komplementärteil | complementary part

05.030.0907.029, Kugelgelenk | Ball Joint

ST-Artikel ST-Article	Vergleichs-Nr. Comparison No.	passend für to fit to	Details Details
--------------------------	----------------------------------	--------------------------	--------------------

05.030.0907.029

Kugelgelenk
Ball Joint



4253 7936
0483 3829

11505 03
11505 02
11389 01

EuroCargo I, EuroCargo II,
EuroFire, EuroStar, EuroTech MP,
EuroTrakker, Stralis I, TurboStar,
TurboTech

125 x 30 / M30 x 1,5



i Ersatzteil bzw. Rep.Satz | spare part or rep.-kit

- 05.010.0280.900, Spurstange | Tie Rod
- 05.010.0803.630, Spurstange | Tie Rod
- 05.010.0994.510, Spurstange | Tie Rod
- 05.010.0994.550, Spurstange | Tie Rod
- 05.010.1913.460, Spurstange | Tie Rod
- 05.010.1913.510, Spurstange | Tie Rod
- 05.010.4007.067, Spurstange | Tie Rod
- 05.010.4007.068, Spurstange | Tie Rod
- 05.010.4256.320, Spurstange | Tie Rod
- 05.010.4256.330, Spurstange | Tie Rod
- 05.010.4256.350, Spurstange | Tie Rod
- 05.020.0280.390, Lenkstange | Drag Rod
- 05.020.0280.830, Lenkstange | Drag Rod
- 05.020.0803.760, Lenkstange | Drag Rod
- 05.020.0803.770, Lenkstange | Drag Rod
- 05.020.0803.780, Lenkstange | Drag Rod
- 05.020.0994.110, Lenkstange | Drag Rod
- 05.020.0994.120, Lenkstange | Drag Rod
- 05.020.0994.160, Lenkstange | Drag Rod
- 05.020.0994.170, Lenkstange | Drag Rod
- 05.020.0994.190, Lenkstange | Drag Rod
- 05.020.0994.260, Lenkstange | Drag Rod
- 05.020.0994.280, Lenkstange | Drag Rod
- 05.020.1913.250, Lenkstange | Drag Rod
- 05.020.1913.290, Lenkstange | Drag Rod
- 05.020.1913.330, Lenkstange | Drag Rod
- 05.020.1913.360, Lenkstange | Drag Rod
- 05.020.1913.370, Lenkstange | Drag Rod
- 05.020.1913.380, Lenkstange | Drag Rod
- 05.020.1913.410, Lenkstange | Drag Rod
- 05.020.4256.370, Lenkstange | Drag Rod

Komplementärteil | complementary part

05.030.0907.019, Kugelgelenk | Ball Joint

05.030.0907.030

Kugelgelenk
Ball Joint



9319 2809
25165 01

EuroStar, EuroTech MP

80 x 30 / M30 x 1,5



ST-Artikel
ST-Article

Vergleichs-Nr.
Comparison No.

passend für
to fit to

Details
Details

05.030.0907.130

Kugelgelenk
Ball Joint



4253 8384

25353 01

EuroCargo I, EuroCargo II,
EuroTech MH, EuroTech MP, EuroTech MT, EuroTrakker, Stralis I

140 x 30 / M30 x 1,5



Ersatzteil bzw. Rep.Satz | spare part or rep.-kit

05.010.0280.380, Spurstange | Tie Rod
05.010.0994.520, Spurstange | Tie Rod
05.010.3001.910, Spurstange | Tie Rod
05.020.0280.820, Lenkstange | Drag Rod
05.020.0994.140, Lenkstange | Drag Rod
05.020.0994.270, Lenkstange | Drag Rod

05.030.0993.870

Kugelgelenk
Ball Joint



4253 3102

4253 3101

EuroStar, EuroTech MH, EuroTech MP, Stralis I

80 x 30 / M26 x 1,5



05.030.1907.120

Kugelgelenk
Ball Joint



11378 01

MK, P/PA, Zeta

101 x 22 / M28 x 1,5



Ersatzteil bzw. Rep.Satz | spare part or rep.-kit
Komplementärteil | complementary part

05.010.1913.480, Spurstange | Tie Rod
05.020.0994.250, Lenkstange | Drag Rod
05.030.1907.160, Kugelgelenk | Ball Joint

ST-Artikel ST-Article	Vergleichs-Nr. Comparison No.	passend für to fit to	Details Details
05.030.1907.160 Kugelgelenk Ball Joint 	4248 4887 296 9507 11379 01	MK, P/PA, Zeta	101 x 22 / M28 xx 1,5 
 Komplementärteil complemen- tary part	05.030.1907.120, Kugelgelenk Ball Joint		
05.030.1907.180 Kugelgelenk Ball Joint 	4249 1937 4248 0024 11376 02 11376 01 19667 01	MK	95 x 20 / M24 x 1,5 
 Komplementärteil complemen- tary part	05.030.1907.190, Kugelgelenk Ball Joint		
05.030.1907.190 Kugelgelenk Ball Joint 	0819 3649 4253 2543 11377 03 11377 01	Iveco	95 x 20 / M24 x 1,5 
 Komplementärteil complemen- tary part	05.030.1907.180, Kugelgelenk Ball Joint		

05.030.1907.209

Kugelgelenk
Ball Joint



Ersatzteil bzw. Rep.Satz | spare part or rep.-kit

Komplementärteil | complementary part

0483 3827
0812 2754

11402 01
25718 01
24570 01

05.010.1913.500, Spurstange | Tie Rod
05.020.0280.800, Lenkstange | Drag Rod
05.020.0994.560, Lenkstange | Drag Rod
05.020.0994.570, Lenkstange | Drag Rod
05.020.1913.280, Lenkstange | Drag Rod
05.020.4007.084, Lenkstange | Drag Rod
05.020.4007.085, Lenkstange | Drag Rod

05.030.1907.549, Kugelgelenk | Ball Joint

EuroCargo I, EuroFire

120 x 26 / M30 x 1,5



05.030.1907.410

Kugelgelenk
Ball Joint



9319 4627
0855 8524

11381 01

Zeta

106 x 22 / M24 x 1,5



05.030.1907.549

Kugelgelenk
Ball Joint



Komplementärteil | complementary part

0483 3828
0298 4511

11403 01
11728 01
19675 01

05.030.1907.209, Kugelgelenk | Ball Joint

EuroCargo I, EuroFire

120 x 26 / M30 x 1,5



ST-Artikel ST-Article	Vergleichs-Nr. Comparison No.	passend für to fit to	Details Details
05.030.1907.980 Kugelgelenk Ball Joint 	0298 0875 11388 01	MK	125 x 26 / M30 x 1,5 
05.030.1980.860 Kugelgelenk Ball Joint 	0855 8527 4248 7165 11380 01 19674 01 11380 02	Zeta	106 x 22 / M24 x 1,5 
 Komplementärteil complemen- tary part	05.030.1907.410, Kugelgelenk Ball Joint		
05.030.1980.970 Kugelgelenk Ball Joint 	0468 8948	TurboStar, TurboTech	125 x 30 / M38 x 1,5 
05.050.0884.000 Hydraulikpumpe, Lenkung Hydraulic Pump, Steering 	4121 1223 8695.955.116	EuroStar, EuroTech MH, Euro- Tech MP, EuroTrakker, Stralis I, Stralis II, Trakker	M26x1,5 / M18x1,5 

ST-Artikel
ST-Article

Vergleichs-Nr.
Comparison No.

passend für
to fit to

Details
Details

05.050.0884.010

Hydraulikpumpe, Lenkung
Hydraulic Pump, Steering

483 1152

7673.955.294

EuroStar, EuroTech MP, Euro-
Trakker











M26x1,5 / M18x1,5











passend für
to fit to

MAN













LKW
Truck

ST-Artikel ST-Article	Vergleichs-Nr. Comparison No.	passend für to fit to	Details Details
05.010.0993.201 Spurstange Tie Rod 	81.46711.6892 81.46711.6891 31773 01	TGL	1666 x Ø36 x 22 
 Ersatzteil bzw. Rep.Satz spare part or rep.-kit	05.030.1907.120, Kugelgelenk Ball Joint 05.030.1907.160, Kugelgelenk Ball Joint		
05.010.0993.202 Spurstange Tie Rod 	81.46711.6894 81.46711.6893 31882 01	TGL, TGM	1632 x Ø38 x 22 
 Ersatzteil bzw. Rep.Satz spare part or rep.-kit	05.030.1907.120, Kugelgelenk Ball Joint 05.030.1907.160, Kugelgelenk Ball Joint		
05.010.0993.204 Spurstange Tie Rod 	81.46711.6579 81.46711.6720 25276 01	F 2000, F 90, M 2000 L, TGA, TGS, TGX	1530 x Ø50 x 30 
05.010.0993.210 Spurstange Tie Rod 	81.46711.6820 81.46711.6725 11768 01	E 2000, F 2000, F 90, M 2000 L, M 2000 M, TGA, TGS, TGX	1652 x Ø50 x 30 
 Ersatzteil bzw. Rep.Satz spare part or rep.-kit	05.030.0907.019, Kugelgelenk Ball Joint 05.030.0907.029, Kugelgelenk Ball Joint		

ST-Artikel ST-Article	Vergleichs-Nr. Comparison No.	passend für to fit to	Details Details
05.010.0993.220 Spurstange Tie Rod 	81.46711.6736 81.46711.6747 11770 01	E 2000, F 2000, F 90, L 2000, M 2000 L, M 2000 M, TGA, TGM, TGS	1588 x Ø52 x 30 
 Ersatzteil bzw. Rep.Satz spare part or rep.-kit	05.030.0907.029, Kugelgelenk Ball Joint		
05.010.0993.260 Spurstange Tie Rod 	81.46710.6393 81.46710.6388 21282 01	F 90, M 90	1585 x Ø50 x 26 
 Ersatzteil bzw. Rep.Satz spare part or rep.-kit	05.030.1907.209, Kugelgelenk Ball Joint 05.030.1907.549, Kugelgelenk Ball Joint		
05.010.0993.270 Spurstange Tie Rod 	81.46711.6724 81.46710.6904 19995 01	E 2000, F 2000, F 90, M 2000 L, M 2000 M, M 90	1628 x Ø50 x 30 
 Ersatzteil bzw. Rep.Satz spare part or rep.-kit	05.030.0907.029, Kugelgelenk Ball Joint		
05.010.0993.330 Spurstange Tie Rod 	81.46711.6921 81.46711.6860 25395 01	M 2000 L, M 2000 M, TGA, TGM, TGS, TGX	1680 x Ø52 x 30 
 Ersatzteil bzw. Rep.Satz spare part or rep.-kit	05.030.3040.110, Kugelgelenk Ball Joint		

ST-Artikel ST-Article	Vergleichs-Nr. Comparison No.	passend für to fit to	Details Details
05.010.0993.400 Spurstange Tie Rod 	81.46711.6726 81.46710.6994 23305 01	E 2000, F 2000	1664 x Ø50 x 30 
<i>i</i> Ersatzteil bzw. Rep.Satz spare part or rep.-kit	05.030.0907.029, Kugelgelenk Ball Joint		
05.010.0993.410 Spurstange Tie Rod 	81.46711.6728 81.46710.6866 20889 01	L 2000	1670 x Ø30 x 20 
<i>i</i> Ersatzteil bzw. Rep.Satz spare part or rep.-kit	05.030.1907.180, Kugelgelenk Ball Joint 05.030.1907.190, Kugelgelenk Ball Joint		
05.010.0993.450 Spurstange Tie Rod 	81.46711.6729 81.46711.6719 21014 01	L 2000, M 2000 L	1630 x Ø35 x 22 
<i>i</i> Ersatzteil bzw. Rep.Satz spare part or rep.-kit	05.030.1907.120, Kugelgelenk Ball Joint 05.030.1907.160, Kugelgelenk Ball Joint		
05.010.0993.700 Spurstange Tie Rod 	81.46710.6316 81.46710.6315 23275 01	M 2000 L, M 90	1545 x Ø38 x 26 
<i>i</i> Ersatzteil bzw. Rep.Satz spare part or rep.-kit	05.030.1907.209, Kugelgelenk Ball Joint 05.030.1907.549, Kugelgelenk Ball Joint		

ST-Artikel ST-Article	Vergleichs-Nr. Comparison No.	passend für to fit to	Details Details
05.010.0993.910 Spurstange Tie Rod 	81.46711.6711 81.46710.6934 23307 01	M 2000 L, M 2000 M	1650 x Ø50 x 26 
<i>i</i>	Ersatzteil bzw. Rep.Satz spare part or rep.-kit	05.030.0280.220, Kugelgelenk Ball Joint	
05.010.0993.920 Spurstange Tie Rod 	81.46711.6714 81.46710.6966 23270 01	F 2000	1625 x Ø50 x 30 
<i>i</i>	Ersatzteil bzw. Rep.Satz spare part or rep.-kit	05.030.0993.860, Kugelgelenk Ball Joint	
05.010.0994.180 Spurstange Tie Rod 	81.46711.6743 81.46711.6744 28766 01	L 2000, M 2000 L, M 2000 M, M 90, TGM	1450 x Ø50 x 26 
<i>i</i>	Ersatzteil bzw. Rep.Satz spare part or rep.-kit	05.030.0907.130, Kugelgelenk Ball Joint	
05.010.0994.510 Spurstange Tie Rod 	81.46711.6933 81.46711.6934 35809 01	TGA, TGS, TGX	1680 x Ø42 x 30 
<i>i</i>	Ersatzteil bzw. Rep.Satz spare part or rep.-kit	05.030.0907.019, Kugelgelenk Ball Joint 05.030.0907.029, Kugelgelenk Ball Joint	

ST-Artikel ST-Article	Vergleichs-Nr. Comparison No.	passend für to fit to	Details Details
05.010.0994.520 Spurstange Tie Rod 	81.46711.6801 81.46711.6864 34594 01	TGA, TGS, TGX	1392 x Ø60 x 30 
	Ersatzteil bzw. Rep.Satz spare part or rep.-kit	05.030.0907.130, Kugelgelenk Ball Joint	
05.010.0994.530 Spurstange Tie Rod 	81.46711.6818 81.46711.6819 34595 01	TGM	1680 x Ø50 x 26 
	Ersatzteil bzw. Rep.Satz spare part or rep.-kit	05.030.0280.220, Kugelgelenk Ball Joint	
05.010.0994.550 Spurstange Tie Rod 	81.46710.6918 81.46711.6740 23265 01	E 2000, F 2000, F 90	1585 x Ø60 x 30 
	Ersatzteil bzw. Rep.Satz spare part or rep.-kit	05.030.0907.029, Kugelgelenk Ball Joint	
05.020.0907.050 Lenkstange Drag Rod 	81.46611.6216 81.46610.6722 11766 01	E 2000, F 2000, F 90	1035 x Ø48 x 30 
	Ersatzteil bzw. Rep.Satz spare part or rep.-kit	05.030.0907.029, Kugelgelenk Ball Joint	

ST-Artikel ST-Article	Vergleichs-Nr. Comparison No.	passend für to fit to	Details Details
05.020.0907.210 Lenkstange Drag Rod 	82.46610.6184 82.46610.6185 28331 01	TGA, TGS	993 x Ø40 x 30 
 Ersatzteil bzw. Rep.Satz spare part or rep.-kit	05.030.0907.019, Kugelgelenk Ball Joint 05.030.0907.029, Kugelgelenk Ball Joint		
05.020.0907.220 Lenkstange Drag Rod 	81.46611.6161 81.46611.6162 28328 01	TGA, TGS	1800 x Ø62 x 30 
05.020.0907.260 Lenkstange Drag Rod 	81.46710.6434 81.46710.6435 25099 02 25099 01	M 90	900 x Ø40 x 26 
 Ersatzteil bzw. Rep.Satz spare part or rep.-kit	05.030.1907.209, Kugelgelenk Ball Joint		
05.020.0907.280 Lenkstange Drag Rod 	81.46611.6197 81.46611.6198 30592 01 25213 01 25717 01	TGA, TGS, TGX	995 x Ø52 x 30 
 Ersatzteil bzw. Rep.Satz spare part or rep.-kit	05.030.0907.029, Kugelgelenk Ball Joint		

ST-Artikel ST-Article	Vergleichs-Nr. Comparison No.	passend für to fit to	Details Details
05.020.0993.241 Lenkstange Drag Rod 	85.46610.6162 31895 01	TGL	820 x Ø38 x 22 
 Ersatzteil bzw. Rep.Satz spare part or rep.-kit	05.030.1907.120, Kugelgelenk Ball Joint		
05.020.0993.242 Lenkstange Drag Rod 	85.46610.6163 34591 01	TGM	882 x Ø42 x 30 
 Ersatzteil bzw. Rep.Satz spare part or rep.-kit	05.030.0907.029, Kugelgelenk Ball Joint		
05.020.0993.243 Lenkstange Drag Rod 	81.46611.6156 81.46611.6155 34592 01	TGA, TGS	1796 x Ø62 x 30 
05.020.0993.250 Lenkstange Drag Rod 	81.46610.6305 81.46610.6301 17802 01	G, G 90	780 x Ø35 x 22 
 Ersatzteil bzw. Rep.Satz spare part or rep.-kit	05.030.1907.120, Kugelgelenk Ball Joint		

ST-Artikel ST-Article	Vergleichs-Nr. Comparison No.	passend für to fit to	Details Details
05.020.0993.280 Lenkstange Drag Rod 	85.46610.6102 85.46610.6030 19607 01	L 2000	820 x Ø32 x 20 
 Ersatzteil bzw. Rep.Satz spare part or rep.-kit	05.030.1907.180, Kugelgelenk Ball Joint		
05.020.0993.340 Lenkstange Drag Rod 	81.46611.6199 81.46611.6200 30593 01	TGA, TGS, TGX	970 x Ø52 x 30 
 Ersatzteil bzw. Rep.Satz spare part or rep.-kit	05.030.0907.029, Kugelgelenk Ball Joint		
05.020.0993.380 Lenkstange Drag Rod 	81.46610.6779 81.46610.6782 20592 01	E 2000, F 2000	1045 x Ø48 x 30 
 Ersatzteil bzw. Rep.Satz spare part or rep.-kit	05.030.0906.610, Kugelgelenk Ball Joint		
05.020.0993.420 Lenkstange Drag Rod 	81.46610.6656 81.46610.6659 19606 01	F 90	1055 x Ø40 x 30 
 Ersatzteil bzw. Rep.Satz spare part or rep.-kit	05.030.0907.029, Kugelgelenk Ball Joint		

ST-Artikel ST-Article	Vergleichs-Nr. Comparison No.	passend für to fit to	Details Details
05.020.0993.430 Lenkstange Drag Rod 	85.46610.6104 81.46610.6754 20991 01	L 2000	829 x Ø38 x 22 
 Ersatzteil bzw. Rep.Satz spare part or rep.-kit	05.030.1907.120, Kugelgelenk Ball Joint		
05.020.0993.440 Lenkstange Drag Rod 	81.46710.6442 81.46710.6443 21408 01	M 90	1000 x Ø42 x 30 
 Ersatzteil bzw. Rep.Satz spare part or rep.-kit	05.030.0907.029, Kugelgelenk Ball Joint		
05.020.0993.460 Lenkstange Drag Rod 	81.46611.6004 81.46611.6005 26916 01	E 2000, F 2000	1063 x Ø42 x 30 
 Ersatzteil bzw. Rep.Satz spare part or rep.-kit	05.030.0907.029, Kugelgelenk Ball Joint		
05.020.0993.470 Lenkstange Drag Rod 	81.46710.6418 20396 01	F 90	1795 x Ø50 x 30 

ST-Artikel ST-Article	Vergleichs-Nr. Comparison No.	passend für to fit to	Details Details
05.020.0993.480 Lenkstange Drag Rod 	81.46710.6436 81.46710.6437 25100 02	M 90	955 x Ø40 x 26 
 Ersatzteil bzw. Rep.Satz spare part or rep.-kit	05.030.1907.209, Kugelgelenk Ball Joint		
05.020.0993.620 Lenkstange Drag Rod 	85.46610.6143 85.46610.6107 23464 02	M 2000 L	860 x Ø38 x 30 
 Ersatzteil bzw. Rep.Satz spare part or rep.-kit	05.030.0907.029, Kugelgelenk Ball Joint		
05.020.0993.650 Lenkstange Drag Rod 	85.46610.6142 85.46610.6112 23417 01	M 2000 L, TGL	860 x Ø38 x 26 
 Ersatzteil bzw. Rep.Satz spare part or rep.-kit	05.030.1907.209, Kugelgelenk Ball Joint		
05.020.0993.660 Lenkstange Drag Rod 	85.46610.6140 85.46610.6021 23405 01	L 2000, M 2000 L, TGL	840 x Ø38 x 22 
 Ersatzteil bzw. Rep.Satz spare part or rep.-kit	05.030.1907.120, Kugelgelenk Ball Joint		

ST-Artikel ST-Article	Vergleichs-Nr. Comparison No.	passend für to fit to	Details Details
05.020.0993.670 Lenkstange Drag Rod 	81.46610.6304 81.46610.6329 18376 01	G 90	785 x Ø30 x 22 
<i>i</i> Ersatzteil bzw. Rep.Satz spare part or rep.-kit	05.030.1907.180, Kugelgelenk Ball Joint		
05.020.0993.680 Lenkstange Drag Rod 	81.46611.6201 81.46611.6203 30585 01	TGA, TGS	1021 x Ø52 x 30 
<i>i</i> Ersatzteil bzw. Rep.Satz spare part or rep.-kit	05.030.0907.130, Kugelgelenk Ball Joint		
05.020.0993.690 Lenkstange Drag Rod 	81.46710.6438 81.46710.6439 18919 01	M 90	1000 x Ø40 x 26 
<i>i</i> Ersatzteil bzw. Rep.Satz spare part or rep.-kit	05.030.1907.209, Kugelgelenk Ball Joint		
05.020.0993.750 Lenkstange Drag Rod 	85.46610.6152 85.46610.6018 24380 01	M 2000 M	980 x Ø42 x 30 
<i>i</i> Ersatzteil bzw. Rep.Satz spare part or rep.-kit	05.030.0907.029, Kugelgelenk Ball Joint		

ST-Artikel ST-Article	Vergleichs-Nr. Comparison No.	passend für to fit to	Details Details
05.020.0993.760 Lenkstange Drag Rod 	81.46611.6013 81.46610.6691 24123 01	F 2000, F 90	1060 x Ø52 x 30 
 Ersatzteil bzw. Rep.Satz spare part or rep.-kit	05.030.0907.029, Kugelgelenk Ball Joint		
05.020.0993.770 Lenkstange Drag Rod 	81.46611.6019 81.46610.6374 22058 01	E 2000, F 2000	1050 x Ø42 x 30 
 Ersatzteil bzw. Rep.Satz spare part or rep.-kit	05.030.0907.019, Kugelgelenk Ball Joint 05.030.0907.029, Kugelgelenk Ball Joint		
05.020.0993.790 Lenkstange Drag Rod 	85.46610.6156 28330 01	CLA, L 2000, M 2000 L	882 x Ø38 x 30 
 Ersatzteil bzw. Rep.Satz spare part or rep.-kit	05.030.0907.029, Kugelgelenk Ball Joint		
05.020.0993.880 Lenkstange Drag Rod 	85.46610.6150 85.46610.6019 23407 01	M 2000 M	910 x Ø40 x 26 
 Ersatzteil bzw. Rep.Satz spare part or rep.-kit	05.030.1907.209, Kugelgelenk Ball Joint		

ST-Artikel
ST-Article

Vergleichs-Nr.
Comparison No.

passend für
to fit to

Details
Details

05.020.0993.890

Lenkstange
Drag Rod



85.46610.6141
85.46610.6105

25272 01

M 2000 L, TGL

795 x Ø38 x 26



i Ersatzteil bzw. Rep.Satz | spare part or rep.-kit

05.030.1907.209, Kugelgelenk | Ball Joint

05.020.0993.930

Lenkstange
Drag Rod



82.46610.6191
81.46610.6790

23466 01

E 2000, F 2000

1750 x Ø52 x 30



05.020.0993.940

Lenkstange
Drag Rod



81.46610.6798
81.46610.6578

18499 01

E 2000, F 2000, F 90

755 x Ø40 x 30



i Ersatzteil bzw. Rep.Satz | spare part or rep.-kit

05.030.0907.019, Kugelgelenk | Ball Joint
05.030.0907.029, Kugelgelenk | Ball Joint

05.020.0994.030

Lenkstange
Drag Rod



85.46610.6146
85.46610.6123

23419 01













M 2000 L, TGM

875 x Ø38 x 26



i Ersatzteil bzw. Rep.Satz | spare part or rep.-kit

05.030.1907.209, Kugelgelenk | Ball Joint

ST-Artikel ST-Article	Vergleichs-Nr. Comparison No.	passend für to fit to	Details Details
05.020.0994.110 Lenkstange Drag Rod 	81.46610.6767 81.46610.6768 25394 01	F 2000	900 x Ø38 x 30 
 Ersatzteil bzw. Rep.Satz spare part or rep.-kit	05.030.0907.019, Kugelgelenk Ball Joint 05.030.0907.029, Kugelgelenk Ball Joint		
05.020.0994.120 Lenkstange Drag Rod 	81.46610.6159 81.46610.6200 23428 01	F 2000, F 90	710 x Ø40 x 30 
 Ersatzteil bzw. Rep.Satz spare part or rep.-kit	05.030.0907.019, Kugelgelenk Ball Joint 05.030.0907.029, Kugelgelenk Ball Joint		
05.020.0994.130 Lenkstange Drag Rod 	81.46610.6761 81.46610.6762 23268 01	F 2000	687 x Ø48 x 30 
 Ersatzteil bzw. Rep.Satz spare part or rep.-kit	05.030.0907.130, Kugelgelenk Ball Joint		
05.020.0994.140 Lenkstange Drag Rod 	81.46710.6961 81.46711.6745 23304 01	E 2000, F 2000, M 2000 L	1511 x Ø52 x 30 
 Ersatzteil bzw. Rep.Satz spare part or rep.-kit	05.030.0907.130, Kugelgelenk Ball Joint		

ST-Artikel ST-Article	Vergleichs-Nr. Comparison No.	passend für to fit to	Details Details
05.020.0994.150 Lenkstange Drag Rod 	81.46610.6759 81.46610.6792 24120 01	F 2000	2687 x Ø60 x 30 
05.020.0994.160 Lenkstange Drag Rod 	81.46610.6720 81.46711.6721 24126 01	F 2000, F 90	1406 x Ø50 x 30 
 Ersatzteil bzw. Rep.Satz spare part or rep.-kit	05.030.0907.019, Kugelgelenk Ball Joint 05.030.0907.029, Kugelgelenk Ball Joint 05.030.0907.130, Kugelgelenk Ball Joint		
05.020.0994.170 Lenkstange Drag Rod 	82.46610.6057 82.46610.6147 27673 01	E 2000, F 2000	1050 x Ø52 x 30 
 Ersatzteil bzw. Rep.Satz spare part or rep.-kit	05.030.0907.029, Kugelgelenk Ball Joint		
05.020.0994.190 Lenkstange Drag Rod 	85.46610.6147 28956 01	M 2000 L, TGM	926 x Ø38 x 26 
 Ersatzteil bzw. Rep.Satz spare part or rep.-kit	05.030.0907.029, Kugelgelenk Ball Joint		

ST-Artikel ST-Article	Vergleichs-Nr. Comparison No.	passend für to fit to	Details Details
05.020.0994.250 Lenkstange Drag Rod 	85.46610.6160 85.46610.6246 31313 01	TGL	864 x Ø38 x 22 
 Ersatzteil bzw. Rep.Satz spare part or rep.-kit	05.030.1907.120, Kugelgelenk Ball Joint		
05.020.0994.260 Lenkstange Drag Rod 	81.46711.6855 81.46711.6856 31930 01	TGA, TGS	1531 x Ø42 x 30 
 Ersatzteil bzw. Rep.Satz spare part or rep.-kit	05.030.0907.019, Kugelgelenk Ball Joint 05.030.0907.029, Kugelgelenk Ball Joint 05.030.0907.130, Kugelgelenk Ball Joint		
05.020.0994.270 Lenkstange Drag Rod 	81.46611.6146 81.46611.6147 34590 01	TGA, TGS	960 x Ø50 x 30 
 Ersatzteil bzw. Rep.Satz spare part or rep.-kit	05.030.0907.130, Kugelgelenk Ball Joint		
05.020.0994.280 Lenkstange Drag Rod 	81.46611.6157 81.46611.6158 34593 01	TGA, TGS	1030 x Ø40 x 30 
 Ersatzteil bzw. Rep.Satz spare part or rep.-kit	05.030.0907.019, Kugelgelenk Ball Joint 05.030.0907.029, Kugelgelenk Ball Joint		

ST-Artikel ST-Article	Vergleichs-Nr. Comparison No.	passend für to fit to	Details Details
05.020.0994.560 Lenkstange Drag Rod 	85.46610.6103 85.46610.6032 35805 01	L 2000	874 x Ø36 x 26 
 Ersatzteil bzw. Rep.Satz spare part or rep.-kit	05.030.1907.209, Kugelgelenk Ball Joint		
05.020.0994.570 Lenkstange Drag Rod 	85.46610.6056 35811 01	TGM	926 x Ø38 x 26 
 Ersatzteil bzw. Rep.Satz spare part or rep.-kit	05.030.1907.209, Kugelgelenk Ball Joint		
05.020.0994.580 Lenkstange Drag Rod 	81.46611.6174 81.46611.6175 35807 01	TGA, TGS	1796 x Ø62 x 30 
05.030.0280.210 Kugelgelenk Ball Joint 	82.95301.0009 18461 01 31708 01	MAN	85 x 38 / M26 x 1,5 

ST-Artikel ST-Article	Vergleichs-Nr. Comparison No.	passend für to fit to	Details Details
05.030.0280.220 Kugelgelenk Ball Joint 	81.95301.6270 23763 01	M 2000 L, M 2000 M, TGM	150 x 26 / M30 x 1,5 
 Ersatzteil bzw. Rep.Satz spare part or rep.-kit	05.010.0994.530, Spurstange Tie Rod		
05.030.0906.610 Kugelgelenk Ball Joint 	81.95301.6263 11572 01	F 2000, F 90, 16 t - Serie, 17 t - Serie, 20/22 t - Serie, 24 t - Serie, 26 t - Serie, 30 t - Se- rie, 32 t - Serie, 33 t - Serie	160 x 30 / M30 x 1,5 
05.030.0907.019 Kugelgelenk Ball Joint 	81.95301.6351 81.95301.6275 11492 03 11492 02 11390 01	F 2000, F 90, M 2000 L, M 2000 M, TGA, TGS, TGX	125 x 30 / M30 x 1,5 
 Ersatzteil bzw. Rep.Satz spare part or rep.-kit	05.010.0280.900, Spurstange Tie Rod 05.010.0803.630, Spurstange Tie Rod 05.010.0994.510, Spurstange Tie Rod 05.010.1913.460, Spurstange Tie Rod 05.010.4007.067, Spurstange Tie Rod 05.010.4007.068, Spurstange Tie Rod 05.010.4256.320, Spurstange Tie Rod 05.010.4256.330, Spurstange Tie Rod 05.010.4256.350, Spurstange Tie Rod 05.020.0280.820, Lenkstange Drag Rod 05.020.0280.830, Lenkstange Drag Rod 05.020.0994.110, Lenkstange Drag Rod 05.020.0994.120, Lenkstange Drag Rod 05.020.0994.160, Lenkstange Drag Rod 05.020.0994.260, Lenkstange Drag Rod 05.020.0994.280, Lenkstange Drag Rod		
Komplementärteil complementary part	05.030.0907.029, Kugelgelenk Ball Joint		

05.030.0907.029

Kugelgelenk
Ball Joint



81.95301.6350
81.95301.6308

F 2000, F 90, M 2000 L,
M 2000 M, M 90, TGA, TGS, TGX

125 x 30 / M30 x 1,5

11505 03
11505 02
11389 01



Ersatzteil bzw. Rep.Satz | spare
part or rep.-kit

05.010.0280.900, Spurstange | Tie Rod
05.010.0803.630, Spurstange | Tie Rod
05.010.0994.510, Spurstange | Tie Rod
05.010.0994.550, Spurstange | Tie Rod
05.010.1913.460, Spurstange | Tie Rod
05.010.1913.510, Spurstange | Tie Rod
05.010.4007.067, Spurstange | Tie Rod
05.010.4007.068, Spurstange | Tie Rod
05.010.4256.320, Spurstange | Tie Rod
05.010.4256.330, Spurstange | Tie Rod
05.010.4256.350, Spurstange | Tie Rod
05.020.0280.390, Lenkstange | Drag Rod
05.020.0280.830, Lenkstange | Drag Rod
05.020.0803.760, Lenkstange | Drag Rod
05.020.0803.770, Lenkstange | Drag Rod
05.020.0803.780, Lenkstange | Drag Rod
05.020.0994.110, Lenkstange | Drag Rod
05.020.0994.120, Lenkstange | Drag Rod
05.020.0994.160, Lenkstange | Drag Rod
05.020.0994.170, Lenkstange | Drag Rod
05.020.0994.190, Lenkstange | Drag Rod
05.020.0994.260, Lenkstange | Drag Rod
05.020.0994.280, Lenkstange | Drag Rod
05.020.1913.250, Lenkstange | Drag Rod
05.020.1913.290, Lenkstange | Drag Rod
05.020.1913.330, Lenkstange | Drag Rod
05.020.1913.360, Lenkstange | Drag Rod
05.020.1913.370, Lenkstange | Drag Rod
05.020.1913.380, Lenkstange | Drag Rod
05.020.1913.410, Lenkstange | Drag Rod
05.020.4256.370, Lenkstange | Drag Rod

Komplementärteil | complemen-
tary part

05.030.0907.019, Kugelgelenk | Ball Joint

05.030.0907.030

Kugelgelenk
Ball Joint



81.95301.6238
82.95301.6015

TGA, TGS, TGX

80 x 30 / M30 x 1,5

25165 01



ST-Artikel ST-Article	Vergleichs-Nr. Comparison No.	passend für to fit to	Details Details
05.030.0907.130 Kugelgelenk Ball Joint 	81.95301.6286 25353 01	F 2000, F 90, L 2000, TGA, TGM, TGS, TGX	140 x 30 / M30 x 1,5 
 Ersatzteil bzw. Rep.Satz spare part or rep.-kit	05.010.0280.380, Spurstange Tie Rod 05.010.0994.520, Spurstange Tie Rod 05.010.3001.910, Spurstange Tie Rod 05.020.0280.820, Lenkstange Drag Rod 05.020.0994.140, Lenkstange Drag Rod 05.020.0994.270, Lenkstange Drag Rod		
05.030.0907.200 Kugelgelenk Ball Joint 	82.95301.6019 81.95301.6268 30756 01	E 2000, F 2000, TGA, TGS	86 x 38 / M30 x 1,5 
05.030.0993.860 Kugelgelenk Ball Joint 	81.95301.6271 81.95301.6325 27853 01	F 2000, TGA, TGM, TGS, TGX	145 x 30 / M30 x 1,5 
 Ersatzteil bzw. Rep.Satz spare part or rep.-kit	05.010.0280.910, Spurstange Tie Rod 05.010.3001.920, Spurstange Tie Rod		
05.030.0993.870 Kugelgelenk Ball Joint 	81.95301.6291 81.95301.6225 21075 01	E 2000, F 2000, F 90	80 x 30 / M26 x 1,5 

ST-Artikel ST-Article	Vergleichs-Nr. Comparison No.	passend für to fit to	Details Details
05.030.0994.290 Kugelgelenk Ball Joint 	81.95301.6280 82.95301.0010 33772 01	F 2000, TGA, TGS, TGX	75 x 30 / M30 x 1,5 
05.030.1907.120 Kugelgelenk Ball Joint 	81.95301.6328 81.95301.6316 11378 01	G, G 90, L 2000, M 2000 L, TGL	101 x 22 / M28 x 1,5 
<i>i</i> Ersatzteil bzw. Rep.Satz spare part or rep.-kit Komplementärteil complementary part	05.010.1913.480, Spurstange Tie Rod 05.020.0994.250, Lenkstange Drag Rod 05.030.1907.160, Kugelgelenk Ball Joint		
05.030.1907.160 Kugelgelenk Ball Joint 	81.90685.0387 81.95301.6329 11379 01	G, L 2000, M 2000 L	101 x 22 / M28 xx 1,5 
<i>i</i> Komplementärteil complementary part	05.030.1907.120, Kugelgelenk Ball Joint		
05.030.1907.180 Kugelgelenk Ball Joint 	81.95301.6303 81.95301.6321 11376 02 11376 01 19667 01	G, G 90, L 2000, TGL	95 x 20 / M24 x 1,5 
<i>i</i> Komplementärteil complementary part	05.030.1907.190, Kugelgelenk Ball Joint		

ST-Artikel ST-Article	Vergleichs-Nr. Comparison No.	passend für to fit to	Details Details
05.030.1907.190 Kugelgelenk Ball Joint 	81.95301.6322 81.95301.6304 11377 03 11377 01	G, G 90, L 2000	95 x 20 / M24 x 1,5 
 Komplementärteil complemen- tary part	05.030.1907.180, Kugelgelenk Ball Joint		
05.030.1907.209 Kugelgelenk Ball Joint 	81.95301.6272 81.95301.6360 11402 01 25718 01 24570 01	L 2000, M 2000 L, M 2000 M, M 90, MAN, TGL, TGM	120 x 26 / M30 x 1,5 
 Ersatzteil bzw. Rep.Satz spare part or rep.-kit	05.010.1913.500, Spurstange Tie Rod 05.020.0280.800, Lenkstange Drag Rod 05.020.0994.560, Lenkstange Drag Rod 05.020.0994.570, Lenkstange Drag Rod 05.020.1913.280, Lenkstange Drag Rod 05.020.4007.084, Lenkstange Drag Rod 05.020.4007.085, Lenkstange Drag Rod		
Komplementärteil complemen- tary part	05.030.1907.549, Kugelgelenk Ball Joint		
05.030.1907.549 Kugelgelenk Ball Joint 	81.95301.6361 81.95301.6273 11403 01 11728 01 19675 01	M 2000 L, M 90	120 x 26 / M30 x 1,5 
 Komplementärteil complemen- tary part	05.030.1907.209, Kugelgelenk Ball Joint		

ST-Artikel ST-Article	Vergleichs-Nr. Comparison No.	passend für to fit to	Details Details
05.030.1907.980 Kugelgelenk Ball Joint	81.95301.6151 90.80415.4117 11388 01	MAN	125 x 26 / M30 x 1,5 
	05.030.1910.700 Kugelgelenk Ball Joint	81.95301.6324 11394 04 11394 03	MAN
	05.010.1913.430, Spurstange Tie Rod 05.020.1913.210, Lenkstange Drag Rod 05.020.1913.240, Lenkstange Drag Rod 05.020.1913.260, Lenkstange Drag Rod 05.020.1913.300, Lenkstange Drag Rod 05.020.1913.350, Lenkstange Drag Rod 05.020.1913.390, Lenkstange Drag Rod 05.030.1910.440, Kugelgelenk Ball Joint	125 x 32 / M30 x 1,5 	<p>i Ersatzteil bzw. Rep.Satz spare part or rep.-kit</p> <p>Komplementärteil complementary part</p>
05.030.1910.980 Kugelgelenk Ball Joint	81.95301.6297 19615 01	E 2000	135 x 38 / M38 x 1,5 
	05.030.0610.330, Kugelgelenk Ball Joint	<p>i Komplementärteil complementary part</p>	

ST-Artikel ST-Article	Vergleichs-Nr. Comparison No.	passend für to fit to	Details Details
05.030.1980.970 Kugelgelenk Ball Joint 	81.95301.6276 81.95301.6251	TGA	125 x 30 / M38 x 1,5 
05.030.3040.110 Kugelgelenk Ball Joint 	81.95301.6288 21440 01 11393 01	M 2000 L, M 2000 M, TGA	150 x 30 / M30 x 1,5 
 Ersatzteil bzw. Rep.Satz spare part or rep.-kit	05.010.4256.360, Spurstange Tie Rod		
05.050.0916.100 Hydraulikpumpe, Lenkung Hydraulic Pump, Steering 	81.47101.6122 81.47101.6137 7685 955 324 7685 955 180 542 0023 10	L 2000, M 2000 L, M 2000 M, TGA, TGL, TGM, TGX	M26x1,5 / M18x1,5 
05.050.0916.110 Hydraulikpumpe, Lenkung Hydraulic Pump, Steering 	81.47101.6082 81.47101.6086 7685.955.325	E 2000, F 2000, F 90, L 2000, M 2000 L, TGA, TGS, TGX	M26x1,5 / M18x1,5 



passend für | to fit to **MAN**

ST-Artikel
ST-Article

Vergleichs-Nr.
Comparison No.

passend für
to fit to

Details
Details

05.050.0916.120

Hydraulikpumpe, Lenkung
Hydraulic Pump, Steering



81.47101.9189
81.47101.6040

7685.955.359

TGA













M26x1,5 / M18x1,5















passend für
to fit to

Mercedes-Benz









LKW
Truck













ST-Artikel ST-Article	Vergleichs-Nr. Comparison No.	passend für to fit to	Details Details
05.010.1910.201 Spurstange Tie Rod 	405 330 02 03 405 330 01 03 33398 01	Unimog	1226 x Ø40 x 26 
 Ersatzteil bzw. Rep.Satz spare part or rep.-kit	05.030.1907.209, Kugelgelenk Ball Joint 05.030.1907.549, Kugelgelenk Ball Joint		
05.010.1910.230 Spurstange Tie Rod 	385 330 14 03 385 330 15 03 12865 01	LK/LN2, MK, NG	1611 x Ø46 x 26 
 Ersatzteil bzw. Rep.Satz spare part or rep.-kit	05.030.1907.209, Kugelgelenk Ball Joint 05.030.1907.549, Kugelgelenk Ball Joint		
05.010.1910.310 Spurstange Tie Rod 	944 330 05 03 346 330 49 03 24315 01 23997 01	Actros, Actros MP2 / MP3, Atego, Axor 2	1588 x Ø58 x 30 
 Ersatzteil bzw. Rep.Satz spare part or rep.-kit	05.030.0907.029, Kugelgelenk Ball Joint		
05.010.1910.320 Spurstange Tie Rod 	393 330 07 03 393 330 04 03 11439 01	LK/LN2, MK, NG, SK	1615 x Ø50 x 30 
 Ersatzteil bzw. Rep.Satz spare part or rep.-kit	05.030.0907.019, Kugelgelenk Ball Joint 05.030.0907.029, Kugelgelenk Ball Joint		

ST-Artikel ST-Article	Vergleichs-Nr. Comparison No.	passend für to fit to	Details Details
05.010.1910.370 Spurstange Tie Rod 	676 330 07 03 676 330 09 03 12879 01	LK/LN2	1550 x Ø40 x 22 
 Ersatzteil bzw. Rep.Satz spare part or rep.-kit	05.030.1907.120, Kugelgelenk Ball Joint 05.030.1907.160, Kugelgelenk Ball Joint		
05.010.1910.380 Spurstange Tie Rod 	676 330 08 03 676 330 10 03 18446 01	LK/LN2	1540 x Ø40 x 26 
 Ersatzteil bzw. Rep.Satz spare part or rep.-kit	05.030.1907.209, Kugelgelenk Ball Joint 05.030.1907.549, Kugelgelenk Ball Joint		
05.010.1910.520 Spurstange Tie Rod 	941 330 02 03 941 330 01 03 23988 01	Actros, Actros MP2 / MP3, Atego, Axor, Axor 2	1745 x Ø48 x 32 
 Ersatzteil bzw. Rep.Satz spare part or rep.-kit	05.030.1910.440, Kugelgelenk Ball Joint 05.030.1910.700, Kugelgelenk Ball Joint		
05.010.1910.530 Spurstange Tie Rod 	942 330 24 03 942 330 16 03 30478 01	Actros, Actros MP2 / MP3, Atego, Axor 2	1664 x Ø50 x 32 
 Ersatzteil bzw. Rep.Satz spare part or rep.-kit	05.030.1910.440, Kugelgelenk Ball Joint 05.030.1910.700, Kugelgelenk Ball Joint		

ST-Artikel ST-Article	Vergleichs-Nr. Comparison No.	passend für to fit to	Details Details
05.010.1910.790 Spurstange Tie Rod 	677 330 03 03 677 330 04 03 18448 01	LK/LN2, SK	1570 x Ø40 x 26 
 Ersatzteil bzw. Rep.Satz spare part or rep.-kit	05.030.1907.209, Kugelgelenk Ball Joint 05.030.1907.549, Kugelgelenk Ball Joint		
05.010.1910.830 Spurstange Tie Rod 	942 330 00 03 942 330 23 03 37332 01	Actros, Actros MP2 / MP3, Atego, Axor, Axor 2, Econic	1735 x Ø52 x 32 
 Ersatzteil bzw. Rep.Satz spare part or rep.-kit	05.030.1910.700, Kugelgelenk Ball Joint		
05.010.1911.510 Spurstange Tie Rod 	970 330 04 03 970 330 02 03 23977 01	Atego, Atego 2, Atego 3	1640 x Ø40 x 26 
 Ersatzteil bzw. Rep.Satz spare part or rep.-kit	05.030.1907.209, Kugelgelenk Ball Joint 05.030.1907.549, Kugelgelenk Ball Joint		
05.010.1911.520 Spurstange Tie Rod 	949 330 04 03 949 330 23 03 37330 01	Actros, Actros MP2 / MP3, Atego, Axor 2	1700 x Ø52 x 32 
 Ersatzteil bzw. Rep.Satz spare part or rep.-kit	05.030.1910.700, Kugelgelenk Ball Joint		









ST-Artikel ST-Article	Vergleichs-Nr. Comparison No.	passend für to fit to	Details Details
05.010.1911.630 Spurstange Tie Rod 	945 330 06 03 945 330 09 03 37329 01	Actros, Actros MP2 / MP3, Atego, Axor 2, Econic	1735 x Ø62 x 32 
05.010.1911.740 Spurstange Tie Rod 	949 330 17 03 949 330 10 03 23994 01	Actros, Actros MP2 / MP3, Axor 2	1596 x Ø50 x 32 
 Ersatzteil bzw. Rep.Satz spare part or rep.-kit	05.030.1910.440, Kugelgelenk Ball Joint 05.030.1910.700, Kugelgelenk Ball Joint		
05.010.1911.750 Spurstange Tie Rod 	617 330 02 03 617 330 03 03 22418 01	LK/LN2, NG, SK	1610 x Ø46 x 30 
 Ersatzteil bzw. Rep.Satz spare part or rep.-kit	05.030.0907.019, Kugelgelenk Ball Joint 05.030.0907.029, Kugelgelenk Ball Joint		
05.010.1912.330 Spurstange Tie Rod 	620 330 05 03 620 330 06 03 19947 01	MK, NG, SK	1670 x Ø50 x 30 
 Ersatzteil bzw. Rep.Satz spare part or rep.-kit	05.030.0907.019, Kugelgelenk Ball Joint 05.030.0907.029, Kugelgelenk Ball Joint		

ST-Artikel ST-Article	Vergleichs-Nr. Comparison No.	passend für to fit to	Details Details
05.010.1912.350 Spurstange Tie Rod 	949 330 02 03 949 330 03 03 23992 01	Actros, Actros MP2 / MP3, Atego, Axor 2	1615 x Ø50 x 32 
 Ersatzteil bzw. Rep.Satz spare part or rep.-kit	05.030.1910.440, Kugelgelenk Ball Joint 05.030.1910.700, Kugelgelenk Ball Joint		
05.010.1912.370 Spurstange Tie Rod 	424 330 03 03 23970 01	Unimog	1170 x Ø46 x 26 
 Ersatzteil bzw. Rep.Satz spare part or rep.-kit	05.030.1907.209, Kugelgelenk Ball Joint		
05.010.1912.380 Spurstange Tie Rod 	975 330 02 03 23996 01	Atego, Atego 2, Atego 3	1605 x Ø40 x 30 
 Ersatzteil bzw. Rep.Satz spare part or rep.-kit	05.030.0907.019, Kugelgelenk Ball Joint 05.030.0907.029, Kugelgelenk Ball Joint		
05.010.1912.420 Spurstange Tie Rod 	385 330 16 03 385 330 18 03 13556 01	NG	1635 x Ø52 x 26 
 Ersatzteil bzw. Rep.Satz spare part or rep.-kit	05.030.1907.209, Kugelgelenk Ball Joint		

ST-Artikel ST-Article	Vergleichs-Nr. Comparison No.	passend für to fit to	Details Details
05.010.1912.430 Spurstange Tie Rod 	945 330 05 03 945 330 03 03 23989 01	Actros, Actros MP2 / MP3, Atego, Axor 2, Econic	1465 x Ø40 x 32 
 Ersatzteil bzw. Rep.Satz spare part or rep.-kit	05.030.1910.440, Kugelgelenk Ball Joint 05.030.1910.700, Kugelgelenk Ball Joint		
05.010.1912.460 Spurstange Tie Rod 	416 330 00 03 13560 01	Unimog	1132 x Ø46 x 22 
 Ersatzteil bzw. Rep.Satz spare part or rep.-kit	05.030.1980.860, Kugelgelenk Ball Joint		
05.010.1912.590 Spurstange Tie Rod 	385 330 21 03 385 330 22 03 20397 01	LK/LN2, MK, NG	1635 x Ø60 x 30 
 Ersatzteil bzw. Rep.Satz spare part or rep.-kit	05.030.0907.029, Kugelgelenk Ball Joint		
05.010.1912.670 Spurstange Tie Rod 	942 330 05 03 942 330 06 03 22807 01	Actros, Atego, Axor 2	1565 x Ø50 x 32 
 Ersatzteil bzw. Rep.Satz spare part or rep.-kit	05.030.1910.440, Kugelgelenk Ball Joint 05.030.1910.700, Kugelgelenk Ball Joint		

ST-Artikel ST-Article	Vergleichs-Nr. Comparison No.	passend für to fit to	Details Details
05.010.1912.690 Spurstange Tie Rod 	944 330 02 03 625 330 12 03 20430 01	Actros, Actros MP2 / MP3, Arocs, Atego, Axor 2, Zetros	1588 x Ø60 x 38 
 Ersatzteil bzw. Rep.Satz spare part or rep.-kit	05.030.1910.980, Kugelgelenk Ball Joint		
05.010.1912.700 Spurstange Tie Rod 	346 330 48 03 346 330 40 03 19721 01	Actros, Atego, Axor 2, SK	1438 x Ø58 x 30 
 Ersatzteil bzw. Rep.Satz spare part or rep.-kit	05.030.0907.029, Kugelgelenk Ball Joint		
05.010.1912.940 Spurstange Tie Rod 	949 330 16 03 949 330 06 03 37331 01 23990 01	Actros, Actros MP2 / MP3, Atego, Axor, Axor 2	1687 x Ø52 x 32 
 Ersatzteil bzw. Rep.Satz spare part or rep.-kit	05.030.1910.700, Kugelgelenk Ball Joint		
05.010.1913.430 Spurstange Tie Rod 	949 330 12 03 949 330 13 03 23995 01	Actros, Actros MP2 / MP3, Atego, Axor 2	1532 x Ø50 x 32 
 Ersatzteil bzw. Rep.Satz spare part or rep.-kit	05.030.1910.440, Kugelgelenk Ball Joint 05.030.1910.700, Kugelgelenk Ball Joint		











ST-Artikel ST-Article	Vergleichs-Nr. Comparison No.	passend für to fit to	Details Details
05.010.1913.440 Spurstange Tie Rod 	960 330 01 03 37258 01 36540 01	Actros MP4, Antos, Arocs	1685 x Ø50 x 32 
05.010.1913.460 Spurstange Tie Rod 	357 460 35 05 942 330 10 03 24311 01	Actros MP2 / MP3, Atego, Axor 2	1281 x Ø38 x 30 
 Ersatzteil bzw. Rep.Satz spare part or rep.-kit	05.030.0907.019, Kugelgelenk Ball Joint 05.030.0907.029, Kugelgelenk Ball Joint 05.030.1910.700, Kugelgelenk Ball Joint		
05.010.1913.480 Spurstange Tie Rod 	669 330 06 03 669 330 07 03 23962 01	T2/LN1	1501 x Ø44 x 22 
 Ersatzteil bzw. Rep.Satz spare part or rep.-kit	05.030.1907.120, Kugelgelenk Ball Joint		
05.010.1913.500 Spurstange Tie Rod 	676 330 06 03 676 330 13 03 23972 01	Atego, Atego 2	1435 x Ø52 x 26 
 Ersatzteil bzw. Rep.Satz spare part or rep.-kit	05.030.1907.209, Kugelgelenk Ball Joint		

ST-Artikel ST-Article	Vergleichs-Nr. Comparison No.	passend für to fit to	Details Details
05.010.1913.510 Spurstange Tie Rod 	975 330 00 03 975 330 04 03 23998 01	Atego, Atego 2, Atego 3	1565 x Ø60 x 30 
<i>i</i> Ersatzteil bzw. Rep.Satz spare part or rep.-kit	05.030.0907.029, Kugelgelenk Ball Joint		
05.020.1907.010 Lenkstange Drag Rod 	316 460 08 05 316 460 06 05 11417 03	LP	533 x Ø36 x 22 
<i>i</i> Ersatzteil bzw. Rep.Satz spare part or rep.-kit	05.030.1907.150, Kugelgelenk Ball Joints		
05.020.1907.070 Lenkstange Drag Rod 	647 460 00 05 647 460 01 05 30911 01	MK, NG, SK	870 x Ø40 x 30 
<i>i</i> Ersatzteil bzw. Rep.Satz spare part or rep.-kit	05.030.0907.029, Kugelgelenk Ball Joint		
05.020.1907.250 Lenkstange Drag Rod 	002 460 96 05 002 460 97 05 27683 01	Actros, Actros MP2 / MP3	860 x Ø40 x 28,6 
<i>i</i> Ersatzteil bzw. Rep.Satz spare part or rep.-kit	05.030.1912.610, Kugelgelenk Ball Joint		

ST-Artikel ST-Article	Vergleichs-Nr. Comparison No.	passend für to fit to	Details Details
05.020.1907.330 Lenkstange Drag Rod 	383 460 44 05 383 460 23 05 11435 01	LK/LN2, NG	890 x Ø42 x 26 
 Ersatzteil bzw. Rep.Satz spare part or rep.-kit	05.030.1907.980, Kugelgelenk Ball Joint		
05.020.1907.340 Lenkstange Drag Rod 	383 460 45 05 383 460 24 05 12905 01	LK/LN2, NG	895 x Ø40 x 22 
 Ersatzteil bzw. Rep.Satz spare part or rep.-kit	05.030.1907.150, Kugelgelenk Ball Joints		
05.020.1907.390 Lenkstange Drag Rod 	385 460 34 05 385 460 20 05 13557 01	NG	865 x Ø42 x 26 
 Ersatzteil bzw. Rep.Satz spare part or rep.-kit	05.030.1907.209, Kugelgelenk Ball Joint		
05.020.1907.500 Lenkstange Drag Rod 	387 460 44 05 387 460 45 05 11438 01	NG	865 x Ø40 x 26 
 Ersatzteil bzw. Rep.Satz spare part or rep.-kit	05.030.1907.980, Kugelgelenk Ball Joint		













ST-Artikel ST-Article	Vergleichs-Nr. Comparison No.	passend für to fit to	Details Details
05.020.1910.241 Lenkstange Drag Rod 	972 460 15 05 972 460 17 05 24242 01	Atego, Atego 2	837 x Ø40 x 26 
 Ersatzteil bzw. Rep.Satz spare part or rep.-kit	05.030.1907.209, Kugelgelenk Ball Joint		
05.020.1910.242 Lenkstange Drag Rod 	002 460 10 05 003 460 29 05 27441 01	Actros, Actros MP2 / MP3	2069 x Ø40 x 30 
05.020.1910.280 Lenkstange Drag Rod 	620 460 28 05 620 460 37 05 30912 01 11460 01	MK, NG, SK	885 x Ø40 x 30 
 Ersatzteil bzw. Rep.Satz spare part or rep.-kit	05.030.0907.029, Kugelgelenk Ball Joint		
05.020.1910.330 Lenkstange Drag Rod 	673 460 06 05 673 460 08 05 11475 01	LK/LN2	725 x Ø36 x 22 
 Ersatzteil bzw. Rep.Satz spare part or rep.-kit	05.030.1907.150, Kugelgelenk Ball Joints		











ST-Artikel ST-Article	Vergleichs-Nr. Comparison No.	passend für to fit to	Details Details
05.020.1910.340 Lenkstange Drag Rod 	619 460 52 05 619 460 29 05 11457 01	MK, NG, SK	860 x Ø42 x 30 
 Ersatzteil bzw. Rep.Satz spare part or rep.-kit	05.030.0907.029, Kugelgelenk Ball Joint		
05.020.1910.390 Lenkstange Drag Rod 	617 460 28 05 617 460 02 05 11454 01	NG	870 x Ø42 x 26 
 Ersatzteil bzw. Rep.Satz spare part or rep.-kit	05.030.1907.980, Kugelgelenk Ball Joint		
05.020.1910.430 Lenkstange Drag Rod 	675 460 22 05 675 460 28 05 11477 01	LK/LN2	785 x Ø40 x 26 
 Ersatzteil bzw. Rep.Satz spare part or rep.-kit	05.030.1907.980, Kugelgelenk Ball Joint		
05.020.1910.600 Lenkstange Drag Rod 	676 460 11 05 676 460 15 05 12936 01	LK/LN2	780 x Ø40 x 26 
 Ersatzteil bzw. Rep.Satz spare part or rep.-kit	05.030.1907.980, Kugelgelenk Ball Joint		

ST-Artikel ST-Article	Vergleichs-Nr. Comparison No.	passend für to fit to	Details Details
05.020.1910.610 Lenkstange Drag Rod 	675 460 24 05 675 460 30 05 12935 01	LK/LN2	720 x Ø40 x 26 
	Ersatzteil bzw. Rep.Satz spare part or rep.-kit	05.030.1907.980, Kugelgelenk Ball Joint	
05.020.1910.620 Lenkstange Drag Rod 	000 460 71 05 001 460 67 05 19904 01	Actros, Actros MP2 / MP3	879 x Ø42 x 30 
	Ersatzteil bzw. Rep.Satz spare part or rep.-kit	05.030.0907.029, Kugelgelenk Ball Joint	
05.020.1910.630 Lenkstange Drag Rod 	001 460 29 05 001 460 30 05 19699 01	MK	840 x Ø52 x 32 
	Ersatzteil bzw. Rep.Satz spare part or rep.-kit	05.030.1910.700, Kugelgelenk Ball Joint	
05.020.1910.640 Lenkstange Drag Rod 	002 460 44 05 002 460 43 05 24243 01	Actros, Actros MP2 / MP3, Axor, Axor 2	872 x Ø35 x 28,6 
	Ersatzteil bzw. Rep.Satz spare part or rep.-kit	05.030.1912.621, Kugelgelenk Ball Joint	













ST-Artikel ST-Article	Vergleichs-Nr. Comparison No.	passend für to fit to	Details Details
05.020.1910.650 Lenkstange Drag Rod 	001 460 03 05 001 460 04 05 12881 01	MK, NG, SK	840 x Ø48 x 32 
 Ersatzteil bzw. Rep.Satz spare part or rep.-kit	05.030.1910.700, Kugelgelenk Ball Joint		
05.020.1910.660 Lenkstange Drag Rod 	002 460 48 05 002 460 47 05 24244 01	Actros, Actros MP2 / MP3	875 x Ø40 x 28,6 
 Ersatzteil bzw. Rep.Satz spare part or rep.-kit	05.030.1912.610, Kugelgelenk Ball Joint		
05.020.1910.680 Lenkstange Drag Rod 	617 460 34 05 617 460 24 05 24276 01	MK, NG	862 x Ø42 x 30 
 Ersatzteil bzw. Rep.Satz spare part or rep.-kit	05.030.0907.029, Kugelgelenk Ball Joint		
05.020.1910.730 Lenkstange Drag Rod 	625 460 25 05 12925 01	MK, NG, SK	870 x Ø42 x 30 
 Ersatzteil bzw. Rep.Satz spare part or rep.-kit	05.030.0907.029, Kugelgelenk Ball Joint		









ST-Artikel ST-Article	Vergleichs-Nr. Comparison No.	passend für to fit to	Details Details
05.020.1910.750 Lenkstange Drag Rod	970 460 07 05 970 460 09 05 24239 01	Atego, Atego 2	846 x Ø42 x 26
			
 Ersatzteil bzw. Rep.Satz spare part or rep.-kit	05.030.1907.209, Kugelgelenk Ball Joint		
05.020.1910.820 Lenkstange Drag Rod	673 460 07 05 673 460 09 05 11476 01	LK/LN2	735 x Ø36 x 22
			
 Ersatzteil bzw. Rep.Satz spare part or rep.-kit	05.030.1907.150, Kugelgelenk Ball Joints		
05.020.1911.440 Lenkstange Drag Rod	002 460 60 05 003 460 41 05 27628 01	Actros, Actros MP2 / MP3	935 x Ø38 x 32
			
 Ersatzteil bzw. Rep.Satz spare part or rep.-kit	05.030.1910.700, Kugelgelenk Ball Joint		
05.020.1911.450 Lenkstange Drag Rod	974 460 11 05 974 460 13 05 26024 01	Atego, Atego 2	894 x Ø50 x 30
			
 Ersatzteil bzw. Rep.Satz spare part or rep.-kit	05.030.0907.029, Kugelgelenk Ball Joint		

ST-Artikel ST-Article	Vergleichs-Nr. Comparison No.	passend für to fit to	Details Details
05.020.1911.460 Lenkstange Drag Rod 	375 460 06 05 375 460 11 05 34003 01	Axor, Axor 2	905 x Ø42 x 28,6 
 Ersatzteil bzw. Rep.Satz spare part or rep.-kit	05.030.1912.610, Kugelgelenk Ball Joint		
05.020.1911.530 Lenkstange Drag Rod 	972 460 18 05 003 460 59 05 25154 01	Atego, Atego 2	895 x Ø50 x 30 
 Ersatzteil bzw. Rep.Satz spare part or rep.-kit	05.030.0907.029, Kugelgelenk Ball Joint		
05.020.1911.550 Lenkstange Drag Rod 	002 460 52 05 003 460 40 05 27954 01	Actros, Actros MP2 / MP3, Atego, Axor 2	885 x Ø38 x 32 
 Ersatzteil bzw. Rep.Satz spare part or rep.-kit	05.030.1910.700, Kugelgelenk Ball Joint		
05.020.1911.560 Lenkstange Drag Rod 	000 460 98 05 000 460 99 05 20892 01	SK	895 x Ø48 x 30 
 Ersatzteil bzw. Rep.Satz spare part or rep.-kit	05.030.0907.029, Kugelgelenk Ball Joint		



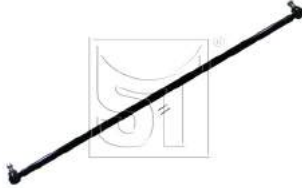









ST-Artikel ST-Article	Vergleichs-Nr. Comparison No.	passend für to fit to	Details Details
05.020.1911.580 Lenkstange Drag Rod 	974 460 10 05 974 460 12 05 25821 01	Atego, Atego 2	895 x Ø50 x 30 
 Ersatzteil bzw. Rep.Satz spare part or rep.-kit	05.030.0907.029, Kugelgelenk Ball Joint		
05.020.1911.590 Lenkstange Drag Rod 	001 460 69 05 000 460 93 05 21412 01	Actros	875 x Ø40 x 30 
 Ersatzteil bzw. Rep.Satz spare part or rep.-kit	05.030.0907.029, Kugelgelenk Ball Joint		
05.020.1911.620 Lenkstange Drag Rod 	002 460 50 05 003 460 56 05 25447 01	Atego, Axor, Axor 2	895 x Ø40 x 28,6 
 Ersatzteil bzw. Rep.Satz spare part or rep.-kit	05.030.1912.610, Kugelgelenk Ball Joint		
05.020.1911.650 Lenkstange Drag Rod 	002 460 05 05 001 460 13 05 25249 01	Actros, Actros MP2 / MP3, Axor 2	1095 x Ø42 x 32 

ST-Artikel ST-Article	Vergleichs-Nr. Comparison No.	passend für to fit to	Details Details
05.020.1911.660 Lenkstange Drag Rod 	002 460 04 05 003 460 31 05 25250 01	Actros, Actros MP2 / MP3	711 x Ø42 x 32 
05.020.1911.670 Lenkstange Drag Rod 	620 460 29 05 620 460 30 05 12923 01	MK, NG, SK	862 x Ø40 x 30 
 Ersatzteil bzw. Rep.Satz spare part or rep.-kit	05.030.0907.029, Kugelgelenk Ball Joint		
05.020.1911.690 Lenkstange Drag Rod 	002 460 46 05 003 460 50 05 25721 01	Actros, Actros MP2 / MP3, Atego, Axor, Axor 2	890 x Ø35 x 28,6 
 Ersatzteil bzw. Rep.Satz spare part or rep.-kit	05.030.1912.621, Kugelgelenk Ball Joint		
05.020.1911.710 Lenkstange Drag Rod 	001 460 71 05 000 460 95 05 23470 01	Actros, Actros MP2 / MP3	904 x Ø52 x 32 
 Ersatzteil bzw. Rep.Satz spare part or rep.-kit	05.030.1910.700, Kugelgelenk Ball Joint		

ST-Artikel ST-Article	Vergleichs-Nr. Comparison No.	passend für to fit to	Details Details
05.020.1911.760 Lenkstange Drag Rod 	437 460 01 05 425 460 01 05 13563 01	Unimog	1000 x Ø38 x 26 
	Ersatzteil bzw. Rep.Satz spare part or rep.-kit	05.030.1907.209, Kugelgelenk Ball Joint	
05.020.1911.890 Lenkstange Drag Rod 	001 460 70 05 001 460 07 05 23476 01	Actros	888 x Ø38 x 30 
	Ersatzteil bzw. Rep.Satz spare part or rep.-kit	05.030.0907.029, Kugelgelenk Ball Joint	
05.020.1911.920 Lenkstange Drag Rod 	676 460 19 05 676 460 21 05 18447 01	LK/LN2	783 x Ø42 x 26 
	Ersatzteil bzw. Rep.Satz spare part or rep.-kit	05.030.1907.980, Kugelgelenk Ball Joint	
05.020.1911.960 Lenkstange Drag Rod 	406 460 07 05 406 460 06 05 13559 01	Unimog	1015 x Ø38 x 26 
	Ersatzteil bzw. Rep.Satz spare part or rep.-kit	05.030.1907.209, Kugelgelenk Ball Joint	

ST-Artikel ST-Article	Vergleichs-Nr. Comparison No.	passend für to fit to	Details Details
05.020.1911.980 Lenkstange Drag Rod 	000 460 44 05 625 460 50 05 19695 01	MK, NG, SK	1115 x Ø52 x 32 
05.020.1912.170 Lenkstange Drag Rod 	000 460 43 05 625 460 48 05 19694 01	MK, NG, SK	680 x Ø42 x 32 
05.020.1912.180 Lenkstange Drag Rod 	002 460 12 05 001 460 61 05 24309 01	Actros, Actros MP2 / MP3, Atego	1863 x Ø42 x 30 
05.020.1912.190 Lenkstange Drag Rod 	001 460 81 05 001 460 51 05 24303 01	Actros, Actros MP2 / MP3	905 x Ø42 x 30 
 Ersatzteil bzw. Rep.Satz spare part or rep.-kit	05.030.0907.029, Kugelgelenk Ball Joint		

ST-Artikel ST-Article	Vergleichs-Nr. Comparison No.	passend für to fit to	Details Details
05.020.1912.220 Lenkstange Drag Rod	001 460 86 05 001 460 87 05 24304 01	Actros, Actros MP2 / MP3, Atego	954 x Ø42 x 30 
			
05.020.1912.250 Lenkstange Drag Rod	001 460 90 05 001 460 91 05 24305 01	Atego	1558 x Ø52 x 30 
			
05.020.1912.260 Lenkstange Drag Rod	002 460 13 05 001 460 89 05 24310 01	Actros, Actros MP2 / MP3, Atego	1255 x Ø42 x 30 
			
05.020.1912.290 Lenkstange Drag Rod	000 460 66 05 19929 01	MK, NG, SK	1130 x Ø40 x 32 
			

ST-Artikel ST-Article	Vergleichs-Nr. Comparison No.	passend für to fit to	Details Details
05.020.1912.520 Lenkstange Drag Rod 	676 460 31 05 24231 01	LK/LN2	783 x Ø42 x 26 
 Ersatzteil bzw. Rep.Satz spare part or rep.-kit	05.030.1907.209, Kugelgelenk Ball Joint		
05.020.1912.640 Lenkstange Drag Rod 	970 460 08 05 970 460 10 05 24240 01	Atego, Atego 2	846 x Ø42 x 26 
 Ersatzteil bzw. Rep.Satz spare part or rep.-kit	05.030.1907.209, Kugelgelenk Ball Joint		
05.020.1912.740 Lenkstange Drag Rod 	001 460 98 05 001 460 99 05 23469 01	Actros, Actros MP2 / MP3	866 x Ø38 x 30 
 Ersatzteil bzw. Rep.Satz spare part or rep.-kit	05.030.0907.029, Kugelgelenk Ball Joint		
05.020.1912.810 Lenkstange Drag Rod 	002 460 76 05 002 460 75 05 31150 01	Atego, Axor 2	886 x Ø38 x 30 
 Ersatzteil bzw. Rep.Satz spare part or rep.-kit	05.030.0907.029, Kugelgelenk Ball Joint		

ST-Artikel ST-Article	Vergleichs-Nr. Comparison No.	passend für to fit to	Details Details
05.020.1912.860 Lenkstange Drag Rod 	002 460 62 05 002 460 61 05 25361 01	Actros, Actros MP2 / MP3, Atego, Axor 2	958 x Ø38 x 32 
 Ersatzteil bzw. Rep.Satz spare part or rep.-kit	05.030.1910.700, Kugelgelenk Ball Joint		
05.020.1913.210 Lenkstange Drag Rod 	002 460 86 05 002 460 87 05 25500 01	Actros, Actros MP2 / MP3	883 x Ø38 x 32 
 Ersatzteil bzw. Rep.Satz spare part or rep.-kit	05.030.1910.700, Kugelgelenk Ball Joint		
05.020.1913.220 Lenkstange Drag Rod 	002 460 06 05 24307 01	Actros, Actros MP2 / MP3	708 x Ø40 x 32 
05.020.1913.240 Lenkstange Drag Rod 	002 460 92 05 002 460 93 05 31149 01	Actros, Actros MP2 / MP3	953 x Ø42 x 32 
 Ersatzteil bzw. Rep.Satz spare part or rep.-kit	05.030.1910.700, Kugelgelenk Ball Joint		

ST-Artikel ST-Article	Vergleichs-Nr. Comparison No.	passend für to fit to	Details Details
05.020.1913.250 Lenkstange Drag Rod 	003 460 60 05 972 460 19 05 26021 01	Atego, Atego 2	894 x Ø50 x 30 
<i>i</i>	Ersatzteil bzw. Rep.Satz spare part or rep.-kit	05.030.0907.029, Kugelgelenk Ball Joint	
05.020.1913.260 Lenkstange Drag Rod 	001 460 15 05 001 460 73 05 29799 01	Actros, Actros MP2 / MP3, Axor 2	733 x Ø36 x 32 
<i>i</i>	Ersatzteil bzw. Rep.Satz spare part or rep.-kit	05.030.1910.440, Kugelgelenk Ball Joint 05.030.1910.700, Kugelgelenk Ball Joint	
05.020.1913.280 Lenkstange Drag Rod 	970 460 11 05 972 460 28 05 21673 01	Atego, Atego 2	846 x Ø42 x 26 
<i>i</i>	Ersatzteil bzw. Rep.Satz spare part or rep.-kit	05.030.1907.209, Kugelgelenk Ball Joint	
05.020.1913.290 Lenkstange Drag Rod 	974 460 05 05 974 460 09 05 24195 01	Atego, Atego 2	884 x Ø50 x 30 
<i>i</i>	Ersatzteil bzw. Rep.Satz spare part or rep.-kit	05.030.0907.029, Kugelgelenk Ball Joint	

ST-Artikel ST-Article	Vergleichs-Nr. Comparison No.	passend für to fit to	Details Details
05.020.1913.300 Lenkstange Drag Rod 	001 460 49 05 001 460 74 05 24201 01	Actros, Actros MP2 / MP3	893 x Ø42 x 32 
 Ersatzteil bzw. Rep.Satz spare part or rep.-kit	05.030.1910.700, Kugelgelenk Ball Joint		
05.020.1913.330 Lenkstange Drag Rod 	002 460 24 05 002 460 30 05 24313 01	Atego	927 x Ø50 x 30 
 Ersatzteil bzw. Rep.Satz spare part or rep.-kit	05.030.0907.029, Kugelgelenk Ball Joint		
05.020.1913.340 Lenkstange Drag Rod 	002 460 25 05 002 460 31 05 24314 01	Atego	743 x Ø42 x 30 
05.020.1913.350 Lenkstange Drag Rod 	002 460 53 05 002 460 54 05 24316 01	Atego, Axor 2	905 x Ø38 x 32 
 Ersatzteil bzw. Rep.Satz spare part or rep.-kit	05.030.1910.700, Kugelgelenk Ball Joint		

ST-Artikel ST-Article	Vergleichs-Nr. Comparison No.	passend für to fit to	Details Details
05.020.1913.360 Lenkstange Drag Rod 	972 460 06 05 26020 01	Atego, Atego 2	875 x Ø50 x 30 
 Ersatzteil bzw. Rep.Satz spare part or rep.-kit	05.030.0907.029, Kugelgelenk Ball Joint		
05.020.1913.370 Lenkstange Drag Rod 	974 460 00 05 974 460 06 05 26023 01	Atego, Atego 2	875 x Ø50 x 30 
 Ersatzteil bzw. Rep.Satz spare part or rep.-kit	05.030.0907.029, Kugelgelenk Ball Joint		
05.020.1913.380 Lenkstange Drag Rod 	974 460 15 05 24198 01	Atego, Atego 2	888 x Ø50 x 30 
 Ersatzteil bzw. Rep.Satz spare part or rep.-kit	05.030.0907.029, Kugelgelenk Ball Joint		
05.020.1913.390 Lenkstange Drag Rod 	002 460 88 05 002 460 89 05 25499 01	Actros, Actros MP2 / MP3, Axor 2	716 x Ø38 x 32 
 Ersatzteil bzw. Rep.Satz spare part or rep.-kit	05.030.1910.700, Kugelgelenk Ball Joint		

ST-Artikel ST-Article	Vergleichs-Nr. Comparison No.	passend für to fit to	Details Details
05.020.1913.400 Lenkstange Drag Rod 	003 460 18 05 003 460 19 05 35331 01	Actros MP2 / MP3	888 x Ø42 x 28,6 
 Ersatzteil bzw. Rep.Satz spare part or rep.-kit	05.030.1912.610, Kugelgelenk Ball Joint		
05.020.1913.410 Lenkstange Drag Rod 	976 460 04 05 35806 01 26026 01	Atego, Atego 2	895 x Ø50 x 30 
 Ersatzteil bzw. Rep.Satz spare part or rep.-kit	05.030.0907.029, Kugelgelenk Ball Joint		
05.020.1980.990 Lenkstange Drag Rod 	972 460 14 05 972 460 16 05 24241 01	Atego, Atego 2	837 x Ø40 x 26 
 Ersatzteil bzw. Rep.Satz spare part or rep.-kit	05.030.1907.209, Kugelgelenk Ball Joint		
05.030.0280.112 Kugelgelenk Ball Joint 	000 463 26 29 000 463 23 29 22536 01	MB-Trac	90 x 26 / M22 x 1,5 

ST-Artikel ST-Article	Vergleichs-Nr. Comparison No.	passend für to fit to	Details Details
05.030.0280.210 Kugelgelenk Ball Joint 	624 460 03 48 18461 01 31708 01	NG, SK	85 x 38 / M26 x 1,5 
05.030.0906.610 Kugelgelenk Ball Joint 	699 460 16 48 11572 01	SK	160 x 30 / M30 x 1,5 
05.030.0907.019 Kugelgelenk Ball Joint 	001 460 36 48 002 460 03 48 11492 03 11492 02 11390 01	Actros, Actros MP2 / MP3, Atego, Atego 2	125 x 30 / M30 x 1,5 
i Ersatzteil bzw. Rep.Satz spare part or rep.-kit	05.010.0280.900, Spurstange Tie Rod 05.010.0803.630, Spurstange Tie Rod 05.010.0994.510, Spurstange Tie Rod 05.010.1913.460, Spurstange Tie Rod 05.010.4007.067, Spurstange Tie Rod 05.010.4007.068, Spurstange Tie Rod 05.010.4256.320, Spurstange Tie Rod 05.010.4256.330, Spurstange Tie Rod 05.010.4256.350, Spurstange Tie Rod 05.020.0280.820, Lenkstange Drag Rod 05.020.0280.830, Lenkstange Drag Rod 05.020.0994.110, Lenkstange Drag Rod 05.020.0994.120, Lenkstange Drag Rod 05.020.0994.160, Lenkstange Drag Rod 05.020.0994.260, Lenkstange Drag Rod 05.020.0994.280, Lenkstange Drag Rod	Komplementärteil complementary part	05.030.0907.029, Kugelgelenk Ball Joint

05.030.0907.029

Kugelgelenk
Ball Joint



001 460 77 48
001 460 22 48

Actros, Actros MP2 / MP3, Atego,
Atego 2, NG, SK

125 x 30 / M30 x 1,5

11505 03
11505 02
11389 01



Ersatzteil bzw. Rep.Satz | spare
part or rep.-kit

05.010.0280.900, Spurstange | Tie Rod
05.010.0803.630, Spurstange | Tie Rod
05.010.0994.510, Spurstange | Tie Rod
05.010.0994.550, Spurstange | Tie Rod
05.010.1913.460, Spurstange | Tie Rod
05.010.1913.510, Spurstange | Tie Rod
05.010.4007.067, Spurstange | Tie Rod
05.010.4007.068, Spurstange | Tie Rod
05.010.4256.320, Spurstange | Tie Rod
05.010.4256.330, Spurstange | Tie Rod
05.010.4256.350, Spurstange | Tie Rod
05.020.0280.390, Lenkstange | Drag Rod
05.020.0280.830, Lenkstange | Drag Rod
05.020.0803.760, Lenkstange | Drag Rod
05.020.0803.770, Lenkstange | Drag Rod
05.020.0803.780, Lenkstange | Drag Rod
05.020.0994.110, Lenkstange | Drag Rod
05.020.0994.120, Lenkstange | Drag Rod
05.020.0994.160, Lenkstange | Drag Rod
05.020.0994.170, Lenkstange | Drag Rod
05.020.0994.190, Lenkstange | Drag Rod
05.020.0994.260, Lenkstange | Drag Rod
05.020.0994.280, Lenkstange | Drag Rod
05.020.1913.250, Lenkstange | Drag Rod
05.020.1913.290, Lenkstange | Drag Rod
05.020.1913.330, Lenkstange | Drag Rod
05.020.1913.360, Lenkstange | Drag Rod
05.020.1913.370, Lenkstange | Drag Rod
05.020.1913.380, Lenkstange | Drag Rod
05.020.1913.410, Lenkstange | Drag Rod
05.020.4256.370, Lenkstange | Drag Rod

Komplementärteil | complemen-
tary part

05.030.0907.019, Kugelgelenk | Ball Joint

05.030.0907.130

Kugelgelenk
Ball Joint



629 338 00 10
25353 01

Actros, Actros MP2 / MP3, Atego,
NG, SK

140 x 30 / M30 x 1,5



Ersatzteil bzw. Rep.Satz | spare
part or rep.-kit

05.010.0280.380, Spurstange | Tie Rod
05.010.0994.520, Spurstange | Tie Rod
05.010.3001.910, Spurstange | Tie Rod
05.020.0280.820, Lenkstange | Drag Rod
05.020.0994.140, Lenkstange | Drag Rod
05.020.0994.270, Lenkstange | Drag Rod

ST-Artikel ST-Article	Vergleichs-Nr. Comparison No.	passend für to fit to	Details Details
05.030.0993.730 Kugelgelenk Ball Joint 	000 460 49 48 000 463 46 29 19537 01 25064 01 19862 01	Actros, Actros MP2 / MP3, Atego, Atego 2, Axor 2, SK	95 x 30 / M26 x 1,5 
05.030.1907.120 Kugelgelenk Ball Joint 	000 330 93 35 000 330 14 35 11378 01	Atego, LK/LN2, MB-Trac, MK, NG, Unimog	101 x 22 / M28 x 1,5 
<i>i</i> Ersatzteil bzw. Rep.Satz spare part or rep.-kit Komplementärteil complemen- tary part	05.010.1913.480, Spurstange Tie Rod 05.020.0994.250, Lenkstange Drag Rod 05.030.1907.160, Kugelgelenk Ball Joint		
05.030.1907.150 Kugelgelenk Ball Joints 	001 330 03 35 001 330 04 35 11404 01	LK/LN2, LP, NG	115 x 22 / M30 x 1,5 
05.030.1907.160 Kugelgelenk Ball Joint 	000 330 94 35 000 330 96 35 11379 01	Atego, LK/LN2, MK, NG	101 x 22 / M28 xx 1,5 
<i>i</i> Komplementärteil complemen- tary part	05.030.1907.120, Kugelgelenk Ball Joint		

ST-Artikel ST-Article	Vergleichs-Nr. Comparison No.	passend für to fit to	Details Details
05.030.1907.170 Kugelgelenk Ball Joint	001 330 14 35 001 330 12 35 11407 01	LP	96 x 18 / M24 x 1,5
			
05.030.1907.180 Kugelgelenk Ball Joint	000 330 85 35 000 330 87 35 11376 02 11376 01 19667 01	LK/LN2, LP, NG	95 x 20 / M24 x 1,5
			
 Komplementärteil complemen- tary part	05.030.1907.190, Kugelgelenk Ball Joint		
05.030.1907.190 Kugelgelenk Ball Joint	000 330 86 35 000 330 88 35 11377 03 11377 01	LK/LN2, LP, NG	95 x 20 / M24 x 1,5
			
 Komplementärteil complemen- tary part	05.030.1907.180, Kugelgelenk Ball Joint		

ST-Artikel ST-Article	Vergleichs-Nr. Comparison No.	passend für to fit to	Details Details
--------------------------	----------------------------------	--------------------------	--------------------

05.030.1907.209

Kugelgelenk
Ball Joint



i Ersatzteil bzw. Rep.Satz | spare part or rep.-kit

Komplementärteil | complementary part

001 330 01 35
001 330 02 35

11402 01
25718 01
24570 01

05.010.1913.500, Spurstange | Tie Rod
05.020.0280.800, Lenkstange | Drag Rod
05.020.0994.560, Lenkstange | Drag Rod
05.020.0994.570, Lenkstange | Drag Rod
05.020.1913.280, Lenkstange | Drag Rod
05.020.4007.084, Lenkstange | Drag Rod
05.020.4007.085, Lenkstange | Drag Rod

05.030.1907.549, Kugelgelenk | Ball Joint

Actros, Atego, Atego 2, Axor,
Econic, LK/LN2, MB-Trac, NG,
SK, Unimog

120 x 26 / M30 x 1,5



05.030.1907.210

Kugelgelenk
Ball Joint



i Komplementärteil | complementary part

001 330 21 35
001 330 26 35

30904 01

05.030.1907.220, Kugelgelenk | Ball Joint

SK

150 x 26 / M35 x 1,5



05.030.1907.220

Kugelgelenk
Ball Joint



i Komplementärteil | complementary part

001 330 22 35
001 330 27 35

30905 01

05.030.1907.210, Kugelgelenk | Ball Joint

SK

150 x 26 / M35 x 1,5



ST-Artikel
ST-Article

Vergleichs-Nr.
Comparison No.

passend für
to fit to

Details
Details

05.030.1907.410

Kugelgelenk
Ball Joint



000 330 98 35
001 330 00 35

11381 01

Unimog

106 x 22 / M24 x 1,5



05.030.1907.549

Kugelgelenk
Ball Joint



302 330 02 35
302 330 03 35

11403 01
11728 01
19675 01

Atego, Atego 2, LK/LN2, NG, SK,
Unimog

120 x 26 / M30 x 1,5



Komplementärteil | complemen-
tary part

05.030.1907.209, Kugelgelenk | Ball Joint

05.030.1907.980

Kugelgelenk
Ball Joint



000 460 26 48
000 460 27 48

11388 01

LK/LN2, NG

125 x 26 / M30 x 1,5



05.030.1910.440

Kugelgelenk
Ball Joint



001 460 05 48
001 460 79 48

12280 04
12280 03

Actros, Actros MP2 / MP3, Arocs,
Atego, Atego 2, Axor 2, Econic,
NG, SK

125 x 32 / M30 x 1,5





Ersatzteil bzw. Rep.Satz | spare
part or rep.-kit



05.010.1913.430, Spurstange | Tie Rod
05.020.1913.260, Lenkstange | Drag Rod

Komplementärteil | complemen-
tary part

05.030.1910.700, Kugelgelenk | Ball Joint

ST-Artikel ST-Article	Vergleichs-Nr. Comparison No.	passend für to fit to	Details Details
<p>05.030.1910.700</p> <p>Kugelgelenk Ball Joint</p>  <p><i>i</i> Ersatzteil bzw. Rep.Satz spare part or rep.-kit</p> <p>Komplementärteil complementary part</p>	<p>001 460 76 48 001 460 17 48</p> <p>11394 04 11394 03</p> <p>05.010.1913.430, Spurstange Tie Rod 05.020.1913.210, Lenkstange Drag Rod 05.020.1913.240, Lenkstange Drag Rod 05.020.1913.260, Lenkstange Drag Rod 05.020.1913.300, Lenkstange Drag Rod 05.020.1913.350, Lenkstange Drag Rod 05.020.1913.390, Lenkstange Drag Rod 05.030.1910.440, Kugelgelenk Ball Joint</p>	<p>Actros, Actros MP2 / MP3, Arocs, Atego, Axor 2, Econic, MK, NG, SK, Unimog</p>	<p>125 x 32 / M30 x 1,5</p> 

<p>05.030.1910.880</p> <p>Kugelgelenk Ball Joint</p> 	<p>000 338 49 23</p> <p>19822 01</p>	<p>Unimog</p>	<p>100 x 18 / M22 x 1,5</p> 
--	--------------------------------------	---------------	---

<p>05.030.1910.890</p> <p>Kugelgelenk Ball Joint</p>  <p><i>i</i> Komplementärteil complementary part</p>	<p>631 330 04 35</p> <p>12838 01</p> <p>05.030.1980.900, Kugelgelenk Ball Joint</p>	<p>MB-Trac</p>	<p>100 x 20 / M20 x 1,5</p> 
--	---	----------------	---

ST-Artikel ST-Article	Vergleichs-Nr. Comparison No.	passend für to fit to	Details Details
05.030.1910.980 Kugelgelenk Ball Joint	000 460 17 48 19615 01	Actros, Actros MP2 / MP3, Atego, Axor 2, NG, SK	135 x 38 / M38 x 1,5 
	 Komplementärteil complemen- tary part	05.030.0610.330, Kugelgelenk Ball Joint	
05.030.1912.610 Kugelgelenk Ball Joint	001 460 51 48 001 460 86 48 27623 01	Actros, Actros MP2 / MP3, Actros MP4, Antos, Arocs, Atego, Axor, Axor 2, Unimog	115 x 28,6 / M30 x 1,5 
	 Ersatzteil bzw. Rep.Satz spare part or rep.-kit	05.010.4007.065, Spurstange Tie Rod 05.020.1911.460, Lenkstange Drag Rod 05.020.1913.400, Lenkstange Drag Rod 05.020.4007.077, Lenkstange Drag Rod	
05.030.1912.621 Kugelgelenk Ball Joint	001 460 85 48 001 460 42 48 23077 01	Actros, Actros MP2 / MP3, Atego, Axor, Axor 2	140 x 28,6 / M28 x 1,5 
			
05.030.1912.780 Kugelgelenk Ball Joint	001 460 15 48 001 460 16 48 33397 01	Actros, Actros MP2 / MP3, Axor 2, SK	75 x 32 / M26 x 1,5 
			

ST-Artikel ST-Article	Vergleichs-Nr. Comparison No.	passend für to fit to	Details Details
05.030.1980.840 Kugelgelenk Ball Joint 	631 338 03 10 12839 01	MB-Trac	92 x 18,2 / M18 x 1,5 
 Komplementärteil complemen- tary part	05.030.1980.850, Kugelgelenk Ball Joint		
05.030.1980.850 Kugelgelenk Ball Joint 	631 338 04 10 12840 01	MB-Trac	92 x 18,2 / M18 x 1,5 
 Komplementärteil complemen- tary part	05.030.1980.840, Kugelgelenk Ball Joint		
05.030.1980.860 Kugelgelenk Ball Joint 	000 330 97 35 000 330 12 35 11380 01 19674 01 11380 02	Unimog	106 x 22 / M24 x 1,5 
 Komplementärteil complemen- tary part	05.030.1907.410, Kugelgelenk Ball Joint		
05.030.1980.900 Kugelgelenk Ball Joint 	631 338 05 10 001 330 48 35	MB-Trac	100 x 20 / M20 x 1,5 
 Komplementärteil complemen- tary part	05.030.1910.890, Kugelgelenk Ball Joint		

ST-Artikel ST-Article	Vergleichs-Nr. Comparison No.	passend für to fit to	Details Details
05.030.1980.970 Kugelgelenk Ball Joint	001 330 18 35 000 340 12 07	NG, SK	125 x 30 / M38 x 1,5
			
05.030.1980.980 Kugelgelenk Ball Joint	000 463 25 29 000 463 24 29 14982 01	MB-Trac	75 x 26 / M22 x 1,5
			
05.030.3040.110 Kugelgelenk Ball Joint	000 460 52 48 21440 01 11393 01	Arocs	150 x 30 / M30 x 1,5
			
 Ersatzteil bzw. Rep.Satz spare part or rep.-kit	05.010.4256.360, Spurstange Tie Rod		
05.030.1980.770 Trag-/Führungsgelenk Ball Joint	631 320 02 28 631 320 00 28 11462 01	MB-Trac	103 x 22 / M16 x 1,5
			

ST-Artikel ST-Article	Vergleichs-Nr. Comparison No.	passend für to fit to	Details Details
05.050.1915.210 Ausgleichsbehälter, Hydrauliköl-Servo- lenkung Expansion Tank, power steering hyd- raulic oil 	000 466 62 03	Actros	
05.050.1915.030 Hydraulikpumpe, Lenkung Hydraulic Pump, Steering 	001 460 30 80 001 460 51 80 8695.955.147	Actros, Actros MP2 / MP3	M26x1,5 / M16x1,5 
05.050.1915.040 Hydraulikpumpe, Lenkung Hydraulic Pump, Steering 	001 460 44 80 001 460 75 80 7685.955.246	Atego, Atego 2, Axor, Axor 2, Econic, LK/LN2, Unimog	M26x1,5 / M16x1,5 
05.050.1915.050 Hydraulikpumpe, Lenkung Hydraulic Pump, Steering 	002 460 15 80 002 460 17 80 7685.955.253	Atego, Atego 2, Axor, Axor 2, Econic, Zetros	M26x1,5 / M16x1,5 

ST-Artikel
ST-Article

Vergleichs-Nr.
Comparison No.

passend für
to fit to

Details
Details

05.050.1915.060

Hydraulikpumpe, Lenkung
Hydraulic Pump, Steering



001 460 31 80
003 460 51 80
542 0048 10

Actros, Actros MP2 / MP3

M26x1,5 / M16x1,5



05.050.1915.070

Hydraulikpumpe, Lenkung
Hydraulic Pump, Steering



003 460 22 80
003 460 49 80
8695.955.149

Actros, Actros MP2 / MP3

M26x1,5 / M18x1,5



05.050.1915.080

Hydraulikpumpe, Lenkung
Hydraulic Pump, Steering



002 460 76 80
000 460 24 80
7684.955.198

LK/LN2, MK, NG, SK, Unimog

M26x1,5 / M16x1,5



05.050.1915.090

Hydraulikpumpe, Lenkung
Hydraulic Pump, Steering



000 460 94 80
001 460 42 80
7684.955.182

Atego, Atego 2, Axor 2

M26x1,5 / M18x1,5



ST-Artikel ST-Article	Vergleichs-Nr. Comparison No.	passend für to fit to	Details Details
05.050.1915.100 Hydraulikpumpe, Lenkung Hydraulic Pump, Steering	002 460 53 80 001 460 85 80 7685.955.247	Atego 2, Axor 2, Unimog	M26x1,5 / M16x1,5
			
05.050.1915.150 Hydraulikpumpe, Lenkung Hydraulic Pump, Steering	001 460 52 80 002 460 41 80 8696.955.112	Actros, Actros MP2 / MP3	M26x1,5 / M16x1,5
			
05.050.1915.170 Hydraulikpumpe, Lenkung Hydraulic Pump, Steering	003 460 03 80 003 460 52 80 542 0454 10	Actros, Actros MP2 / MP3	M26x1,5 / M18x1,5
			











passend für
to fit to

Renault Trucks

LKW
Truck







ST-Artikel ST-Article	Vergleichs-Nr. Comparison No.	passend für to fit to	Details Details
05.010.3040.160 Spurstange Tie Rod 	5000 613 598 19866 01 19866 02 27574 02	Midlum	1736 x Ø40 x 30 
 Ersatzteil bzw. Rep.Satz spare part or rep.-kit	05.030.0907.019, Kugelgelenk Ball Joint 05.030.0907.029, Kugelgelenk Ball Joint		
05.010.4007.068 Spurstange Tie Rod 	5010 566 051 34696 01	Midlum	1580 x Ø40 x 30 
 Ersatzteil bzw. Rep.Satz spare part or rep.-kit	05.030.0907.019, Kugelgelenk Ball Joint 05.030.0907.029, Kugelgelenk Ball Joint		
05.010.4251.501 Spurstange Tie Rod 	5010 587 004 5010 600 822 37228 01 33574 01	C-Serie, Magnum Dxi, Premium 2	1726 x Ø52 x 30 
 Ersatzteil bzw. Rep.Satz spare part or rep.-kit	05.030.3040.110, Kugelgelenk Ball Joint		
05.010.4256.131 Spurstange Tie Rod 	5001 868 367 7421 560 968 33577 01	C-Serie, Premium 2	1676 x Ø40 x 30 
 Ersatzteil bzw. Rep.Satz spare part or rep.-kit	05.030.0907.019, Kugelgelenk Ball Joint 05.030.0907.029, Kugelgelenk Ball Joint		

ST-Artikel ST-Article	Vergleichs-Nr. Comparison No.	passend für to fit to	Details Details
05.010.4256.132 Spurstange Tie Rod 	5010 587 049 5010 587 052 33576 01	C-Serie, Premium 2	1719 x Ø40 x 30 
<i>i</i> Ersatzteil bzw. Rep.Satz spare part or rep.-kit	05.030.0907.019, Kugelgelenk Ball Joint 05.030.0907.029, Kugelgelenk Ball Joint		
05.010.4256.133 Spurstange Tie Rod 	5001 868 366 5010 587 034 37229 01 33575 01	C-Serie, Premium 2	1686 x Ø60 x 30 
<i>i</i> Ersatzteil bzw. Rep.Satz spare part or rep.-kit	05.030.3040.110, Kugelgelenk Ball Joint		
05.010.4256.310 Spurstange Tie Rod 	5010 439 021 5010 566 063 29454 01	Magnum AE, Magnum E-Tech, Premium	1758 x Ø52 x 30 
<i>i</i> Ersatzteil bzw. Rep.Satz spare part or rep.-kit	05.030.3040.110, Kugelgelenk Ball Joint		
05.010.4256.320 Spurstange Tie Rod 	5001 869 828 5010 308 082 27456 02	Kerax, Premium	1720 x Ø48 x 30 
<i>i</i> Ersatzteil bzw. Rep.Satz spare part or rep.-kit	05.030.0907.019, Kugelgelenk Ball Joint 05.030.0907.029, Kugelgelenk Ball Joint		

ST-Artikel ST-Article	Vergleichs-Nr. Comparison No.	passend für to fit to	Details Details
05.010.4256.330 Spurstange Tie Rod 	5010 566 058 29438 01	Kerax, Magnum AE, Midlum, Premium 2	1650 x Ø40 x 30 
 Ersatzteil bzw. Rep.Satz spare part or rep.-kit	05.030.0907.019, Kugelgelenk Ball Joint 05.030.0907.029, Kugelgelenk Ball Joint		
05.010.4256.340 Spurstange Tie Rod 	5010 630 434 37233 01 35594 01	Magnum Dxi, Premium 2	1818 x Ø58 x 30 
05.010.4256.350 Spurstange Tie Rod 	5001 869 829 5010 439 631 29453 01 29950 01 29451 01	G, Kerax, Major, Maxter, Premium	1752 x Ø48 x 30 
 Ersatzteil bzw. Rep.Satz spare part or rep.-kit	05.030.0907.019, Kugelgelenk Ball Joint 05.030.0907.029, Kugelgelenk Ball Joint		
05.010.4256.360 Spurstange Tie Rod 	5010 439 022 5010 566 064 29954 01	Premium	1720 x Ø52 x 30 
 Ersatzteil bzw. Rep.Satz spare part or rep.-kit	05.030.3040.110, Kugelgelenk Ball Joint		

ST-Artikel ST-Article	Vergleichs-Nr. Comparison No.	passend für to fit to	Details Details
05.020.4002.242 Lenkstange Drag Rod 	5010 647 033 5010 647 032 33583 01	Premium 2	825 x Ø62 x 30 
05.020.4007.084 Lenkstange Drag Rod 	5010 488 167 25720 02 25720 01	Midlum	946 x Ø42 x 26 
 Ersatzteil bzw. Rep.Satz spare part or rep.-kit	05.030.1907.209, Kugelgelenk Ball Joint		
05.020.4007.085 Lenkstange Drag Rod 	5010 305 365 5010 630 255 35593 01	Midlum	922 x Ø42 x 26 
 Ersatzteil bzw. Rep.Satz spare part or rep.-kit	05.030.1907.209, Kugelgelenk Ball Joint		
05.020.4251.500 Lenkstange Drag Rod 	5010 130 344 18990 02 18990 01	Magnum AE	765 x Ø52 x 30 
 Ersatzteil bzw. Rep.Satz spare part or rep.-kit	05.030.0907.029, Kugelgelenk Ball Joint		

ST-Artikel ST-Article	Vergleichs-Nr. Comparison No.	passend für to fit to	Details Details
05.020.4251.530 Lenkstange Drag Rod 	5010 294 287 24590 01	Premium	810 x Ø50 x 30 
 Ersatzteil bzw. Rep.Satz spare part or rep.-kit	05.030.0907.029, Kugelgelenk Ball Joint		
05.020.4251.540 Lenkstange Drag Rod 	5010 630 617 5010 294 289 37237 01	Premium	870 x Ø62 x 30 
 Ersatzteil bzw. Rep.Satz spare part or rep.-kit	05.030.0907.029, Kugelgelenk Ball Joint		
05.020.4251.550 Lenkstange Drag Rod 	5010 294 288 24592 01	Premium	845 x Ø52 x 30 
 Ersatzteil bzw. Rep.Satz spare part or rep.-kit	05.030.0907.029, Kugelgelenk Ball Joint		
05.020.4256.000 Lenkstange Drag Rod 	5010 557 243 5010 060 764 19857 01	Magnum AE, Magnum E-Tech	720 x Ø40 x 30 
 Ersatzteil bzw. Rep.Satz spare part or rep.-kit	05.030.0907.029, Kugelgelenk Ball Joint		

ST-Artikel ST-Article	Vergleichs-Nr. Comparison No.	passend für to fit to	Details Details
05.020.4256.001 Lenkstange Drag Rod 	7421 560 825 5010 630 637 33578 01	Magnum Dxi	700 x Ø50 x 30 
05.020.4256.190 Lenkstange Drag Rod 	5010 557 523 5010 383 203 27677 01	Magnum E-Tech	735 x Ø50 x 30 
 Ersatzteil bzw. Rep.Satz spare part or rep.-kit	05.030.0907.029, Kugelgelenk Ball Joint		
05.020.4256.370 Lenkstange Drag Rod 	5010 294 720 27477 02	Premium	827 x Ø52 x 30 
 Ersatzteil bzw. Rep.Satz spare part or rep.-kit	05.030.0907.029, Kugelgelenk Ball Joint		
05.030.0803.430 Kugelgelenk Ball Joint 	5001 823 718 25073 01	Kerax, Maxter	86 x 38 / M30 x 1,5 

ST-Artikel
ST-Article

Vergleichs-Nr.
Comparison No.

passend für
to fit to

Details
Details

05.030.0907.019

Kugelgelenk
Ball Joint



5001 832 581
5000 288 361

11492 03
11492 02
11390 01

G, Kerax, Magnum AE, Manager,
Maxter, Midliner, Premium, R

125 x 30 / M30 x 1,5



Ersatzteil bzw. Rep.Satz | spare
part or rep.-kit

05.010.0280.900, Spurstange | Tie Rod
05.010.0803.630, Spurstange | Tie Rod
05.010.0994.510, Spurstange | Tie Rod
05.010.1913.460, Spurstange | Tie Rod
05.010.4007.067, Spurstange | Tie Rod
05.010.4007.068, Spurstange | Tie Rod
05.010.4256.320, Spurstange | Tie Rod
05.010.4256.330, Spurstange | Tie Rod
05.010.4256.350, Spurstange | Tie Rod
05.020.0280.820, Lenkstange | Drag Rod
05.020.0280.830, Lenkstange | Drag Rod
05.020.0994.110, Lenkstange | Drag Rod
05.020.0994.120, Lenkstange | Drag Rod
05.020.0994.160, Lenkstange | Drag Rod
05.020.0994.260, Lenkstange | Drag Rod
05.020.0994.280, Lenkstange | Drag Rod

Komplementärteil | complemen-
tary part

05.030.0907.029, Kugelgelenk | Ball Joint

05.030.0907.029

Kugelgelenk
Ball Joint



5000 288 360
5001 836 298

11505 03
11505 02
11389 01

G, Kerax, Magnum AE, Manager,
Maxter, Midliner, Midlum, Premi-
um, Premium 2, R

125 x 30 / M30 x 1,5



i Ersatzteil bzw. Rep.Satz | spare
part or rep.-kit

05.010.0280.900, Spurstange | Tie Rod
05.010.0803.630, Spurstange | Tie Rod
05.010.0994.510, Spurstange | Tie Rod
05.010.0994.550, Spurstange | Tie Rod
05.010.1913.460, Spurstange | Tie Rod
05.010.1913.510, Spurstange | Tie Rod
05.010.4007.067, Spurstange | Tie Rod
05.010.4007.068, Spurstange | Tie Rod
05.010.4256.320, Spurstange | Tie Rod
05.010.4256.330, Spurstange | Tie Rod
05.010.4256.350, Spurstange | Tie Rod
05.020.0280.390, Lenkstange | Drag Rod
05.020.0280.830, Lenkstange | Drag Rod
05.020.0803.760, Lenkstange | Drag Rod
05.020.0803.770, Lenkstange | Drag Rod
05.020.0803.780, Lenkstange | Drag Rod
05.020.0994.110, Lenkstange | Drag Rod
05.020.0994.120, Lenkstange | Drag Rod
05.020.0994.160, Lenkstange | Drag Rod
05.020.0994.170, Lenkstange | Drag Rod
05.020.0994.190, Lenkstange | Drag Rod
05.020.0994.260, Lenkstange | Drag Rod
05.020.0994.280, Lenkstange | Drag Rod
05.020.1913.250, Lenkstange | Drag Rod
05.020.1913.290, Lenkstange | Drag Rod
05.020.1913.330, Lenkstange | Drag Rod
05.020.1913.360, Lenkstange | Drag Rod
05.020.1913.370, Lenkstange | Drag Rod
05.020.1913.380, Lenkstange | Drag Rod
05.020.1913.410, Lenkstange | Drag Rod
05.020.4256.370, Lenkstange | Drag Rod

Komplementärteil | complemen-
tary part

05.030.0907.019, Kugelgelenk | Ball Joint

05.030.0907.130

Kugelgelenk
Ball Joint



7420 937 674
25353 01

C, Kerax, Magnum AE, Major, Ma-
nager, Maxter, Midliner, Midlum,
Premium, Premium 2, R



140 x 30 / M30 x 1,5







i Ersatzteil bzw. Rep.Satz | spare
part or rep.-kit



05.010.0280.380, Spurstange | Tie Rod
05.010.0994.520, Spurstange | Tie Rod
05.010.3001.910, Spurstange | Tie Rod
05.020.0280.820, Lenkstange | Drag Rod
05.020.0994.140, Lenkstange | Drag Rod
05.020.0994.270, Lenkstange | Drag Rod



ST-Artikel ST-Article	Vergleichs-Nr. Comparison No.	passend für to fit to	Details Details
05.030.1907.120 Kugelgelenk Ball Joint 	5001 861 924 0003 406 242 11378 01	Midliner, Midlum	101 x 22 / M28 x 1,5 
<i>i</i> Ersatzteil bzw. Rep.Satz spare part or rep.-kit Komplementärteil complementary part	05.010.1913.480, Spurstange Tie Rod 05.020.0994.250, Lenkstange Drag Rod 05.030.1907.160, Kugelgelenk Ball Joint		

05.030.1907.180 Kugelgelenk Ball Joint 	5001 844 136 5000 814 097 11376 02 11376 01 19667 01	Midliner	95 x 20 / M24 x 1,5 
<i>i</i> Komplementärteil complementary part	05.030.1907.190, Kugelgelenk Ball Joint		

05.030.1907.190 Kugelgelenk Ball Joint 	5001 844 135 5000 807 553 11377 03 11377 01	Manager, Midliner	95 x 20 / M24 x 1,5 
<i>i</i> Komplementärteil complementary part	05.030.1907.180, Kugelgelenk Ball Joint		

ST-Artikel ST-Article	Vergleichs-Nr. Comparison No.	passend für to fit to	Details Details
05.030.1907.209 Kugelgelenk Ball Joint 	5000 295 214 5000 812 483 11402 01 25718 01 24570 01	Magnum AE, Midliner, Midlum	120 x 26 / M30 x 1,5 
<i>i</i> Ersatzteil bzw. Rep.Satz spare part or rep.-kit Komplementärteil complementary part	05.010.1913.500, Spurstange Tie Rod 05.020.0280.800, Lenkstange Drag Rod 05.020.0994.560, Lenkstange Drag Rod 05.020.0994.570, Lenkstange Drag Rod 05.020.1913.280, Lenkstange Drag Rod 05.020.4007.084, Lenkstange Drag Rod 05.020.4007.085, Lenkstange Drag Rod 05.030.1907.549, Kugelgelenk Ball Joint		

05.030.1907.549 Kugelgelenk Ball Joint 	5001 134 533 5000 295 336 11403 01 11728 01 19675 01	Magnum AE, Midliner, Midlum	120 x 26 / M30 x 1,5 
<i>i</i> Komplementärteil complementary part	05.030.1907.209, Kugelgelenk Ball Joint		

05.030.1907.980 Kugelgelenk Ball Joint 	5000 808 458 7701 002 911 11388 01	Midliner	125 x 26 / M30 x 1,5 
---	--	----------	---

ST-Artikel ST-Article	Vergleichs-Nr. Comparison No.	passend für to fit to	Details Details
05.030.1912.780 Kugelgelenk Ball Joint 	5001 830 480 5001 845 430 33397 01	Kerax	75 x 32 / M26 x 1,5 
05.030.1980.970 Kugelgelenk Ball Joint 	5001 832 580 5001 831 481	Manager, Maxter, Midlum, R	125 x 30 / M38 x 1,5 
05.030.3040.110 Kugelgelenk Ball Joint 	5001 852 452 5001 858 763 21440 01 11393 01	Magnum E-Tech, Premium, Premium 2	150 x 30 / M30 x 1,5 
 Ersatzteil bzw. Rep.Satz spare part or rep.-kit	05.010.4256.360, Spurstange Tie Rod		
05.030.4007.042 Kugelgelenk Ball Joint 	7403 193 731 28792 01	Premium 2	120 x 28,8 / M26 x 1,5 



ST-Artikel
ST-Article

Vergleichs-Nr.
Comparison No.

passend für
to fit to

Details
Details

05.030.4007.046

7403 987 648

Premium 2













88 x 28,6 / M26 x 1,5

Kugelgelenk
Ball Joint

27634 01



passend für
to fit to
Scania
LKW
Truck

ST-Artikel ST-Article	Vergleichs-Nr. Comparison No.	passend für to fit to	Details Details
05.010.3001.120 Spurstange Tie Rod 	1 897 335 1 737 683 37247 01 22083 01 21010 01	P,G,R,T - Serie	1743 x Ø50 x 30 
 Ersatzteil bzw. Rep.Satz spare part or rep.-kit	05.030.0907.130, Kugelgelenk Ball Joint		
05.010.3001.620 Spurstange Tie Rod 	1 897 333 1 734 019 37547 01 23495 01 23495 02	P,G,R,T - Serie, 4 - Serie	1743 x Ø62 x 30 
 Ersatzteil bzw. Rep.Satz spare part or rep.-kit	05.030.3040.110, Kugelgelenk Ball Joint		
05.010.3001.910 Spurstange Tie Rod 	1 388 958 1 734 021 23316 01	P,G,R,T - Serie, 4 - Serie	1625 x Ø60 x 30 
 Ersatzteil bzw. Rep.Satz spare part or rep.-kit	05.030.0907.130, Kugelgelenk Ball Joint		
05.010.3001.920 Spurstange Tie Rod 	2 125 091 2 146 104 37546 01 31883 01	P,G,R,T - Serie	1743 x Ø52 x 30 
 Ersatzteil bzw. Rep.Satz spare part or rep.-kit	05.030.0993.860, Kugelgelenk Ball Joint 05.030.1910.700, Kugelgelenk Ball Joint		

ST-Artikel ST-Article	Vergleichs-Nr. Comparison No.	passend für to fit to	Details Details
05.010.3040.160 Spurstange Tie Rod 	2 028 998 1 734 020 19866 01 19866 02 27574 02	P,G,R,T - Serie, 4 - Serie	1736 x Ø40 x 30 
 Ersatzteil bzw. Rep.Satz spare part or rep.-kit	05.030.0907.019, Kugelgelenk Ball Joint 05.030.0907.029, Kugelgelenk Ball Joint		
05.020.3001.131 Lenkstange Drag Rod 	1 788 520 1 393 383 21448 01	P,G,R,T - Serie, 4 - Serie	1950 x Ø62 x 30 
05.020.3001.132 Lenkstange Drag Rod 	1 386 620 23500 01	P,G,R,T - Serie, 4 - Serie	1776 x Ø62 x 30 
05.020.3001.150 Lenkstange Drag Rod 	390 784 11932 01	3 - Serie	855 x Ø42 x 30 
 Ersatzteil bzw. Rep.Satz spare part or rep.-kit	05.030.0907.029, Kugelgelenk Ball Joint		

ST-Artikel ST-Article	Vergleichs-Nr. Comparison No.	passend für to fit to	Details Details
05.020.3001.190 Lenkstange Drag Rod 	278 665 278 666 11928 01	2 - Serie, 3 - Serie	940 x Ø46 x 30 
 Ersatzteil bzw. Rep.Satz spare part or rep.-kit	05.030.0907.029, Kugelgelenk Ball Joint		
05.020.3001.650 Lenkstange Drag Rod 	1 394 884 25139 02 25139 01	P,G,R,T - Serie, 4 - Serie	433 x Ø40 x 30 
 Ersatzteil bzw. Rep.Satz spare part or rep.-kit	05.030.0907.029, Kugelgelenk Ball Joint		
05.020.3040.000 Lenkstange Drag Rod 	1 912 757 1 847 311 14824 02	P,G,R,T - Serie, 4 - Serie	1060 x Ø52 x 30 
 Ersatzteil bzw. Rep.Satz spare part or rep.-kit	05.030.0907.029, Kugelgelenk Ball Joint		
05.020.3040.010 Lenkstange Drag Rod 	1 912 758 1 847 312 21009 02	P,G,R,T - Serie, 4 - Serie	1060 x Ø52 x 30 
 Ersatzteil bzw. Rep.Satz spare part or rep.-kit	05.030.0907.029, Kugelgelenk Ball Joint		

ST-Artikel ST-Article	Vergleichs-Nr. Comparison No.	passend für to fit to	Details Details
05.020.3040.040 Lenkstange Drag Rod 	1 343 262 25074 02 25074 01	P,G,R,T - Serie, 4 - Serie	603 x Ø42 x 26 
05.020.3040.060 Lenkstange Drag Rod 	1 759 690 1 343 266 21456 01	P,G,R,T - Serie, 4 - Serie	495 x Ø40 x 30 
 Ersatzteil bzw. Rep.Satz spare part or rep.-kit	05.030.0907.019, Kugelgelenk Ball Joint 05.030.0907.029, Kugelgelenk Ball Joint		
05.020.3040.120 Lenkstange Drag Rod 	1 759 691 1 343 283 21455 01	P,G,R,T - Serie, 4 - Serie	435 x Ø38 x 30 
 Ersatzteil bzw. Rep.Satz spare part or rep.-kit	05.030.0907.019, Kugelgelenk Ball Joint 05.030.3040.110, Kugelgelenk Ball Joint		
05.020.3040.130 Lenkstange Drag Rod 	2 007 278 1 732 635 23493 01	P,G,R,T - Serie, 4 - Serie	1920 x Ø62 x 30 



passend für | to fit to Scania

ST-Artikel
ST-Article

Vergleichs-Nr.
Comparison No.

passend für
to fit to

Details
Details

05.020.3040.140

Lenkstange
Drag Rod



2 007 274
1 343 278

23494 01

P,G,R,T - Serie, 4 - Serie

2783 x Ø62 x 30



05.020.3040.530

Lenkstange
Drag Rod



1 386 618
1 788 522

23502 01

P,G,R,T - Serie, 4 - Serie

2179 x Ø62 x 30



05.020.3040.550

Lenkstange
Drag Rod



1 385 764
1 765 376

23505 01

P,G,R,T - Serie, 4 - Serie

1606 x Ø38 x 30



ST-Artikel ST-Article	Vergleichs-Nr. Comparison No.	passend für to fit to	Details Details
05.020.3040.560 Lenkstange Drag Rod 	1 385 765 1 765 377 23506 01	P,G,R,T - Serie, 4 - Serie	1806 x Ø38 x 30 
05.020.3040.570 Lenkstange Drag Rod 	1 385 766 1 765 378 23507 01	P,G,R,T - Serie, 4 - Serie	2006 x Ø38 x 30 
05.020.3040.580 Lenkstange Drag Rod 	1 511 600 1 759 692 29389 01	P,G,R,T - Serie, 4 - Serie	2179 x Ø60 x 30 
05.020.3040.590 Lenkstange Drag Rod 	1 399 758 1 765 380 29391 01	P,G,R,T - Serie, 4 - Serie	1406 x Ø38 x 30 

ST-Artikel ST-Article	Vergleichs-Nr. Comparison No.	passend für to fit to	Details Details
05.020.3040.600 Lenkstange Drag Rod 	1 421 981 1 765 382 35441 01	P,G,R,T - Serie, 4 - Serie	1920 x Ø62 x 30 
05.020.3040.610 Lenkstange Drag Rod 	1 385 763 1 765 375 23504 01	P,G,R,T - Serie, 4 - Serie	1206 x Ø38 x 30 
05.020.3040.620 Lenkstange Drag Rod 	1 399 757 1 765 379 29390 01	P,G,R,T - Serie, 4 - Serie	1006 x Ø36 x 30 
05.020.3040.640 Lenkstange Drag Rod 	1 423 007 1 765 384 35306 01	P,G,R,T - Serie, 4 - Serie	2783 x Ø62 x 30 

ST-Artikel ST-Article	Vergleichs-Nr. Comparison No.	passend für to fit to	Details Details
05.020.3040.650 Lenkstange Drag Rod 	1 491 273 1 413 978 21444 01	4 - Serie	2783 x Ø62 x 30 
 Ersatzteil bzw. Rep.Satz spare part or rep.-kit	05.030.0907.130, Kugelgelenk Ball Joint		
05.020.3040.670 Lenkstange Drag Rod 	1 733 471 1 747 467 36655 01	P,G,R,T - Serie, 4 - Serie	1921 x Ø60 x 30 
05.030.0907.019 Kugelgelenk Ball Joint 	1 738 380 1 358 792 11492 03 11492 02 11390 01	P,G,R,T - Serie, 3 - Serie, 4 - Serie	125 x 30 / M30 x 1,5 
 Ersatzteil bzw. Rep.Satz spare part or rep.-kit	05.010.0280.900, Spurstange Tie Rod 05.010.0803.630, Spurstange Tie Rod 05.010.0994.510, Spurstange Tie Rod 05.010.1913.460, Spurstange Tie Rod 05.010.4007.067, Spurstange Tie Rod 05.010.4007.068, Spurstange Tie Rod 05.010.4256.320, Spurstange Tie Rod 05.010.4256.330, Spurstange Tie Rod 05.010.4256.350, Spurstange Tie Rod 05.020.0280.820, Lenkstange Drag Rod 05.020.0280.830, Lenkstange Drag Rod 05.020.0994.110, Lenkstange Drag Rod 05.020.0994.120, Lenkstange Drag Rod 05.020.0994.160, Lenkstange Drag Rod 05.020.0994.260, Lenkstange Drag Rod 05.020.0994.280, Lenkstange Drag Rod		
Komplementärteil complementary part	05.030.0907.029, Kugelgelenk Ball Joint		

05.030.0907.029

Kugelgelenk
Ball Joint



1 358 793

1 914 427

11505 03

11505 02

11389 01

P,G,R,T - Serie, 4 - Serie

125 x 30 / M30 x 1,5



05.010.0280.900, Spurstange | Tie Rod
05.010.0803.630, Spurstange | Tie Rod
05.010.0994.510, Spurstange | Tie Rod
05.010.0994.550, Spurstange | Tie Rod
05.010.1913.460, Spurstange | Tie Rod
05.010.1913.510, Spurstange | Tie Rod
05.010.4007.067, Spurstange | Tie Rod
05.010.4007.068, Spurstange | Tie Rod
05.010.4256.320, Spurstange | Tie Rod
05.010.4256.330, Spurstange | Tie Rod
05.010.4256.350, Spurstange | Tie Rod
05.020.0280.390, Lenkstange | Drag Rod
05.020.0280.830, Lenkstange | Drag Rod
05.020.0803.760, Lenkstange | Drag Rod
05.020.0803.770, Lenkstange | Drag Rod
05.020.0803.780, Lenkstange | Drag Rod
05.020.0994.110, Lenkstange | Drag Rod
05.020.0994.120, Lenkstange | Drag Rod
05.020.0994.160, Lenkstange | Drag Rod
05.020.0994.170, Lenkstange | Drag Rod
05.020.0994.190, Lenkstange | Drag Rod
05.020.0994.260, Lenkstange | Drag Rod
05.020.0994.280, Lenkstange | Drag Rod
05.020.1913.250, Lenkstange | Drag Rod
05.020.1913.290, Lenkstange | Drag Rod
05.020.1913.330, Lenkstange | Drag Rod
05.020.1913.360, Lenkstange | Drag Rod
05.020.1913.370, Lenkstange | Drag Rod
05.020.1913.380, Lenkstange | Drag Rod
05.020.1913.410, Lenkstange | Drag Rod
05.020.4256.370, Lenkstange | Drag Rod

i Ersatzteil bzw. Rep.Satz | spare part or rep.-kit

Komplementärteil | complementary part

05.030.0907.019, Kugelgelenk | Ball Joint

05.030.0907.130

Kugelgelenk
Ball Joint



1 534 756

1 358 793

25353 01

4 - Serie

140 x 30 / M30 x 1,5



05.010.0280.380, Spurstange | Tie Rod
05.010.0994.520, Spurstange | Tie Rod
05.010.3001.910, Spurstange | Tie Rod
05.020.0280.820, Lenkstange | Drag Rod
05.020.0994.140, Lenkstange | Drag Rod
05.020.0994.270, Lenkstange | Drag Rod

i Ersatzteil bzw. Rep.Satz | spare part or rep.-kit

ST-Artikel ST-Article	Vergleichs-Nr. Comparison No.	passend für to fit to	Details Details
05.030.0993.730 Kugelgelenk Ball Joint 	1 375 228 1 912 759 19537 01 25064 01 19862 01	P,G,R,T - Serie, 4 - Serie	95 x 30 / M26 x 1,5 
05.030.0993.860 Kugelgelenk Ball Joint 	1 723 897 2 051 041 27853 01	P,G,R,T - Serie	145 x 30 / M30 x 1,5 
 Ersatzteil bzw. Rep.Satz spare part or rep.-kit	05.010.0280.910, Spurstange Tie Rod 05.010.3001.920, Spurstange Tie Rod		
05.030.3001.210 Kugelgelenk Ball Joint 	310 980 539 413	3 - Serie	168 x 30 / M52 x 1,5 
05.030.3001.220 Kugelgelenk Ball Joint 	310 979	3 - Serie	168 x 30 / M52 x 1,5 

ST-Artikel ST-Article	Vergleichs-Nr. Comparison No.	passend für to fit to	Details Details
05.030.3040.110 Kugelgelenk Ball Joint 	1 738 379 1 357 674 21440 01 11393 01	P,G,R,T - Serie, 4 - Serie	150 x 30 / M30 x 1,5 
<p>i Ersatzteil bzw. Rep.Satz spare part or rep.-kit 05.010.4256.360, Spurstange Tie Rod</p>			
05.030.3040.510 Kugelgelenk Ball Joint 	1 394 447 34085 01	P,G,R,T - Serie, 4 - Serie	115 x 26 / M16 X 1,5 
05.050.3005.100 Hydraulikpumpe, Lenkung Hydraulic Pump, Steering 	1 333 790 1 422 417 542 0490 10 542 0013 10	P,G,R,T - Serie, 4 - Serie	M26x1,5 / M16x1,5 
05.050.3005.110 Hydraulikpumpe, Lenkung Hydraulic Pump, Steering 	1 308 495 1 457 708 542 0008 10	P,G,R,T - Serie, 3 - Serie, 4 - Serie	M26x1,5 / M16x1,5 

ST-Artikel
ST-Article

Vergleichs-Nr.
Comparison No.

passend für
to fit to

Details
Details

05.050.3005.120

Hydraulikpumpe, Lenkung
Hydraulic Pump, Steering



1 332 653
1 457 711

542 0012 10

P,G,R,T - Serie, 4 - Serie



05.050.3005.130

Hydraulikpumpe, Lenkung
Hydraulic Pump, Steering



1 324 223
1 421 273

542 0010 10

4 - Serie



05.050.3005.140

Hydraulikpumpe, Lenkung
Hydraulic Pump, Steering















1 504 006
1 371 404

P,G,R,T - Serie, 4 - Serie



passend für
to fit to
Volvo
LKW
Truck

ST-Artikel ST-Article	Vergleichs-Nr. Comparison No.	passend für to fit to	Details Details
05.010.1912.380 Spurstange Tie Rod 	20 830 369 3099 230 23996 01	FL 6	1605 x Ø40 x 30 
 Ersatzteil bzw. Rep.Satz spare part or rep.-kit	05.030.0907.019, Kugelgelenk Ball Joint 05.030.0907.029, Kugelgelenk Ball Joint		
05.010.4002.390 Spurstange Tie Rod 	3986 450 3988 711 22822 01 20581 01 23522 01	FH, FH 12, FH 16, FM 12, FM 7, FM 9, NH 12	1640 x Ø42 x 28,6 
 Ersatzteil bzw. Rep.Satz spare part or rep.-kit	05.030.4002.439, Kugelgelenk Ball Joint 05.030.4002.449, Kugelgelenk Ball Joint		
05.010.4007.011 Spurstange Tie Rod 	21 260 286 20 393 097 37222 01 22794 01 21479 01	F 12, F 16, FH 12, FH 16, FL 10, FL 12, FL 6, FL 7, FM 12, FM 7, FM 9	1640 x Ø58 x 28,6 
 Ersatzteil bzw. Rep.Satz spare part or rep.-kit	05.030.4004.840, Kugelgelenk Ball Joint		
05.010.4007.012 Spurstange Tie Rod 	3198 276 37223 01 27874 01	FH, FH 12, FH 16, FL 6, FM, FM 12, FM 9	1634 x Ø50 x 28,6 
 Ersatzteil bzw. Rep.Satz spare part or rep.-kit	05.030.4004.840, Kugelgelenk Ball Joint		

ST-Artikel ST-Article	Vergleichs-Nr. Comparison No.	passend für to fit to	Details Details
05.010.4007.013 Spurstange Tie Rod 	1626 494 19882 02 19882 01	F 10, F 12, F 16, F 7, FL 10, FL 12, FL 6, FL 7, FS 7, N 10, N 12, NL 10, NL 12	1592 x Ø42 x 28,6 
 Ersatzteil bzw. Rep.Satz spare part or rep.-kit	05.030.4002.439, Kugelgelenk Ball Joint 05.030.4002.449, Kugelgelenk Ball Joint		
05.010.4007.014 Spurstange Tie Rod 	1626 671 1599 175 19539 01	FL 10, FL 12	1779 x Ø60 x 31,5 
 Ersatzteil bzw. Rep.Satz spare part or rep.-kit	05.030.4002.480, Kugelgelenk Ball Joint		
05.010.4007.028 Spurstange Tie Rod 	8156 123 26064 01	FH 12, FH 16, FM 10, FM 12, FM 7	1674 x Ø42 x 28,6 
 Ersatzteil bzw. Rep.Satz spare part or rep.-kit	05.030.4002.439, Kugelgelenk Ball Joint 05.030.4002.449, Kugelgelenk Ball Joint		
05.010.4007.031 Spurstange Tie Rod 	85 115 641 20 361 568 29614 01	FL 6	1639 x Ø50 x 28,6 
 Ersatzteil bzw. Rep.Satz spare part or rep.-kit	05.030.4007.038, Kugelgelenk Ball Joint		

ST-Artikel ST-Article	Vergleichs-Nr. Comparison No.	passend für to fit to	Details Details
05.010.4007.061 Spurstange Tie Rod 	20 587 731 22 159 753 37227 01 31956 01	FH, FH II, FH 12, FH 16, FM, FM 12, FM 9	1660 x Ø60 x 32 
05.010.4007.062 Spurstange Tie Rod 	21 260 275 22 159 760 37224 01 27893 01	FH 12, FH 16, FM 12, FM 9	1660 x Ø60 x 28,6 
 Ersatzteil bzw. Rep.Satz spare part or rep.-kit	05.030.4004.840, Kugelgelenk Ball Joint		
05.010.4007.063 Spurstange Tie Rod 	20 581 086 34528 01	FH, FH 12, FH 16, FM, FM 12, FM 9	1669 x Ø42 x 32 
 Ersatzteil bzw. Rep.Satz spare part or rep.-kit	05.030.4002.420, Kugelgelenk Ball Joint 05.030.4007.043, Kugelgelenk Ball Joint		
05.010.4007.064 Spurstange Tie Rod 	20 399 543 22 159 769 37225 01 28791 01	FH 12, FH 16, FL 6, FM 12, FM 9	1818 x Ø52 x 28,6 
 Ersatzteil bzw. Rep.Satz spare part or rep.-kit	05.030.4007.038, Kugelgelenk Ball Joint		

ST-Artikel ST-Article	Vergleichs-Nr. Comparison No.	passend für to fit to	Details Details
05.010.4007.065 Spurstange Tie Rod 	1628 207 35333 01	FH, FH 12, FH 16, FM, FM 12, FM 9	368 x Ø38 x 28,6 
 Ersatzteil bzw. Rep.Satz spare part or rep.-kit	05.030.1912.610, Kugelgelenk Ball Joint		
05.010.4007.066 Spurstange Tie Rod 	20 383 080 22 159 758 37230 01 35532 01	FH, FH II, FH 12, FH 16, FH 16 II, FM, FM 12, FM 9, FMX	1025 x Ø48 x 28,6 
 Ersatzteil bzw. Rep.Satz spare part or rep.-kit	05.030.4007.038, Kugelgelenk Ball Joint		
05.010.4007.067 Spurstange Tie Rod 	20 742 117 1524 382 31539 01	FM, FM 12, FM 9, FMX	1528 x Ø42 x 30 
 Ersatzteil bzw. Rep.Satz spare part or rep.-kit	05.030.0907.019, Kugelgelenk Ball Joint 05.030.0907.029, Kugelgelenk Ball Joint		
05.010.4007.068 Spurstange Tie Rod 	20 582 399 22 482 972 34696 01	FL, FL III	1580 x Ø40 x 30 
 Ersatzteil bzw. Rep.Satz spare part or rep.-kit	05.030.0907.019, Kugelgelenk Ball Joint 05.030.0907.029, Kugelgelenk Ball Joint		

ST-Artikel ST-Article	Vergleichs-Nr. Comparison No.	passend für to fit to	Details Details
05.010.4251.501 Spurstange Tie Rod 	25 372 885 37228 01 33574 01	FE II	1726 x Ø52 x 30 
 Ersatzteil bzw. Rep.Satz spare part or rep.-kit	05.030.3040.110, Kugelgelenk Ball Joint		
05.010.4256.131 Spurstange Tie Rod 	21 560 968 25 370 845 33577 01	FE II	1676 x Ø40 x 30 
 Ersatzteil bzw. Rep.Satz spare part or rep.-kit	05.030.0907.019, Kugelgelenk Ball Joint 05.030.0907.029, Kugelgelenk Ball Joint		
05.010.4256.132 Spurstange Tie Rod 	25 370 844 21 560 965 33576 01	FE II	1719 x Ø40 x 30 
 Ersatzteil bzw. Rep.Satz spare part or rep.-kit	05.030.0907.019, Kugelgelenk Ball Joint 05.030.0907.029, Kugelgelenk Ball Joint		
05.010.4256.133 Spurstange Tie Rod 	22 163 637 37229 01 33575 01	FE II	1686 x Ø60 x 30 
 Ersatzteil bzw. Rep.Satz spare part or rep.-kit	05.030.3040.110, Kugelgelenk Ball Joint		











ST-Artikel ST-Article	Vergleichs-Nr. Comparison No.	passend für to fit to	Details Details
05.010.4256.330 Spurstange Tie Rod 	20 582 398 22 482 975 29438 01	FL III	1650 x Ø40 x 30 
 Ersatzteil bzw. Rep.Satz spare part or rep.-kit	05.030.0907.019, Kugelgelenk Ball Joint 05.030.0907.029, Kugelgelenk Ball Joint		
05.010.4256.340 Spurstange Tie Rod 	22 163 638 37233 01 35594 01	Volvo	1818 x Ø58 x 30 
05.020.4002.240 Lenkstange Drag Rod 	20 393 069 3988 704 19663 01	FH 12, FH 16, FM 10, FM 12, FM 7	880 x Ø52 x 28,6 
 Ersatzteil bzw. Rep.Satz spare part or rep.-kit	05.030.4002.449, Kugelgelenk Ball Joint		
05.020.4002.242 Lenkstange Drag Rod 	20 777 411 33583 01	FE II	825 x Ø62 x 30 

ST-Artikel ST-Article	Vergleichs-Nr. Comparison No.	passend für to fit to	Details Details
05.020.4002.243 Lenkstange Drag Rod 	20 367 555 26778 01	FH 12, FH 16, FM, FM 12, FM 9	160 x Ø25 x 28,6 
05.020.4002.250 Lenkstange Drag Rod 	1626 751 1610 338 11969 02	F 10, F 12, F 16	845 x Ø42 x 31,5 
 Ersatzteil bzw. Rep.Satz spare part or rep.-kit	05.030.4002.480, Kugelgelenk Ball Joint		
05.020.4002.270 Lenkstange Drag Rod 	1606 283 1576 092 11965 01	F 10, F 12	860 x Ø42 x 31,5 
 Ersatzteil bzw. Rep.Satz spare part or rep.-kit	05.030.4002.480, Kugelgelenk Ball Joint		
05.020.4002.280 Lenkstange Drag Rod 	1075 005 19521 01	FH 12, FH 16	870 x Ø50 x 28,6 
 Ersatzteil bzw. Rep.Satz spare part or rep.-kit	05.030.4002.449, Kugelgelenk Ball Joint		













ST-Artikel ST-Article	Vergleichs-Nr. Comparison No.	passend für to fit to	Details Details
05.020.4002.290 Lenkstange Drag Rod 	20 393 061 3988 697 22791 01	FH 12, FH 16, FM 12, FM 7	880 x Ø52 x 28,6 
<i>i</i> Ersatzteil bzw. Rep.Satz spare part or rep.-kit	05.030.4002.449, Kugelgelenk Ball Joint		
05.020.4002.300 Lenkstange Drag Rod 	6790 572 12147 02	FL 6	870 x Ø42 x 26 
<i>i</i> Ersatzteil bzw. Rep.Satz spare part or rep.-kit	05.030.1907.209, Kugelgelenk Ball Joint		
05.020.4002.330 Lenkstange Drag Rod 	1592 940 11942 01	FL 10, FL 12, FL 7	810 x Ø50 x 31,5 
<i>i</i> Ersatzteil bzw. Rep.Satz spare part or rep.-kit	05.030.4002.480, Kugelgelenk Ball Joint		
05.020.4002.360 Lenkstange Drag Rod 	20 393 059 8156 657 23553 01 23534 01	FH 12, FH 16, FM 12, FM 7	881 x Ø52 x 28,6 
<i>i</i> Ersatzteil bzw. Rep.Satz spare part or rep.-kit	05.030.4002.449, Kugelgelenk Ball Joint		

ST-Artikel ST-Article	Vergleichs-Nr. Comparison No.	passend für to fit to	Details Details
05.020.4002.370 Lenkstange Drag Rod 	85 114 200 1628 636 19884 01	FH 12, FH 16	880 x Ø52 x 28,6 
 Ersatzteil bzw. Rep.Satz spare part or rep.-kit	05.030.4002.449, Kugelgelenk Ball Joint		
05.020.4002.570 Lenkstange Drag Rod 	20 400 944 1071 344 11949 01	FL 6	870 x Ø52 x 26 
 Ersatzteil bzw. Rep.Satz spare part or rep.-kit	05.030.1907.209, Kugelgelenk Ball Joint		
05.020.4002.580 Lenkstange Drag Rod 	20 393 075 1629 397 25010 01	FH 16	875 x Ø50 x 28,6 
 Ersatzteil bzw. Rep.Satz spare part or rep.-kit	05.030.4002.449, Kugelgelenk Ball Joint		
05.020.4002.600 Lenkstange Drag Rod 	20 400 909 3124 480 18475 01	FL, FL 6	980 x Ø30 x 22 
 Ersatzteil bzw. Rep.Satz spare part or rep.-kit	05.030.1980.860, Kugelgelenk Ball Joint		

ST-Artikel ST-Article	Vergleichs-Nr. Comparison No.	passend für to fit to	Details Details
05.020.4002.680 Lenkstange Drag Rod 	6799 190 19686 01	FL 6	893 x Ø40 x 30 
 Ersatzteil bzw. Rep.Satz spare part or rep.-kit	05.030.4007.017, Kugelgelenk Ball Joint		
05.020.4004.710 Lenkstange Drag Rod 	1592 939 11941 01	FL 10, FL 12, FL 7	820 x Ø50 x 31,5 
 Ersatzteil bzw. Rep.Satz spare part or rep.-kit	05.030.4002.480, Kugelgelenk Ball Joint		
05.020.4004.720 Lenkstange Drag Rod 	1071 170 22548 01	FL 6	821 x Ø42 x 26 
 Ersatzteil bzw. Rep.Satz spare part or rep.-kit	05.030.1907.209, Kugelgelenk Ball Joint		
05.020.4004.740 Lenkstange Drag Rod 	24 425 658 20 513 949 25439 01	FM 12	2111 x Ø52 x 28,6 

ST-Artikel ST-Article	Vergleichs-Nr. Comparison No.	passend für to fit to	Details Details
05.020.4004.760 Lenkstange Drag Rod 	20 393 063 1075 664 19873 01	FH 12, FH 16, FM 12, FM 7	860 x Ø52 x 28,6 
 Ersatzteil bzw. Rep.Satz spare part or rep.-kit	05.030.4002.449, Kugelgelenk Ball Joint		
05.020.4004.770 Lenkstange Drag Rod 	20 393 079 1628 635 23523 01	FH 12, FH 16, FM 10, FM 12, FM 7, NH 12	875 x Ø50 x 28,6 
 Ersatzteil bzw. Rep.Satz spare part or rep.-kit	05.030.4002.449, Kugelgelenk Ball Joint		
05.020.4004.820 Lenkstange Drag Rod 	24 425 662 20 442 115 25441 01	FH 12, FM 12	2140 x Ø52 x 28,6 
05.020.4004.830 Lenkstange Drag Rod 	20 393 186 20 375 555 37458 01	FH, FH 12, FH 16, FM 12, FM 7, FM 9	870 x Ø52 x 26,8 
 Ersatzteil bzw. Rep.Satz spare part or rep.-kit	05.030.4002.449, Kugelgelenk Ball Joint		

ST-Artikel ST-Article	Vergleichs-Nr. Comparison No.	passend für to fit to	Details Details
05.020.4004.880 Lenkstange Drag Rod 	1080 786 27716 01	FL 10, FL 12, FL 7	856 x Ø42 x 31,5 
 Ersatzteil bzw. Rep.Satz spare part or rep.-kit	05.030.4002.480, Kugelgelenk Ball Joint		
05.020.4004.900 Lenkstange Drag Rod 	1071 169 21986 01	FL 6	821 x Ø42 x 26 
 Ersatzteil bzw. Rep.Satz spare part or rep.-kit	05.030.1907.209, Kugelgelenk Ball Joint		
05.020.4004.910 Lenkstange Drag Rod 	1075 006 19889 01	FH 12, FH 16	866 x Ø52 x 28,6 
 Ersatzteil bzw. Rep.Satz spare part or rep.-kit	05.030.1912.610, Kugelgelenk Ball Joint		
05.020.4004.920 Lenkstange Drag Rod 	20 393 083 1088 985 24382 01	FH 12, FH 16, FM 12, FM 7, NH 12	572 x Ø38 x 28,6 
 Ersatzteil bzw. Rep.Satz spare part or rep.-kit	05.030.4002.439, Kugelgelenk Ball Joint 05.030.4002.449, Kugelgelenk Ball Joint		













ST-Artikel ST-Article	Vergleichs-Nr. Comparison No.	passend für to fit to	Details Details
05.020.4004.940 Lenkstange Drag Rod 	6799 189 20890 01	FL 6	893 x Ø40 x 30 
 Ersatzteil bzw. Rep.Satz spare part or rep.-kit	05.030.4007.017, Kugelgelenk Ball Joint		
05.020.4004.950 Lenkstange Drag Rod 	1626 670 19883 01	FL 10, FL 12, FL 7	848 x Ø42 x 31,5 
 Ersatzteil bzw. Rep.Satz spare part or rep.-kit	05.030.4002.480, Kugelgelenk Ball Joint		
05.020.4004.980 Lenkstange Drag Rod 	1626 672 1194 824 23538 01	FL 10, FL 12	822 x Ø42 x 31,5 
 Ersatzteil bzw. Rep.Satz spare part or rep.-kit	05.030.4002.450, Kugelgelenk Ball Joint 05.030.4002.480, Kugelgelenk Ball Joint		
05.020.4004.990 Lenkstange Drag Rod 	21 252 480 20 374 831 37978 01 30948 01	FH 12, FH 16, FM 12	563 x Ø48 x 28,6 
 Ersatzteil bzw. Rep.Satz spare part or rep.-kit	05.030.4007.038, Kugelgelenk Ball Joint		



ST-Artikel ST-Article	Vergleichs-Nr. Comparison No.	passend für to fit to	Details Details
05.020.4007.007 Lenkstange Drag Rod 	20 393 071 8190 146 22792 01	FH 12, FH 16, FM 12, FM 7	888 x Ø52 x 28,6 
<i>i</i> Ersatzteil bzw. Rep.Satz spare part or rep.-kit	05.030.4002.449, Kugelgelenk Ball Joint		
05.020.4007.009 Lenkstange Drag Rod 	20 393 073 8190 147 19689 01	F 10, FH 12, FH 16, FM 12, FM 7	888 x Ø52 x 28,6 
<i>i</i> Ersatzteil bzw. Rep.Satz spare part or rep.-kit	05.030.4002.449, Kugelgelenk Ball Joint		
05.020.4007.010 Lenkstange Drag Rod 	24 425 660 25440 01	FH 12, FM 12, NH 12	2140 x Ø52 x 28,6 
05.020.4007.027 Lenkstange Drag Rod 	21 106 952 20 393 187 28091 01	FH 12, FH 16, FM 12, FM 7	863 x Ø52 x 28,6 
<i>i</i> Ersatzteil bzw. Rep.Satz spare part or rep.-kit	05.030.4007.038, Kugelgelenk Ball Joint		

ST-Artikel ST-Article	Vergleichs-Nr. Comparison No.	passend für to fit to	Details Details
05.020.4007.032 Lenkstange Drag Rod 	85 114 187 1071 316 23547 01	FL 6	910 x Ø42 x 30 
 Ersatzteil bzw. Rep.Satz spare part or rep.-kit	05.030.4007.017, Kugelgelenk Ball Joint		
05.020.4007.033 Lenkstange Drag Rod 	21 106 936 20 390 745 27647 01	FH, FH 12, FH 16, FM 12, FM 7, FM 9	885 x Ø50 x 28,6 
 Ersatzteil bzw. Rep.Satz spare part or rep.-kit	05.030.4007.038, Kugelgelenk Ball Joint		
05.020.4007.070 Lenkstange Drag Rod 	20 393 067 3988 767 25255 01	FH 16, FM 10, FM 12, FM 7, FM 9	868 x Ø50 x 28,6 
 Ersatzteil bzw. Rep.Satz spare part or rep.-kit	05.030.4002.449, Kugelgelenk Ball Joint		
05.020.4007.071 Lenkstange Drag Rod 	20 393 065 3988 764 25789 01	FH 12, FH 16, FM 10, FM 12, FM 7, FM 9	868 x Ø50 x 28,6 
 Ersatzteil bzw. Rep.Satz spare part or rep.-kit	05.030.4002.449, Kugelgelenk Ball Joint		

ST-Artikel ST-Article	Vergleichs-Nr. Comparison No.	passend für to fit to	Details Details
05.020.4007.072 Lenkstange Drag Rod 	20 375 787 21 106 933 26779 01	FH 12, FH 16, FM, FM 12, FM 9	824 x Ø50 x 28,6 
<p>i Ersatzteil bzw. Rep.Satz spare part or rep.-kit 05.030.4007.038, Kugelgelenk Ball Joint</p>			
05.020.4007.073 Lenkstange Drag Rod 	20 453 063 31885 01	FH, FH II, FH 12, FH 16, FM, FM 12, FM 9	2139 x Ø62 x 28,6 
05.020.4007.074 Lenkstange Drag Rod 	1088 987 19526 01	FH 12, FH 16	2141 x Ø52 x 28,6 
<p>i Ersatzteil bzw. Rep.Satz spare part or rep.-kit 05.030.4002.449, Kugelgelenk Ball Joint</p>			
05.020.4007.075 Lenkstange Drag Rod 	20 581 632 31886 01	FH, FH II, FH 12, FH 16, FM, FM 12, FM 9	2339 x Ø62 x 28,6 

ST-Artikel ST-Article	Vergleichs-Nr. Comparison No.	passend für to fit to	Details Details
05.020.4007.076 Lenkstange Drag Rod 	20 453 064 20 584 291 34698 01	FH, FH II, FH 12, FH 16, FM, FM 12, FM 9	2139 x Ø62 x 28,6 
05.020.4007.077 Lenkstange Drag Rod 	20 393 077 20 428 433 25253 01	FH 12, FH 16	2141 x Ø52 x 28,6 
 Ersatzteil bzw. Rep.Satz spare part or rep.-kit	05.030.1912.610, Kugelgelenk Ball Joint		
05.020.4007.078 Lenkstange Drag Rod 	20 442 109 20 513 947 25438 01	FM 10, FM 12, FM 7	2111 x Ø52 x 28,6 
05.020.4007.079 Lenkstange Drag Rod 	20 390 746 21 106 968 31965 01	FH 12, FH 16, FM, FM 10, FM 12, FM 7, FM 9	881 x Ø50 x 28,6 
 Ersatzteil bzw. Rep.Satz spare part or rep.-kit	05.030.4007.038, Kugelgelenk Ball Joint		

ST-Artikel ST-Article	Vergleichs-Nr. Comparison No.	passend für to fit to	Details Details
05.020.4007.081 Lenkstange Drag Rod 	22 159 761 37231 01 35533 01	FH, FH 12, FH 16, FM, FM 12, FM 9	485 x Ø48 x 28,6 
 Ersatzteil bzw. Rep.Satz spare part or rep.-kit	05.030.4007.038, Kugelgelenk Ball Joint		
05.020.4007.083 Lenkstange Drag Rod 	22 159 757 37234 01 36735 01	FH, FH 12, FH 16, FM, FM 12, FM 9	1818 x Ø52 x 32 
 Ersatzteil bzw. Rep.Satz spare part or rep.-kit	05.030.0907.130, Kugelgelenk Ball Joint		
05.020.4007.084 Lenkstange Drag Rod 	20 709 844 25720 02 25720 01	FL, FL II	946 x Ø42 x 26 
 Ersatzteil bzw. Rep.Satz spare part or rep.-kit	05.030.1907.209, Kugelgelenk Ball Joint		
05.020.4007.085 Lenkstange Drag Rod 	20 818 840 35593 01	FL, FL II, FL III	922 x Ø42 x 26 
 Ersatzteil bzw. Rep.Satz spare part or rep.-kit	05.030.1907.209, Kugelgelenk Ball Joint		

ST-Artikel ST-Article	Vergleichs-Nr. Comparison No.	passend für to fit to	Details Details
05.030.0907.019	20 742 129	Volvo	125 x 30 / M30 x 1,5
Kugelgelenk Ball Joint	11492 03 11492 02 11390 01		
			
 Ersatzteil bzw. Rep.Satz spare part or rep.-kit	05.010.0280.900, Spurstange Tie Rod 05.010.0803.630, Spurstange Tie Rod 05.010.0994.510, Spurstange Tie Rod 05.010.1913.460, Spurstange Tie Rod 05.010.4007.067, Spurstange Tie Rod 05.010.4007.068, Spurstange Tie Rod 05.010.4256.320, Spurstange Tie Rod 05.010.4256.330, Spurstange Tie Rod 05.010.4256.350, Spurstange Tie Rod 05.020.0280.820, Lenkstange Drag Rod 05.020.0280.830, Lenkstange Drag Rod 05.020.0994.110, Lenkstange Drag Rod 05.020.0994.120, Lenkstange Drag Rod 05.020.0994.160, Lenkstange Drag Rod 05.020.0994.260, Lenkstange Drag Rod 05.020.0994.280, Lenkstange Drag Rod		
Komplementärteil complementary part	05.030.0907.029, Kugelgelenk Ball Joint		

05.030.0907.029

Kugelgelenk
Ball Joint



20 742 127

11505 03

11505 02

11389 01

Volvo

125 x 30 / M30 x 1,5



Ersatzteil bzw. Rep.Satz | spare part or rep.-kit

05.010.0280.900, Spurstange | Tie Rod
05.010.0803.630, Spurstange | Tie Rod
05.010.0994.510, Spurstange | Tie Rod
05.010.0994.550, Spurstange | Tie Rod
05.010.1913.460, Spurstange | Tie Rod
05.010.1913.510, Spurstange | Tie Rod
05.010.4007.067, Spurstange | Tie Rod
05.010.4007.068, Spurstange | Tie Rod
05.010.4256.320, Spurstange | Tie Rod
05.010.4256.330, Spurstange | Tie Rod
05.010.4256.350, Spurstange | Tie Rod
05.020.0280.390, Lenkstange | Drag Rod
05.020.0280.830, Lenkstange | Drag Rod
05.020.0803.760, Lenkstange | Drag Rod
05.020.0803.770, Lenkstange | Drag Rod
05.020.0803.780, Lenkstange | Drag Rod
05.020.0994.110, Lenkstange | Drag Rod
05.020.0994.120, Lenkstange | Drag Rod
05.020.0994.160, Lenkstange | Drag Rod
05.020.0994.170, Lenkstange | Drag Rod
05.020.0994.190, Lenkstange | Drag Rod
05.020.0994.260, Lenkstange | Drag Rod
05.020.0994.280, Lenkstange | Drag Rod
05.020.1913.250, Lenkstange | Drag Rod
05.020.1913.290, Lenkstange | Drag Rod
05.020.1913.330, Lenkstange | Drag Rod
05.020.1913.360, Lenkstange | Drag Rod
05.020.1913.370, Lenkstange | Drag Rod
05.020.1913.380, Lenkstange | Drag Rod
05.020.1913.410, Lenkstange | Drag Rod
05.020.4256.370, Lenkstange | Drag Rod

Komplementärteil | complementary part

05.030.0907.019, Kugelgelenk | Ball Joint

05.030.0907.130

Kugelgelenk
Ball Joint



20 937 674

25353 01

FE, FH, FL, FL II, FL 10, FL 12,
FL 6, FL 7

140 x 30 / M30 x 1,5



Ersatzteil bzw. Rep.Satz | spare part or rep.-kit

05.010.0280.380, Spurstange | Tie Rod
05.010.0994.520, Spurstange | Tie Rod
05.010.3001.910, Spurstange | Tie Rod
05.020.0280.820, Lenkstange | Drag Rod
05.020.0994.140, Lenkstange | Drag Rod
05.020.0994.270, Lenkstange | Drag Rod

ST-Artikel ST-Article	Vergleichs-Nr. Comparison No.	passend für to fit to	Details Details
05.030.0907.200 Kugelgelenk Ball Joint 	3099 128 3090 291 30756 01	FH 12, FH 16, FL 10, FL 12, NH 12	86 x 38 / M30 x 1,5 
05.030.0993.730 Kugelgelenk Ball Joint 	1606 980 19537 01 25064 01 19862 01	FL 10, FL 6, NL 12	95 x 30 / M26 x 1,5 
05.030.1907.120 Kugelgelenk Ball Joint 	1517 440 1517 444 11378 01	F 6	101 x 22 / M28 x 1,5 
<i>i</i> Ersatzteil bzw. Rep.Satz spare part or rep.-kit Komplementärteil complementary part	05.010.1913.480, Spurstange Tie Rod 05.020.0994.250, Lenkstange Drag Rod 05.030.1907.160, Kugelgelenk Ball Joint		
05.030.1907.160 Kugelgelenk Ball Joint 	1517 279 1517 439 11379 01	F 6	101 x 22 / M28 xx 1,5 
<i>i</i> Komplementärteil complementary part	05.030.1907.120, Kugelgelenk Ball Joint		

ST-Artikel
ST-Article

Vergleichs-Nr.
Comparison No.

passend für
to fit to

Details
Details

05.030.1907.180

Kugelgelenk
Ball Joint



1518 142
1190 778

11376 02
11376 01
19667 01

F 10, F 12

95 x 20 / M24 x 1,5



Komplementärteil | complemen-
tary part

05.030.1907.190, Kugelgelenk | Ball Joint

05.030.1907.190

Kugelgelenk
Ball Joint



1517 448

11377 03
11377 01

Volvo

95 x 20 / M24 x 1,5



Komplementärteil | complemen-
tary part

05.030.1907.180, Kugelgelenk | Ball Joint

05.030.1907.209

Kugelgelenk
Ball Joint



1697 247
1695 690

11402 01
25718 01
24570 01

FL 6

120 x 26 / M30 x 1,5



Ersatzteil bzw. Rep.Satz | spare
part or rep.-kit













05.010.1913.500, Spurstange | Tie Rod
05.020.0280.800, Lenkstange | Drag Rod
05.020.0994.560, Lenkstange | Drag Rod
05.020.0994.570, Lenkstange | Drag Rod
05.020.1913.280, Lenkstange | Drag Rod
05.020.4007.084, Lenkstange | Drag Rod
05.020.4007.085, Lenkstange | Drag Rod

Komplementärteil | complemen-
tary part

05.030.1907.549, Kugelgelenk | Ball Joint

ST-Artikel ST-Article	Vergleichs-Nr. Comparison No.	passend für to fit to	Details Details
05.030.1907.410 Kugelgelenk Ball Joint 	1696 920 11381 01	FL 6	106 x 22 / M24 x 1,5 
05.030.1907.549 Kugelgelenk Ball Joint 	1698 839 1695 689 11403 01 11728 01 19675 01	FL 6	120 x 26 / M30 x 1,5 
 Komplementärteil complemen- tary part	05.030.1907.209, Kugelgelenk Ball Joint		
05.030.1980.860 Kugelgelenk Ball Joint 	1696 919 11380 01 19674 01 11380 02	FL 6	106 x 22 / M24 x 1,5 
 Komplementärteil complemen- tary part	05.030.1907.410, Kugelgelenk Ball Joint		
05.030.4002.411 Kugelgelenk Ball Joint 	1527 234 0382 745 11954 01	F 10, F 12, F 16, F 7, FL 10, FL 12, FL 6, FL 7, FS 7, N 10, N 12, NL 10, NL 12, Volvo	87 x 16 / M28 x 1,5 

ST-Artikel ST-Article	Vergleichs-Nr. Comparison No.	passend für to fit to	Details Details
05.030.4002.420 Kugelgelenk Ball Joint 	20 710 008 31961 01	FH 12, FH 16, FM 12, FM 9	136 x 32 / M30 x 1,5 
 Ersatzteil bzw. Rep.Satz spare part or rep.-kit	05.010.4007.063, Spurstange Tie Rod		
05.030.4002.439 Kugelgelenk Ball Joint 	1698 847 1698 533 11947 02	F 10, F 12, F 16, FH, FH 12, FH 16, FL 10, FL 12, FL 6, FL 7, FM 10, FM 12, FM 7, FM 9, N 10, N 12, NL 10, NL 12	125 x 28,6 / M30 x 1,5 
 Komplementärteil complementary part	05.030.4002.449, Kugelgelenk Ball Joint		
05.030.4002.449 Kugelgelenk Ball Joint 	1698 846 1698 532 11946 02	F 10, F 12, F 16, F 7, FH, FH 12, FH 16, FL 10, FL 12, FL 6, FL 7, FM 12, FM 7, N 10, N 12, NL 10, NL 12	125 x 28,6 / M30 x 1,5 
 Ersatzteil bzw. Rep.Satz spare part or rep.-kit Komplementärteil complementary part	05.020.4007.070, Lenkstange Drag Rod 05.020.4007.071, Lenkstange Drag Rod 05.020.4007.074, Lenkstange Drag Rod 05.030.4002.439, Kugelgelenk Ball Joint		
05.030.4002.450 Kugelgelenk Ball Joint 	85 114 147 1698 840 11945 01 11945 02	F 10, F 12, F 16, FL 10, FL 12, FL 7, NL 10, NL 12	125 x 31,5 / M30 x 1,5 
 Komplementärteil complementary part	05.030.4002.480, Kugelgelenk Ball Joint		

ST-Artikel ST-Article	Vergleichs-Nr. Comparison No.	passend für to fit to	Details Details
05.030.4002.460 Kugelgelenk Ball Joint 	6889 484 1699 401 11968 01	F 10, F 12, F 16, FL 10, FL 12, FL 7	167 x 28,6 / M52 x 1,5 
 Komplementärteil complemen- tary part	05.030.4002.470, Kugelgelenk Ball Joint		
05.030.4002.470 Kugelgelenk Ball Joint 	6889 483 1699 400 11967 01	F 10, F 12, F 16, FL 10, FL 12, FL 7	167 x 28,6 / M52 x 1,5 
 Komplementärteil complemen- tary part	05.030.4002.460, Kugelgelenk Ball Joint		
05.030.4002.480 Kugelgelenk Ball Joint 	85 114 146 1695 776 11944 01 11944 02	F 10, F 12, F 16, FL 10, FL 12, FL 7, NL 10, NL 12	125 x 31,5 / M30 x 1,5 
 Komplementärteil complemen- tary part	05.030.4002.450, Kugelgelenk Ball Joint		
05.030.4004.840 Kugelgelenk Ball Joint 	21 263 974 3099 529 22647 01	FH 12, FH 16, FL 12, FM 12, FM 7	145 x 28,6 / M30 x 1,5 
 Ersatzteil bzw. Rep.Satz spare part or rep.-kit	05.010.4007.062, Spurstange Tie Rod		

ST-Artikel ST-Article	Vergleichs-Nr. Comparison No.	passend für to fit to	Details Details
05.030.4007.017 Kugelgelenk Ball Joint	3098 332 1698 047 25552 01 19887 01	FL 6	125 x 30 / M30 x 1,5 
			
05.030.4007.030 Kugelgelenk Ball Joint	8151 876 27632 01	FH 12, FH 16, FL 10, FL 12, FL 7, FM 10, FM 12, FM 7, NH 12	100 x 38 / M26 x 1,5 
			
05.030.4007.038 Kugelgelenk Ball Joint	3093 647 27547 02	FH, FH 12, FH 16, FL 6, FM, FM 10, FM 12, FM 7, FM 9, NH 12	140 x 28,6 / M30 x 1,5 
	05.010.4007.064, Spurstange Tie Rod 05.010.4007.066, Spurstange Tie Rod 05.020.4007.072, Lenkstange Drag Rod 05.020.4007.079, Lenkstange Drag Rod 05.020.4007.081, Lenkstange Drag Rod		
 Ersatzteil bzw. Rep.Satz spare part or rep.-kit			
05.030.4007.041 Kugelgelenk Ball Joint	3097 999 85 104 188 21687 01	FH, FH 12, FH 16, FL 6, FM 12, FM 7	120 x 28,6 / M38 x 1,5 
			

ST-Artikel ST-Article	Vergleichs-Nr. Comparison No.	passend für to fit to	Details Details
05.030.4007.042 Kugelgelenk Ball Joint 	3193 731 28792 01	FH 12, FH 16, FM 12, FM 9	120 x 28,8 / M26 x 1,5 
05.030.4007.043 Kugelgelenk Ball Joint 	20 581 089 34527 01	FH, FH 12, FH 16, FM, FM 12, FM 9	136 x 32 / M30 x 1,5 
 Ersatzteil bzw. Rep.Satz spare part or rep.-kit	05.010.4007.063, Spurstange Tie Rod		
05.030.4007.044 Kugelgelenk Ball Joint 	20 374 698 27633 01	FH 12, FH 16, FL 6, FM 12, FM 7, FM 9	88 x 28,8 / M26 x 1,5 
05.030.4007.046 Kugelgelenk Ball Joint 	3987 648 27634 01	FH 12, FH 16, FM 12, FM 7, FM 9	88 x 28,6 / M26 x 1,5 

ST-Artikel
ST-Article

Vergleichs-Nr.
Comparison No.

passend für
to fit to

Details
Details

05.050.4014.000

Hydraulikpumpe, Lenkung
Hydraulic Pump, Steering

20 453 450

8694.974.519

FM, FM 12, FM 9

M26x1,5 / M16x1,5



05.050.4014.010

Hydraulikpumpe, Lenkung
Hydraulic Pump, Steering

85 000 031

3986 328

7684.974.704

FH 12, FM 12

M26x1,5 / M18x1,5



05.050.4014.020

Hydraulikpumpe, Lenkung
Hydraulic Pump, Steering

20 453 453

20 482 481

7684.955.763

FH, FH 16, FM, FM 9

M26x1,5 / M16x1,5



05.050.4014.030

Hydraulikpumpe, Lenkung
Hydraulic Pump, Steering

1589 925

5001 933

7673.955.202

FL 6, FL 7

M26x1,5 / M16x1,5



ST-Artikel ST-Article	Vergleichs-Nr. Comparison No.	passend für to fit to	Details Details
05.050.4014.040 Hydraulikpumpe, Lenkung Hydraulic Pump, Steering 	1585 013 5001 934 7673.955.211	F 10, N 10	M26x1,5 / M16x1,5 
05.050.4014.050 Hydraulikpumpe, Lenkung Hydraulic Pump, Steering 	3172 197 8112 963 542 0018 10	FH 12, FL 12, FM 10, FM 7, NH 12	M26x1,5 / M16x1,5 
05.050.4014.060 Hydraulikpumpe, Lenkung Hydraulic Pump, Steering 	85 103 705 85 114 317 7685 955 791	FH, FH 16, FM, FM 9	
05.050.4014.070 Hydraulikpumpe, Lenkung Hydraulic Pump, Steering 	24 424 124 85 114 318 7686 955 729 8696 974 502	FH, FH 16, FM	



Crossliste

Crosslist





T-Nr. T-No.	Vergl.-Nr. Comp.-No.	Seite page
05.010.0269.990	1353 396 1286 343 37451 01 21805 01	101
05.010.0275.700	1337 644 1270 854 21807 01	34, 69, 101
05.010.0280.050	1353 391 1270 853 20593 01	101
05.010.0280.051	1353 395 1351 205 27850 01	101
05.010.0280.240	1361 157 1295 415 1353 400 23234 01 24816 01	69
05.010.0280.310	1361 155 1297 572 21592 01	102
05.010.0280.320	1286 342 275 962 21804 01	102
05.010.0280.380	1286 341 23238 01	102
05.010.0280.540	1700 001 33981 01	102
05.010.0280.580	1700 000 33980 01	103
05.010.0280.900	1732 972 33978 01	103
05.010.0280.910	1732 980 37232 01 33979 01	103
05.010.0780.016	450495 185772 22361 01	69
05.010.0780.017	450496 185771 22334 01	69
05.010.0803.070	5 0030 7556 9840 2553 21385 01	124
05.010.0803.071	4100 5460 4100 5309 0816 5309 25318 01	124
05.010.0803.072	4129 6162 35513 01	124

T-Nr. T-No.	Vergl.-Nr. Comp.-No.	Seite page
05.010.0803.074	5 0403 4521 30078 01	124
05.010.0803.180	4100 5451 4100 5450 4103 6943 4104 2938 0816 3773 21285 01	21, 125
05.010.0803.390	0485 4871 25175 01	125
05.010.0803.540	9846 9650 9844 9025 20423 01	125
05.010.0803.550	4211 8694 4211 8782 4211 5532 23255 01	125
05.010.0803.630	4103 2608 4103 3237 27892 01	126
05.010.0993.201	81.46711.6892 81.46711.6891 81.46711.6804 81.46711.6802 81.46711.6895 81.46711.6808 31773 01	138
05.010.0993.202	81.46711.6894 81.46711.6893 81.46711.6896 81.46711.6803 31882 01	138
05.010.0993.204	81.46711.6579 81.46711.6720 81.46711.6730 81.46711.6831 25276 01	138
05.010.0993.210	81.46711.6820 81.46711.6725 81.46711.6849 81.46710.6361 81.46710.6165 81.46710.6354 81.46710.6198 81.46710.6163 81.46710.6353 81.46710.6112 11768 01	138

T-Nr. T-No.	Vergl.-Nr. Comp.-No.	Seite page	T-Nr. T-No.	Vergl.-Nr. Comp.-No.	Seite page
05.010.0993.220	81.46711.6736	24, 48, 139	05.010.0993.450	81.46711.6729	140
	81.46711.6747				
	81.46711.6830				
	81.46710.6911				
	81.46710.6912				
	81.46710.6953				
	81.46710.6830				
	81.46710.6379				
	81.46710.6836				
	81.46710.6378				
	81.46710.6167				
	81.46710.6194				
	81.46710.6134				
	81.46710.6122				
	81.46710.6380				
	81.46710.6195				
	11770 01				
	05.010.0993.260			81.46710.6393	
81.46710.6388					
81.46710.6394					
81.46710.6189					
81.46710.6369					
81.46710.6367					
81.46710.6368					
81.46710.6162					
81.46710.6164					
81.46710.6118					
21282 01					
05.010.0993.270	81.46711.6724	139	05.010.0993.610	81.46711.6715	24, 48
	81.46710.6904				
	81.46711.6795				
	81.46710.6903				
	81.46711.6853				
	81.46710.6948				
	81.46710.6816				
	81.46710.6397				
	81.46710.6360				
	81.46710.6266				
	81.46710.6395				
	81.46710.6362				
	81.46710.6265				
	81.46710.6815				
	81.46710.6396				
	81.46710.6359				
	81.46710.6131				
	19995 01				
05.010.0993.330	81.46711.6921	24, 139	05.010.0993.700	81.46710.6316	25, 140
	81.46711.6860				
	81.46711.6861				
	81.46711.6863				
	81.46711.6862				
	81.46711.6848				
	81.46711.6791				
	81.46711.6859				
	81.46711.6858				
	81.46711.6773				
	25395 01				
05.010.0993.400	81.46711.6726	140	05.010.0993.810	81.46711.6762	25
	81.46710.6994				
	23305 01				
05.010.0993.410	81.46711.6728	140	05.010.0993.820	81.46711.6764	25
	81.46710.6866				
	81.46710.6865				
	20889 01				
05.010.0993.300	81.46711.6921	24, 139	05.010.0993.910	81.46711.6711	25, 141
	81.46711.6860				
	81.46711.6861				
	81.46711.6863				
	81.46711.6862				
	81.46711.6848				
	81.46711.6791				
	81.46711.6859				
	81.46711.6858				
	81.46711.6773				
	25395 01				
05.010.0993.400	81.46711.6726	140	05.010.0993.920	81.46711.6714	141
	81.46710.6994				
	23305 01				
05.010.0993.410	81.46711.6728	140	05.010.0994.060	81.46711.6877	26, 48
	81.46710.6866				
	81.46710.6865				
	20889 01				
05.010.0993.300	81.46711.6921	24, 139	05.010.0994.180	81.46711.6743	141
	81.46711.6860				
	81.46711.6861				
	81.46711.6863				
	81.46711.6862				
	81.46711.6848				
	81.46711.6791				
	81.46711.6859				
	81.46711.6858				
	81.46711.6773				
	25395 01				



T-Nr. T-No.	Vergl.-Nr. Comp.-No.	Seite page
05.010.0994.510	81.46711.6933 81.46711.6934 35809 01	141
05.010.0994.520	81.46711.6801 81.46711.6864 81.46711.6865 81.46711.6869 34594 01	142
05.010.0994.530	81.46711.6818 81.46711.6819 81.46711.6887 34595 01	142
05.010.0994.550	81.46710.6918 81.46711.6740 82.46710.6031 23265 01	142
05.010.0994.590	627 330 02 03 8.226.326.000 8.226.326.000.B 8.226.328.000 8.226.328.000.C 19616 01	59
05.010.1910.200	602 330 09 03 602 330 10 03 602 330 54 03 602 330 53 03 11450 01	84
05.010.1910.201	405 330 02 03 405 330 01 03 33398 01	164
05.010.1910.210	602 330 03 03 602 330 04 03 602 330 00 03 11449 02	84
05.010.1910.230	385 330 14 03 385 330 15 03 385 330 11 03 385 330 05 03 385 330 06 03 12865 01	34, 164
05.010.1910.310	944 330 05 03 346 330 49 03 346 330 39 03 944 330 17 03 625 330 32 03 24315 01 23997 01	164
05.010.1910.320	393 330 07 03 393 330 04 03 371 330 70 03 393 330 03 03 393 330 02 03 393 330 00 03 11439 01	164

T-Nr. T-No.	Vergl.-Nr. Comp.-No.	Seite page
05.010.1910.370	676 330 07 03 676 330 09 03 676 330 02 03 676 330 04 03 12879 01	165
05.010.1910.380	676 330 08 03 676 330 10 03 676 330 03 03 676 330 05 03 18446 01	34, 165
05.010.1910.450	638 460 02 05 25459 01	84
05.010.1910.460	901 460 02 05 901 460 04 55 2D0 422 803 27756 01	84, 99
05.010.1910.520	941 330 02 03 941 330 01 03 941 330 00 03 941 330 05 03 941 330 03 03 23988 01	165
05.010.1910.530	942 330 24 03 942 330 16 03 942 330 03 03 942 330 04 03 30478 01	165
05.010.1910.590	631 330 06 03 12843 01	85
05.010.1910.770	631 330 07 03 631 330 05 03 12841 01	85
05.010.1910.780	631 460 07 05 12845 01	85
05.010.1910.790	677 330 03 03 677 330 04 03 18448 01	166
05.010.1910.830	942 330 00 03 942 330 23 03 942 330 07 03 942 330 11 03 942 330 01 03 942 330 02 03 37332 01	166
05.010.1911.510	970 330 04 03 970 330 02 03 970 330 01 03 970 330 03 03 970 330 00 03 23977 01	166
05.010.1911.520	949 330 04 03 949 330 23 03 949 330 14 03 949 330 08 03 949 330 05 03 37330 01	166

aufsteigend nach Templin-Nr. | ascending to Templin-No.

T-Nr. T-No.	Vergl.-Nr. Comp.-No.	Seite page	T-Nr. T-No.	Vergl.-Nr. Comp.-No.	Seite page	
05.010.1911.630	945 330 06 03	167	05.010.1912.420	385 330 16 03	168	
	945 330 09 03			385 330 18 03		
	945 330 01 03			385 330 08 03		
	945 330 00 03			385 330 02 03		
	945 330 04 03			13556 01		
	37329 01					
05.010.1911.680	670 330 06 03	85	05.010.1912.430	945 330 05 03	169	
	670 330 03 03			945 330 03 03		
	670 330 02 03			945 330 02 03		
	670 330 01 03		23989 01			
	669 330 04 03		05.010.1912.460	416 330 00 03	169	
	669 330 05 03			13560 01		
	670 330 00 03					
12877 01						
05.010.1911.740	949 330 17 03	167	05.010.1912.580	356 330 01 03	34	
	949 330 10 03			613 330 01 03		
	949 330 11 03		18427 01			
	949 330 21 03		05.010.1912.590	385 330 21 03	169	
23994 01	385 330 22 03					
	385 330 13 03					
05.010.1911.750	617 330 02 03	167	385 330 24 03	20397 01		
	617 330 03 03					
	22418 01					
05.010.1911.800	8.226.330.000 C	59	05.010.1912.600	356 330 00 03	35	
	8.226.331.000.0			613 330 00 03		
	627 330 01 03		13550 01			
	18494 01		05.010.1912.670	942 330 05 03	169	
	942 330 06 03					
	942 330 09 03					
05.010.1911.810	8.226.313.000 C	59	625 330 26 03	170		
	8.226.137.000		625 330 27 03			
	8.226.147.000 C		625 330 20 03			
	8.226.305.000 C		625 330 21 03			
	18493 01		22807 01			
05.010.1912.330	620 330 05 03	167	05.010.1912.690	944 330 02 03	170	
	620 330 06 03			625 330 12 03		
	19947 01			625 330 09 03		
05.010.1912.350	949 330 02 03	168	20430 01	170		
	949 330 03 03		05.010.1912.700		346 330 48 03	
	942 330 21 03				346 330 40 03	
	625 330 16 03		19721 01			
	625 330 25 03		05.010.1912.820		628 330 05 03	35, 59
	949 330 09 03				33303 01	
	625 330 24 03					
	625 330 15 03		05.010.1912.830		628 330 04 03	35, 60
	23992 01				33304 01	
	05.010.1912.370		424 330 03 03		168	05.010.1912.840
23970 01		33305 01				
05.010.1912.380	975 330 02 03	168, 231	05.010.1912.930	628 330 01 03	36	
	20 830 369			382 330 04 03		
	3099 230			37679 01		
	23996 01			26784 01		
05.010.1912.400	667 330 06 03	86	05.010.1912.940	949 330 16 03	170	
	667 330 05 03			949 330 06 03		
	667 330 04 03			949 330 07 03		
	667 330 03 03			949 330 15 03		
	20898 01			37331 01		
			23990 01			



T-Nr. T-No.	Vergl.-Nr. Comp.-No.	Seite page
05.010.1913.430	949 330 12 03 949 330 13 03 949 330 18 03 949 330 22 03 23995 01	170
05.010.1913.440	960 330 01 03 37258 01 36540 01	171
05.010.1913.460	357 460 35 05 942 330 10 03 942 330 17 03 942 330 25 03 3.574.603.505 24311 01	171
05.010.1913.480	669 330 06 03 669 330 07 03 23962 01	86, 171
05.010.1913.500	676 330 06 03 676 330 13 03 676 330 14 03 23972 01	171
05.010.1913.510	975 330 00 03 975 330 04 03 975 330 10 03 975 330 19 03 23998 01	172
05.010.3001.120	1 897 335 1 737 683 1 723 895 1 501 030 1 409 918 1 385 251 1 369 411 37247 01 22083 01 21010 01	218
05.010.3001.620	1 897 333 1 734 019 1 395 614 1 361 413 37547 01 23495 01 23495 02	53, 218
05.010.3001.910	1 388 958 1 734 021 1 897 334 23316 01	218
05.010.3001.920	2 125 091 2 146 104 37546 01 31883 01	218

T-Nr. T-No.	Vergl.-Nr. Comp.-No.	Seite page
05.010.3040.160	2 028 998 1 734 020 1 378 435 1 358 675 1 397 866 395 350 5000 613 598 19866 01 19866 02 27574 02	53, 205, 219
05.010.4002.390	3986 450 3988 711 3962 343 1628 637 22822 01 20581 01 23522 01	231
05.010.4002.620	20 497 798 85 114 240 9959 151 3112 050 21270 01	72
05.010.4007.011	21 260 286 20 393 097 1612 254 3985 570 3985 571 4510 697 37222 01 22794 01 21479 01	231
05.010.4007.012	3198 276 37223 01 27874 01	231
05.010.4007.013	1626 494 19882 02 19882 01	232
05.010.4007.014	1626 671 1599 175 1613 351 19539 01	232
05.010.4007.028	8156 123 26064 01	72, 232
05.010.4007.031	85 115 641 20 361 568 29614 01	232
05.010.4007.061	20 587 731 22 159 753 21 106 938 37227 01 31956 01	233
05.010.4007.062	21 260 275 22 159 760 3198 234 37224 01 27893 01	233

aufsteigend nach Templin-Nr. | ascending to Templin-No.

T-Nr. T-No.	Vergl.-Nr. Comp.-No.	Seite page	T-Nr. T-No.	Vergl.-Nr. Comp.-No.	Seite page
05.010.4007.063	20 581 086 7420 581 086 34528 01	233	05.010.4256.320	5001 869 828 5010 308 082 5010 566 059 27456 02	206
05.010.4007.064	20 399 543 22 159 769 21 299 034 85 115 631 7420 399 543 37225 01 28791 01	233	05.010.4256.330	5010 566 058 20 582 398 22 482 975 29438 01	207, 236
05.010.4007.065	1628 207 35333 01	72, 234	05.010.4256.340	5010 630 434 22 163 638 37233 01 35594 01	207, 236
05.010.4007.066	20 383 080 22 159 758 21 252 481 37230 01 35532 01	234	05.010.4256.350	5001 869 829 5010 439 631 29453 01 29950 01 29451 01	207
05.010.4007.067	20 742 117 1524 382 31539 01	234	05.010.4256.360	5010 439 022 5010 566 064 29954 01	207
05.010.4007.068	20 582 399 22 482 972 5010 566 051 34696 01	205, 234	05.020.0275.590	1283 203 23333 01	103
05.010.4251.501	5010 587 004 5010 600 822 5001 868 363 25 372 885 37228 01 33574 01	205, 235	05.020.0275.600	094 038 525 433 554 765	104
05.010.4256.131	5001 868 367 7421 560 968 5010 587 050 5010 587 053 25 370 845 33577 01	205, 235	05.020.0275.610	1351 734 1385 499 1291 060 22296 01	104
05.010.4256.132	5010 587 049 5010 587 052 5001 868 404 7421 560 965 25 370 844 33576 01	206, 235	05.020.0275.630	094 006 0094 006	104
05.010.4256.133	5001 868 366 5010 587 034 5010 587 038 7421 560 963 22 163 637 37229 01 33575 01	206, 235	05.020.0275.690	1351 730 1351 745 1385 488 593 883 21784 01	104
05.010.4256.150	5010 347 549 5 0314 0712 24008 01	19, 21	05.020.0275.750	1401 937 34025 01	105
05.010.4256.310	5010 439 021 5010 566 063 29454 01	206	05.020.0280.130	1351 731 1385 506 1315 530 1283 071 1283 070 19588 01	105
			05.020.0280.131	1433 449 1451 121 30998 01	105
			05.020.0280.132	1351 742 1311 449 1351 525 1385 511 23338 01	105

T-Nr. T-No.	Vergl.-Nr. Comp.-No.	Seite page
05.020.0280.133	1451 123 26829 01	106
05.020.0280.134	1433 448 1451 120 26843 01	106
05.020.0280.135	1351 722 1385 509 1287 409 1257 994 21770 01	106
05.020.0280.136	1405 499 34028 01	106
05.020.0280.137	1426 101 094 613 26830 01	107
05.020.0280.138	1351 739 1385 516 1306 336 23336 01	107
05.020.0280.139	1395 995 33982 01	107
05.020.0280.150	1700 913 1406 600 1401 946 34035 01	107
05.020.0280.260	1351 735 1385 500 1291 048 23334 01	108
05.020.0280.350	1700 912 1407 144 1405 655 1406 025 1401 940 34034 01	108
05.020.0280.390	1426 101 15107 01 26830 01	108
05.020.0280.400	1395 994 26826 01	108
05.020.0280.430	1269 973 1274 352 1351 723 23332 01	109
05.020.0280.450	890 992 19785 01	109
05.020.0280.470	1306 332 1351 740 1385 502 21542 01	109

T-Nr. T-No.	Vergl.-Nr. Comp.-No.	Seite page
05.020.0280.480	1602 821 1363 859 1448 063 26841 01	109
05.020.0280.490	1602 820 1448 062 1363 858 30290 01	110
05.020.0280.510	1395 993 26831 01	110
05.020.0280.530	1396 000 26833 01	110
05.020.0280.590	1700 914 1406 038 34036 01	110
05.020.0280.800	1351 737 1311 048 1385 498 23337 01	111
05.020.0280.810	1306 333 1351 741 1385 487 21543 01	111
05.020.0280.820	1451 118 31937 01	111
05.020.0280.830	1451 119 26828 01	111
05.020.0280.840	1395 999 26832 01	112
05.020.0803.090	9840 2544 9846 7459 19339 01	126
05.020.0803.300	0485 4874 18977 01	126
05.020.0803.320	4100 5463 0813 1582 0813 2397 4104 2919 19621 01	126
05.020.0803.340	9844 6354 19989 02	127
05.020.0803.400	4101 6964 4100 5466 18054 01	127
05.020.0803.460	4102 8269 26679 01	127
05.020.0803.470	4100 6093 4100 5475 23372 01	127

aufsteigend nach Templin-Nr. | ascending to Templin-No.

T-Nr. T-No.	Vergl.-Nr. Comp.-No.	Seite page	T-Nr. T-No.	Vergl.-Nr. Comp.-No.	Seite page
05.020.0803.720	5 0404 9893 33416 02	128	05.020.0993.243	81.46611.6156 81.46611.6155 81.46611.6154 34592 01	144
05.020.0803.760	4101 6961 4101 6960 4100 5469 4101 1476 0813 5492 23377 01	128	05.020.0993.250	81.46610.6305 81.46610.6301 81.46610.6328 17802 01	144
05.020.0803.770	5 0039 7738 27656 01	128	05.020.0993.280	85.46610.6102 85.46610.6030 85.46610.6201 81.46610.6724 81.46610.6725 81.46610.6001 19607 01	145
05.020.0803.780	4104 2749 35508 01	128	05.020.0993.340	81.46611.6199 81.46611.6200 81.46611.6206 81.46611.6135 81.46611.6134 81.46611.6137 81.46611.6107 81.46611.6104 81.46611.6105 30593 01	145
05.020.0907.050	81.46611.6216 81.46610.6722 81.46610.6333 81.46610.6723 81.46610.6721 81.46610.6334 81.46610.6361 81.46610.6360 81.46610.6355 81.46610.6354 11766 01	142	05.020.0993.380	81.46610.6779 81.46610.6782 81.46610.6780 20592 01	145
05.020.0907.210	82.46610.6184 82.46610.6185 81.46611.6151 28331 01	143	05.020.0993.420	81.46610.6656 81.46610.6659 81.46611.6006 19606 01	145
05.020.0907.220	81.46611.6161 81.46611.6162 81.46611.6163 81.46611.6152 82.46610.6187 82.46610.6186 82.46610.6183 28328 01	143	05.020.0993.430	85.46610.6104 81.46610.6754 81.46610.6753 20991 01	146
05.020.0907.260	81.46710.6434 81.46710.6435 81.46710.6456 25099 02 25099 01	143	05.020.0993.440	81.46710.6442 81.46710.6443 81.46710.6460 21408 01	146
05.020.0907.280	81.46611.6197 81.46611.6198 81.46611.6097 81.46611.6133 81.46611.6205 81.46611.6132 81.46611.6136 81.46611.6099 81.46611.6096 81.46611.6088 81.46611.6087 30592 01 25213 01 25717 01	143	05.020.0993.460	81.46611.6004 81.46611.6005 26916 01	146
05.020.0993.241	85.46610.6162 31895 01	144	05.020.0993.470	81.46710.6418 20396 01	146
05.020.0993.242	85.46610.6163 34591 01	144	05.020.0993.480	81.46710.6436 81.46710.6437 81.46710.6455 25100 02	147
			05.020.0993.600	81.46611.6016 81.46610.6684 81.46610.6375 357 460 23 05 357 460 20 05 21469 01	26, 36



T-Nr. T-No.	Vergl.-Nr. Comp.-No.	Seite page
05.020.0993.620	85.46610.6143 85.46610.6107 23464 02	147
05.020.0993.630	81.46611.6045 25629 01	26, 48
05.020.0993.640	81.46611.6067 81.46610.6708 84.46610.6059 21001 01	26
05.020.0993.650	85.46610.6142 85.46610.6112 85.46610.6212 85.46610.6012 23417 01	147
05.020.0993.660	85.46610.6140 85.46610.6021 85.46610.6121 23405 01	147
05.020.0993.670	81.46610.6304 81.46610.6329 81.46610.6300 81.46610.6303 81.46610.6327 81.46610.6281 18376 01	148
05.020.0993.680	81.46611.6201 81.46611.6203 81.46611.6202 81.46611.6139 81.46611.6138 30585 01	148
05.020.0993.690	81.46710.6438 81.46710.6439 18919 01	148
05.020.0993.720	81.46611.6063 81.46610.6313 11765 01	27
05.020.0993.750	85.46610.6152 85.46610.6018 85.46610.6118 85.46610.6218 24380 01	148
05.020.0993.760	81.46611.6013 81.46610.6691 24123 01	149
05.020.0993.770	81.46611.6019 81.46610.6374 22058 01	27, 149
05.020.0993.780	81.46611.6085 81.46611.6114 81.46611.6044 81.46610.6794 25630 01	27, 49

T-Nr. T-No.	Vergl.-Nr. Comp.-No.	Seite page
05.020.0993.790	85.46610.6156 28330 01	149
05.020.0993.880	85.46610.6150 85.46610.6019 85.46610.6119 23407 01	149
05.020.0993.890	85.46610.6141 85.46610.6105 85.46610.6005 25272 01	150
05.020.0993.900	81.46611.6061 81.46610.6654 20913 01	27
05.020.0993.930	82.46610.6191 81.46610.6790 81.46610.6791 23466 01	150
05.020.0993.940	81.46610.6798 81.46610.6578 81.46610.6876 18499 01	150
05.020.0994.030	85.46610.6146 85.46610.6123 85.46610.6239 85.46610.6052 23419 01	150
05.020.0994.110	81.46610.6767 81.46610.6768 81.46611.6014 25394 01	151
05.020.0994.120	81.46610.6159 81.46610.6200 81.46610.6275 81.46610.6317 81.46611.6064 81.46611.6211 81.46710.6280 23428 01	28, 151
05.020.0994.130	81.46610.6761 81.46610.6762 81.46610.6771 23268 01	151
05.020.0994.140	81.46710.6961 81.46711.6745 81.46711.6746 81.46711.6838 23304 01	151
05.020.0994.150	81.46610.6759 81.46610.6792 81.46610.6793 81.46610.6796 24120 01	152
05.020.0994.160	81.46610.6720 81.46711.6721 24126 01	28, 152

aufsteigend nach Templin-Nr. | ascending to Templin-No.

T-Nr. T-No.	Vergl.-Nr. Comp.-No.	Seite page	T-Nr. T-No.	Vergl.-Nr. Comp.-No.	Seite page
05.020.0994.170	82.46610.6057 82.46610.6147 27673 01	152	05.020.1907.340	383 460 45 05 383 460 24 05 383 460 16 05 383 460 08 05 12905 01	173
05.020.0994.190	85.46610.6147 28956 01	152	05.020.1907.390	385 460 34 05 385 460 20 05 385 460 08 05 13557 01	173
05.020.0994.250	85.46610.6160 85.46610.6246 31313 01	153	05.020.1907.500	387 460 44 05 387 460 45 05 387 460 06 05 11438 01	173
05.020.0994.260	81.46711.6855 81.46711.6856 81.46711.6857 81.46711.6950 31930 01	153	05.020.1907.640	309 460 32 05 309 460 31 05 601 460 03 05 309 460 29 05 601 460 01 05 601 460 00 05 309 460 30 05 309 460 03 05 309 460 12 05 309 460 10 05 309 460 13 05 309 460 22 05 309 460 26 05 309 460 24 05 309 460 05 05 309 460 08 05 309 460 04 05 309 460 09 05 309 460 23 05 309 460 11 05 309 460 25 05 309 460 14 05 601 460 02 05 309 460 20 05 30908 01	86
05.020.0994.270	81.46611.6146 81.46611.6147 81.46611.6204 34590 01	153	05.020.1907.760	300 460 06 05 300 460 07 05 305 460 03 05 30906 01	36
05.020.0994.280	81.46611.6157 81.46611.6158 81.46611.6159 34593 01	153	05.020.1910.240	668 460 09 05 668 460 11 05 668 460 05 05 668 460 07 05 11473 01	86
05.020.0994.560	85.46610.6103 85.46610.6032 85.46610.6202 35805 01	154	05.020.1910.241	972 460 15 05 972 460 17 05 24242 01	174
05.020.0994.570	85.46610.6056 35811 01	154	05.020.1910.242	002 460 10 05 003 460 29 05 000 460 85 05 27441 01	174
05.020.0994.580	81.46611.6174 81.46611.6175 81.46611.6176 35807 01	154	05.020.1910.250	670 460 26 05 670 460 27 05 12933 01	87
05.020.1907.010	316 460 08 05 316 460 06 05 316 460 09 05 316 460 07 05 11417 03	172			
05.020.1907.070	647 460 00 05 647 460 01 05 387 460 32 05 387 460 33 05 387 460 14 05 387 460 07 05 30911 01	172			
05.020.1907.250	002 460 96 05 002 460 97 05 27683 01	172			
05.020.1907.330	383 460 44 05 383 460 23 05 383 460 14 05 383 460 06 05 11435 01	173			



T-Nr. T-No.	Vergl.-Nr. Comp.-No.	Seite page
05.020.1910.260	601 460 15 05 601 460 13 05 601 460 14 05 601 460 12 05 601 460 11 05 601 460 10 05 601 460 09 05 601 460 08 05 601 460 07 05 601 460 06 05 601 460 05 05 11448 01	87
05.020.1910.280	620 460 28 05 620 460 37 05 620 460 00 05 620 460 20 05 387 460 04 05 387 460 50 05 000 460 17 05 30912 01 11460 01	174
05.020.1910.330	673 460 06 05 673 460 08 05 673 460 02 05 673 460 04 05 11475 01	174
05.020.1910.340	619 460 52 05 619 460 29 05 619 460 25 05 619 460 11 05 619 460 48 05 619 460 22 05 11457 01	175
05.020.1910.390	617 460 28 05 617 460 02 05 617 460 00 05 11454 01	175
05.020.1910.430	675 460 22 05 675 460 28 05 675 460 10 05 675 460 16 05 11477 01	175
05.020.1910.600	676 460 11 05 676 460 15 05 676 460 06 05 676 460 01 05 12936 01	175
05.020.1910.610	675 460 24 05 675 460 30 05 675 460 12 05 675 460 18 05 12935 01	176
05.020.1910.620	000 460 71 05 001 460 67 05 000 460 72 05 19904 01	176
05.020.1910.630	001 460 29 05 001 460 30 05 19699 01	176

T-Nr. T-No.	Vergl.-Nr. Comp.-No.	Seite page
05.020.1910.640	002 460 44 05 002 460 43 05 24243 01	176
05.020.1910.650	001 460 03 05 001 460 04 05 12881 01	177
05.020.1910.660	002 460 48 05 002 460 47 05 24244 01	177
05.020.1910.680	617 460 34 05 617 460 24 05 617 460 20 05 24276 01	177
05.020.1910.730	625 460 25 05 12925 01	177
05.020.1910.740	668 460 21 05 668 460 22 05 13575 01	87
05.020.1910.750	970 460 07 05 970 460 09 05 24239 01	178
05.020.1910.760	670 460 20 05 670 460 16 05 670 460 08 05 670 460 12 05 12931 01	87
05.020.1910.810	670 460 28 05 670 460 29 05 12934 01	88
05.020.1910.820	673 460 07 05 673 460 09 05 673 460 03 05 673 460 05 05 11476 01	178
05.020.1911.440	002 460 60 05 003 460 41 05 002 460 59 05 27628 01	178
05.020.1911.450	974 460 11 05 974 460 13 05 26024 01	178
05.020.1911.460	375 460 06 05 375 460 11 05 34003 01	179
05.020.1911.530	972 460 18 05 003 460 59 05 972 460 20 05 25154 01	179
05.020.1911.540	357 460 14 05 357 460 15 05 13554 01	36

aufsteigend nach Templin-Nr. | ascending to Templin-No.

T-Nr. T-No.	Vergl.-Nr. Comp.-No.	Seite page
05.020.1911.550	002 460 52 05 003 460 40 05 002 460 51 05 27954 01	179
05.020.1911.560	000 460 98 05 000 460 99 05 20892 01	179
05.020.1911.570	357 460 10 05 357 460 11 05 12898 01	37
05.020.1911.580	974 460 10 05 974 460 12 05 25821 01	180
05.020.1911.590	001 460 69 05 000 460 93 05 000 460 92 05 21412 01	180
05.020.1911.620	002 460 50 05 003 460 56 05 002 460 49 05 25447 01	180
05.020.1911.640	667 460 15 05 667 460 17 05 24911 01	88
05.020.1911.650	002 460 05 05 001 460 13 05 003 460 32 05 001 460 14 05 25249 01	180
05.020.1911.660	002 460 04 05 003 460 31 05 001 460 11 05 25250 01	181
05.020.1911.670	620 460 29 05 620 460 30 05 620 460 04 05 620 460 08 05 12923 01	181
05.020.1911.690	002 460 46 05 003 460 50 05 002 460 45 05 25721 01	181
05.020.1911.710	001 460 71 05 000 460 95 05 23470 01	181
05.020.1911.760	437 460 01 05 425 460 01 05 425 460 02 05 425 460 03 05 425 460 04 05 437 460 00 05 13563 01	182

T-Nr. T-No.	Vergl.-Nr. Comp.-No.	Seite page
05.020.1911.790	8.226.355.0000 8.226.280.0000 8.226.280.000 B 8.226.280.000 C 626 460 00 05 23391 01	37, 60
05.020.1911.840	410 330 05 03 410 330 03 03 8.226.308.000 8.226.308.000 C 8.226.381.000 21540 01 23386 01	60
05.020.1911.870	356 460 02 05 357 460 22 05 24292 01	37
05.020.1911.880	628 460 12 05 628 460 03 05 22077 01	37
05.020.1911.890	001 460 70 05 001 460 07 05 001 460 08 05 23476 01	182
05.020.1911.900	628 460 11 05 628 460 02 05 37680 01	38
05.020.1911.910	667 460 16 05 667 460 18 05 24581 01	88
05.020.1911.920	676 460 19 05 676 460 21 05 18447 01	182
05.020.1911.960	406 460 07 05 406 460 06 05 406 460 03 05 13559 01	182
05.020.1911.980	000 460 44 05 625 460 50 05 19695 01	183
05.020.1912.170	000 460 43 05 625 460 48 05 19694 01	183
05.020.1912.180	002 460 12 05 001 460 61 05 24309 01	183
05.020.1912.190	001 460 81 05 001 460 51 05 24303 01	183
05.020.1912.220	001 460 86 05 001 460 87 05 24304 01	184

T-Nr. T-No.	Vergl.-Nr. Comp.-No.	Seite page
05.020.1912.250	001 460 90 05 001 460 91 05 24305 01	184
05.020.1912.260	002 460 13 05 001 460 89 05 24310 01	184
05.020.1912.290	000 460 66 05 19929 01	184
05.020.1912.490	357 460 32 05 357 460 25 05 24302 01	38
05.020.1912.500	357 460 24 05 357 460 31 05 24301 01	38
05.020.1912.520	676 460 31 05 24231 01	185
05.020.1912.540	667 460 07 05 667 460 10 05 24210 01	88
05.020.1912.640	970 460 08 05 970 460 10 05 24240 01	185
05.020.1912.740	001 460 98 05 001 460 99 05 002 460 64 05 23469 01	185
05.020.1912.810	002 460 76 05 002 460 75 05 002 460 17 05 31150 01	185
05.020.1912.850	628 460 19 05 33306 01	38, 61
05.020.1912.860	002 460 62 05 002 460 61 05 003 460 42 05 25361 01	186
05.020.1913.210	002 460 86 05 002 460 87 05 25500 01	186
05.020.1913.220	002 460 06 05 24307 01	186
05.020.1913.240	002 460 92 05 002 460 93 05 003 460 45 05 31149 01	186
05.020.1913.250	003 460 60 05 972 460 19 05 972 460 21 05 26021 01	187

T-Nr. T-No.	Vergl.-Nr. Comp.-No.	Seite page
05.020.1913.260	001 460 15 05 001 460 73 05 003 460 33 05 375 460 16 05 29799 01	187
05.020.1913.280	970 460 11 05 972 460 28 05 21673 01	187
05.020.1913.290	974 460 05 05 974 460 09 05 24195 01	187
05.020.1913.300	001 460 49 05 001 460 74 05 24201 01	188
05.020.1913.330	002 460 24 05 002 460 30 05 24313 01	188
05.020.1913.340	002 460 25 05 002 460 31 05 24314 01	188
05.020.1913.350	002 460 53 05 002 460 54 05 24316 01	188
05.020.1913.360	972 460 06 05 26020 01	189
05.020.1913.370	974 460 00 05 974 460 06 05 26023 01	189
05.020.1913.380	974 460 15 05 24198 01	189
05.020.1913.390	002 460 88 05 002 460 89 05 25499 01	189
05.020.1913.400	003 460 18 05 003 460 19 05 003 460 58 05 35331 01	190
05.020.1913.410	976 460 04 05 35806 01 26026 01	190
05.020.1980.990	972 460 14 05 972 460 16 05 24241 01	190
05.020.3001.131	1 788 520 1 393 383 21448 01	219
05.020.3001.132	1 386 620 23500 01	219
05.020.3001.150	390 784 11932 01	219

aufsteigend nach Templin-Nr. | ascending to Templin-No.

T-Nr. T-No.	Vergl.-Nr. Comp.-No.	Seite page	T-Nr. T-No.	Vergl.-Nr. Comp.-No.	Seite page
05.020.3001.190	278 665 278 666 11928 01	220	05.020.3040.550	1 385 764 1 765 376 23505 01	222
05.020.3001.650	1 394 884 25139 02 25139 01	220	05.020.3040.560	1 385 765 1 765 377 23506 01	223
05.020.3001.720	1 897 669 481 217 21450 01	53	05.020.3040.570	1 385 766 1 765 378 23507 01	223
05.020.3040.000	1 912 757 1 847 311 1 768 898 1 384 025 1 379 071 1 356 055 111 294 14824 02	220	05.020.3040.580	1 511 600 1 759 692 29389 01	223
05.020.3040.010	1 912 758 1 847 312 1 769 597 1 384 027 1 379 072 21009 02	220	05.020.3040.590	1 399 758 1 765 380 29391 01	223
05.020.3040.040	1 343 262 25074 02 25074 01	221	05.020.3040.600	1 421 981 1 765 382 35441 01	224
05.020.3040.060	1 759 690 1 343 266 21456 01	221	05.020.3040.610	1 385 763 1 765 375 23504 01	224
05.020.3040.120	1 759 691 1 343 283 21455 01	221	05.020.3040.620	1 399 757 1 765 379 29390 01	224
05.020.3040.130	2 007 278 1 732 635 1 343 264 23493 01	221	05.020.3040.640	1 423 007 1 765 384 35306 01	224
05.020.3040.140	2 007 274 1 343 278 23494 01	222	05.020.3040.650	1 491 273 1 413 978 21444 01	225
05.020.3040.210	1 897 671 481 690 21449 01	53	05.020.3040.670	1 733 471 1 747 467 2 007 279 36655 01	225
05.020.3040.220	1 895 858 1 755 498 1 479 122 28970 01	54	05.020.4002.240	20 393 069 3988 704 1075 663 111 302 19663 01	236
05.020.3040.350	1 895 860 1 755 502 1 450 364 29388 01	54	05.020.4002.241	9522 701 29814 01	72
05.020.3040.530	1 386 618 1 788 522 23502 01	222	05.020.4002.242	20 777 411 5010 647 033 5010 647 032 5001 868 389 33583 01	208, 236
			05.020.4002.243	20 367 555 26778 01	237
			05.020.4002.250	1626 751 1610 338 11969 02	237



T-Nr. T-No.	Vergl.-Nr. Comp.-No.	Seite page
05.020.4002.270	1606 283 1576 092 11965 01	237
05.020.4002.280	1075 005 19521 01	237
05.020.4002.290	20 393 061 3988 697 3988 695 1075 153 22791 01	238
05.020.4002.300	6790 572 12147 02	238
05.020.4002.330	1592 940 11942 01	238
05.020.4002.360	20 393 059 8156 657 3988 698 3988 700 23553 01 23534 01	238
05.020.4002.370	85 114 200 1628 636 19884 01	239
05.020.4002.400	1197 338 11953 02	73
05.020.4002.550	1197 339 25364 01	73
05.020.4002.570	20 400 944 1071 344 11949 01	239
05.020.4002.580	20 393 075 1629 397 25010 01	239
05.020.4002.600	20 400 909 3124 480 6791 948 6777 855 18475 01	239
05.020.4002.640	20 497 800 9959 153 3112 122 21271 01	73
05.020.4002.680	6799 190 19686 01	240
05.020.4004.700	3116 050 19553 01	73
05.020.4004.710	1592 939 11941 01	240

T-Nr. T-No.	Vergl.-Nr. Comp.-No.	Seite page
05.020.4004.720	1071 170 22548 01	240
05.020.4004.730	20 745 923 20 490 123 9519 278 22024 02	74
05.020.4004.740	24 425 658 20 513 949 20 442 111 20 393 089 25439 01	240
05.020.4004.760	20 393 063 1075 664 3988 701 19873 01	241
05.020.4004.770	20 393 079 1628 635 3988 710 3988 708 23523 01	241
05.020.4004.820	24 425 662 20 442 115 20 513 953 20 393 093 3199 225 25441 01	241
05.020.4004.830	20 393 186 20 375 555 3986 452 37458 01	241
05.020.4004.880	1080 786 27716 01	242
05.020.4004.900	1071 169 21986 01	242
05.020.4004.910	1075 006 19889 01	242
05.020.4004.920	20 393 083 1088 985 24382 01	242
05.020.4004.930	85 104 265 3098 294 23568 01	74
05.020.4004.940	6799 189 20890 01	243
05.020.4004.950	1626 670 19883 01	243
05.020.4004.980	1626 672 1194 824 23538 01	74, 243

aufsteigend nach Templin-Nr. | ascending to Templin-No.

T-Nr. T-No.	Vergl.-Nr. Comp.-No.	Seite page	T-Nr. T-No.	Vergl.-Nr. Comp.-No.	Seite page
05.020.4004.990	21 252 480 20 374 831 37978 01 30948 01	243	05.020.4007.076	20 453 064 20 584 291 34698 01	247
05.020.4007.007	20 393 071 8190 146 8147 293 22792 01	244	05.020.4007.077	20 393 077 20 428 433 1088 988 25253 01	247
05.020.4007.009	20 393 073 8190 147 19689 01	244	05.020.4007.078	20 442 109 20 513 947 24 425 654 25438 01	247
05.020.4007.010	24 425 660 25440 01	244	05.020.4007.079	20 390 746 21 106 968 31965 01	247
05.020.4007.018	21 308 024 20 745 924 20 490 120 9519 279 21572 02 21572 01	74	05.020.4007.081	22 159 761 37231 01 35533 01	248
05.020.4007.023	20 497 799 9959 152 3112 273 21272 01	75	05.020.4007.083	22 159 757 37234 01 36735 01	248
05.020.4007.027	21 106 952 20 393 187 21 406 952 28091 01	244	05.020.4007.084	20 709 844 5010 488 167 25720 02 25720 01	208, 248
05.020.4007.032	85 114 187 1071 316 23547 01	245	05.020.4007.085	20 818 840 5010 305 365 5010 630 255 35593 01	208, 248
05.020.4007.033	21 106 936 20 390 745 27647 01	245	05.020.4251.500	5010 130 344 18990 02 18990 01	208
05.020.4007.070	20 393 067 3988 767 25255 01	245	05.020.4251.530	5010 294 287 24590 01	209
05.020.4007.071	20 393 065 3988 764 3988 766 25789 01	245	05.020.4251.540	5010 630 617 5010 294 289 5010 557 217 37237 01	209
05.020.4007.072	20 375 787 21 106 933 26779 01	246	05.020.4251.550	5010 294 288 24592 01	209
05.020.4007.073	20 453 063 31885 01	246	05.020.4251.560	5010 393 579 5010 206 705 5031 278 59 24613 01	19
05.020.4007.074	1088 987 19526 01	246	05.020.4256.000	5010 557 243 5010 060 764 19857 01	209
05.020.4007.075	20 581 632 31886 01	246	05.020.4256.001	7421 560 825 5010 630 637 5001 868 374 5010 630 638 33578 01	210



T-Nr. T-No.	Vergl.-Nr. Comp.-No.	Seite page
05.020.4256.190	5010 557 523 5010 383 203 5010 488 836 27677 01	210
05.020.4256.370	5010 294 720 27477 02	210
05.030.0275.720	1399 725 648 637 20565 01	112
05.030.0280.030	067 303 0067 303 11607 01	112
05.030.0280.040	067 389 0067 389 11608 01	112
05.030.0280.110	ACU 9240 19568 01	113
05.030.0280.111	1603 788 1604 105 34310 01	113
05.030.0280.112	000 463 26 29 000 463 23 29 1299 555 1201.104.04 22536 01	113, 190
05.030.0280.113	1344 684 20605 01	113
05.030.0280.120	ACU 9239 ACU 9232 19567 01	114
05.030.0280.160	1399 724 19783 01	114
05.030.0280.180	1689 604 AMPA 346 468 8941 716 7757 856 5366 858 2332 11721 01	114, 129
05.030.0280.190	1689 605 AMPA 345 468 8942 858 2333 1101 9669 19821 01	49, 114, 129
05.030.0280.210	1361 618 223 712 4253 2294 4210 5474 82.95301.0009 624 460 03 48 634 203 870 18461 01 31708 01	67, 115, 129, 154, 191

T-Nr. T-No.	Vergl.-Nr. Comp.-No.	Seite page
05.030.0280.220	1389 190 81.95301.6270 23763 01	28, 115, 155
05.030.0280.280	1315 878 6.851.529.000 22535 01	61, 115
05.030.0280.300	1401 942 AFRA 635	115
05.030.0280.360	1604 248	116
05.030.0280.370	1604 247	116
05.030.0280.500	1401 944	116
05.030.0610.330	02.180.812.00 2.205.0003.00 6.851.490.000 120322300 19614 01	11, 13, 15
05.030.0780.003	1142 071 41142071 19633 01	70
05.030.0803.430	4253 8047 4253 0316 9315 7156 5001 823 718 25073 01	129, 210
05.030.0803.660	9380 7545 9380 2242 9380 7320 9380 4061 35016 01 11639 01	82
05.030.0803.710	5 0030 9296 5 0034 0769 22806 01	130
05.030.0906.610	81.95301.6263 699 460 16 48 11572 01	155, 191

aufsteigend nach Templin-Nr. | ascending to Templin-No.

T-Nr. T-No.	Vergl.-Nr. Comp.-No.	Seite page	T-Nr. T-No.	Vergl.-Nr. Comp.-No.	Seite page
05.030.0907.019	81.95301.6351	21, 29, 39, 49,	05.030.0907.029	81.95301.6350	30, 40, 50, 55,
	81.95301.6275	54, 61, 75, 117,		81.95301.6308	62, 76, 118, 131,
	81.95301.6348	130, 155, 191,		81.95301.6274	156, 192, 212,
	81.95301.6309	211, 225, 249		81.95301.6049	226, 250
	81.95301.6311			81.95301.6278	
	81.95301.6050			81.95301.6242	
	81.95301.6254			81.95301.6112	
	81.95301.6152			81.95301.0084	
	81.95301.0083			81.95301.6284	
	81.95301.6279			81.95301.6252	
	90.80410.2730			81.95301.6126	
	81.95301.6125			81.95301.6234	
	81.95301.6285			81.95301.6178	
	81.95301.6253			81.95301.6048	
	81.95301.6177			81.95301.0075	
	81.95301.6237			81.95301.6224	
	81.95301.6179			81.95301.6168	
	81.95301.0102			81.95301.6061	
	81.95301.6157			81.95301.6154	
	81.95301.6181			81.95301.0016	
	81.95301.6223			81.95301.6030	
	81.95301.6091			81.95301.6043	
	81.95301.6029			81.95301.6090	
	81.95301.6044			81.95301.6053	
	90.80410.2273			81.95301.6143	
	81.95301.0015			81.95301.6108	
	81.95301.6087			4253 7936	
	81.95301.6107			81.95301.6156	
	81.95301.6120			81.95301.6149	
	81.95301.6155			81.95301.6194	
	81.95301.6054			001 460 77 48	
	001 460 36 48			001 460 22 48	
	002 460 03 48			001 460 12 48	
	001 460 78 48			001 460 08 48	
	001 460 23 48			000 460 29 48	
	001 460 03 48			000 460 28 48	
	000 460 34 48			000 460 10 48	
	001 460 14 48			000 460 03 48	
	000 460 06 48			000 460 89 48	
	000 460 35 48			001 460 02 48	
	000 460 12 48			001 460 18 48	
	1611 088			1603 789	
	1329 134			1618 048	
	1228 115			1257 890	
	1142 021			1326 861	
	696 225			1228 110	
	696 205			1142 022	
	607 053			698 450	
	1 738 380			696 226	
	1 358 792			609 643	
	395 009			607 981	
	283 783			1 358 793	
	0483 3830			069 752	
	0480 2444			1 914 427	
	0819 0225			1 767 328	
	4248 9574			1 738 381	
	4248 9395			395 010	
	4249 1957			283 784	
	0298 4061			0483 3829	
	5001 832 581			4248 3386	
	5000 288 361			0480 2443	
	0003 401 170			0812 2752	
	8.226.236.058			81.95301.6310	
	6.851.485.000			0296 9808	
	122353201			0296 6252	
	120325200			81.95301.0094	
	N1011020299			0483 3822	
	634 301 300			9319 4576	
	20 742 129			4248 8269	
	11492 03			4248 9573	
	11492 02			4249 1638	
	11390 01			4248 3388	
	11775 01			4248 9594	
	18020 01			5000 288 360	
	18481 01			5001 836 298	
	21008 01			5000 804 824	
	23120 01			5000 590 236	



T-Nr. T-No.	Vergl.-Nr. Comp.-No.	Seite page	
05.030.0907.029	7701 011 412	30, 40, 50, 55,	
	0003 406 261	62, 76, 118, 131,	
	0003 406 260	156, 192, 212,	
	0003 406 254	226, 250	
	0003 406 251		
	0003 406 236		
	0003 406 169		
	8.226.236.059		
	81.95301.6350		
	634 301 250		
	20 742 127		
	11505 03		
	11505 02		
	11389 01		
	11774 01		
	19620 01		
	20912 01		
	21007 01		
	05.030.0907.030	1101 9869	22, 131, 156
		9319 2809	
81.95301.6238			
82.95301.6015			
25165 01			
05.030.0907.130	1685 552	30, 40, 50, 118,	
	629 338 00 10	132, 157, 192,	
	4253 8384	212, 226, 250	
	81.95301.6286		
	7420 937 674		
	1 534 756		
	1 358 793		
	1 488 890		
	2 115 316		
	229872		
	25353 01		
	05.030.0907.200	1271 126	119, 157, 251
		4253 8048	
3099 128			
3090 291			
82.95301.6019			
81.95301.6268			
82.95301.6018			
30756 01			
05.030.0993.730		1 375 228	193, 227, 251
		81.95301.6095	
		81.95301.6071	
	000 460 49 48		
	000 463 46 29		
	1 912 759		
	1606 980		
	325 614		
	19537 01		
	25064 01		
	19862 01		
	23110 01		
	05.030.0993.860	81.95301.6271	31, 51, 119, 157,
		81.95301.6325	227
1 723 897			
2 051 041			
2 154 938			
2 154 939			
1785 340			
27853 01			

T-Nr. T-No.	Vergl.-Nr. Comp.-No.	Seite page	
05.030.0993.870	81.95301.6291	51, 132, 157	
	81.95301.6225		
	81.95301.6219		
	81.95301.6226		
	81.95301.6267		
	4253 3102		
	4253 3101		
	21075 01		
	05.030.0994.290	81.95301.6280	158
		82.95301.0010	
5001 849 879			
4253 3073			
000 996 48 45			
001 460 70 48			
1101 9859			
1 394 443			
33772 01			
05.030.1907.120		607 453	119, 132, 158,
		110 197	193, 213, 251
		1228 114	
		1373 135	
		607 451	
		1743 554	
		81.95301.6328	
		81.95301.6316	
		81.95301.6060	
		81.95301.6249	
	81.95301.6140		
	81.95301.6135		
	000 330 93 35		
	000 330 14 35		
	000 330 15 35		
	000 338 36 29		
	000 330 95 35		
	000 330 71 35		
	000 338 21 29		
	344 330 71 35		
5001 861 924			
0003 406 242			
5000 559 335			
5000 823 987			
1517 440			
1517 444			
1698 191			
11378 01			
05.030.1907.130	001 330 07 35	41, 89	
	001 330 09 35		
	000 330 27 35		
	000 330 70 35		
	30902 01		
	11405 01		
05.030.1907.140	001 330 08 35	41, 89	
	001 330 10 35		
	000 330 26 35		
	000 330 69 35		
	30903 01		
	11406 01		
	05.030.1907.150	001 330 03 35	193
001 330 04 35			
000 330 31 35			
000 330 81 35			
002 460 10 48			
11404 01			

aufsteigend nach Templin-Nr. | ascending to Templin-No.

T-Nr. T-No.	Vergl.-Nr. Comp.-No.	Seite page	T-Nr. T-No.	Vergl.-Nr. Comp.-No.	Seite page
05.030.1907.160	1743 594 1373 137 607 452 110 196 81.90685.0387 81.95301.6329 81.95301.6315 81.95301.0079 81.95301.6222 81.95301.6139 000 330 94 35 000 330 96 35 000 330 33 35 000 330 72 35 344 330 72 35 1517 279 1517 439 1695 511 1698 190 4248 4887 296 9507 483 3826 812 3394 819 3646 855 8536 5000 559 336 5000 823 947 5000 823 997 11379 01	41, 119, 133, 158, 193, 251	05.030.1907.190	81.95301.6322 81.95301.6304 81.95301.0078 81.95301.6141 81.95301.0076 85.40000.3301 81.90685.0388 000 330 86 35 000 330 88 35 000 330 07 35 000 330 68 35 000 330 02 35 5001 844 135 5000 807 553 5000 814 096 1517 448 0819 3649 4253 2543 4248 0023 11377 03 11377 01	133, 159, 194, 213, 252
05.030.1907.170	001 330 14 35 001 330 12 35 000 338 16 10 000 330 10 35 11407 01	89, 194			
05.030.1907.180	81.95301.6303 81.95301.6321 81.95301.6142 81.95301.6134 81.95301.0077 85.40000.3302 000 330 85 35 000 330 87 35 000 330 06 35 000 330 67 35 000 330 03 35 000 463 32 29 000 338 24 10 002 460 16 48 4249 1937 4248 0024 1518 142 1190 778 1517 449 5001 844 136 5000 814 097 0003 406 252 5000 807 554 608 530 11376 02 11376 01 19667 01	76, 97, 120, 133, 158, 194, 213, 252			



T-Nr. T-No.	Vergl.-Nr. Comp.-No.	Seite page	T-Nr. T-No.	Vergl.-Nr. Comp.-No.	Seite page
05.030.1907.209	1331 925	17, 31, 42, 62, 67, 120, 134, 159, 195, 214, 252	05.030.1907.210	001 330 21 35	42, 195
	1229 944			001 330 26 35	
	1326 896			000 330 40 35	
	1326 862			000 330 77 35	
	607 999	000 338 49 29			
	586 753	000 330 28 35			
	694 360	30904 01			
	694 298				
	698 609				
	069 514	05.030.1907.220		42, 195	
	1819 043	001 330 22 35			
	0483 3827	001 330 27 35			
	0812 2754	000 330 41 35			
	0296 6688	000 330 78 35			
	4248 5718	000 330 19 35			
	4249 3781	000 330 29 35			
	0298 0323	000 338 50 29			
	0483 3820	30905 01			
	6.851.517.000				
	81.95301.6272	05.030.1907.230		43, 89	
	81.95301.6360	000 460 85 48			
	81.95301.6250	000 460 45 48			
	81.95301.6319	000 460 41 48			
	81.95301.6162	310 330 13 35			
	81.95301.6282	000 330 50 35			
	81.95301.0064	310 330 08 35			
	81.95301.6239	000 463 11 29			
	81.95301.6065	310 330 04 35			
	82.95301.6014	000 460 21 48			
	81.95301.0068	11391 01			
	81.95301.0014				
	81.95301.6067	05.030.1907.410			90, 134, 196, 253
	81.95301.0042	000 330 98 35			
	81.95301.6073	001 330 00 35			
	90.80410.2218	000 330 13 35			
	81.95301.6056	000 330 76 35			
	001 330 01 35	008 338 00 29			
	001 330 02 35	1696 920			
	001 460 97 48	9319 4627			
	000 463 34 29	0855 8524			
	000 330 73 35	0798 4276			
	001 460 44 48	11381 01			
	000 463 22 29				
	001 460 34 48				
	000 330 58 35				
	000 330 32 35				
	000 330 02 48				
	000 338 34 10				
	000 330 17 35				
	082192300				
	11015686				
	5000 295 214				
	5000 812 483				
5000 242 159					
7701 016 946					
0003 406 253					
0003 406 212					
1697 247					
1695 690					
1696 057					
634301260					
11402 01					
25718 01					
24570 01					
23746 01					
23099 01					
21466 01					
21384 01					
19888 01					
11727 01					

aufsteigend nach Templin-Nr. | ascending to Templin-No.

T-Nr. T-No.	Vergl.-Nr. Comp.-No.	Seite page	T-Nr. T-No.	Vergl.-Nr. Comp.-No.	Seite page	
05.030.1907.549	81.95301.6361	31, 43, 51, 65,	05.030.1907.980	000 460 26 48	63, 121, 135,	
	81.95301.6273	120, 134, 159,		000 460 27 48	160, 196, 214	
	81.95301.6320	196, 214, 253		000 460 01 48		
	81.95301.6163			000 460 18 48		
	81.95301.6283			6.851.533.000		
	90.80415.3107			6.851.447.000		
	81.95301.0082			6.851.486.000		
	81.95301.0074			6.851.478.000		
	81.95301.6074			5000 808 458		
	81.95301.0013			7701 002 911		
	90.80410.2720			0298 0875		
	90.80410.2612			1142 173		
	81.95301.6068			1326 866		
	90.80410.2216			069 867		
	1338 714			608 000		
	1315 447			161 376		
	1319 838			81.95301.6151		
	311 300			90.80415.4117		
	607 998			81.95301.0025		
	0483 3828			11388 01		
	0298 4511					
	4249 3782					
	0812 2755			05.030.1910.440	001 460 05 48	196
	0298 0129			001 460 79 48		
	0483 3821			000 460 69 48		
	6.851.516.000			001 460 25 48		
	302 330 02 35			000 460 58 48		
	302 330 03 35			001 460 13 48		
	302 330 00 35			000 460 71 48		
	302 330 01 35			000 460 61 48		
	000 330 01 48			12280 04		
	001 330 88 35			12280 03		
	001 460 43 48					
	11015685			05.030.1910.700	001 460 76 48	43, 63, 160, 197
	82192200			001 460 17 48		
	82752400			001 460 11 48		
	5001 134 533			001 460 04 48		
	5000 295 336			000 460 68 48		
	0003 486 218			000 460 70 48		
	0003 406 218			000 460 87 48		
	5001 834 533			000 460 57 48		
	5001 859 984			000 460 60 48		
	5001 852 263			81.95301.6324		
	5000 295 215			11394 04		
	5001 850 550			11394 03		
	1698 839					
	1695 689			05.030.1910.880	000 338 49 23	197
0820 352 213		19822 01				
11403 01						
11728 01		05.030.1910.890	631 330 04 35	91, 197		
19675 01		12838 01				
21005 01						
21670 01		05.030.1910.920	310 330 20 35	44, 91		
23100 01		310 330 24 35				
23109 01		310 330 00 35				
24571 01		310 330 17 35				
		12836 01				
05.030.1907.770	601 330 04 35	90	05.030.1910.930	310 330 21 35	44, 91	
	601 330 06 35		310 330 25 35			
	601 330 53 35		310 330 01 35			
	000 463 10 29		310 330 16 35			
	11446 01		12837 01			
05.030.1907.780	601 330 05 35	90	05.030.1910.940	310 330 22 35	44, 91	
	601 330 07 35		310 330 26 35			
	601 330 52 35		310 330 02 35			
	11447 01		310 330 18 35			
	11447 02		19702 01			
05.030.1907.790	602 330 58 35	90				
	602 330 60 35					
	602 330 55 35					
	602 330 01 35					
	11452 01					



T-Nr. T-No.	Vergl.-Nr. Comp.-No.	Seite page
05.030.1910.950	310 330 23 35 310 330 27 35 310 330 03 35 310 330 19 35 19703 01	44, 92
05.030.1910.960	000 460 77 48 001 460 21 48 21296 01 21066 01	45
05.030.1910.970	000 460 78 48 001 460 20 48 21297 01	45
05.030.1910.980	000 460 17 48 81.95301.6297 6.851.491.000 2.205.0004.00 19615 01	160, 198
05.030.1912.610	001 460 51 48 001 460 86 48 001 460 38 48 001 460 48 48 27623 01	198
05.030.1912.621	001 460 85 48 001 460 42 48 001 460 50 48 23077 01	198
05.030.1912.780	001 460 15 48 001 460 16 48 002 460 06 48 5001 830 480 5001 845 430 33397 01	198, 215
05.030.1912.790	906 460 00 48 906 460 01 48 2E0 498 104 2E0 498 104 A 2E0 713 501 31148 01	92, 99
05.030.1980.770	631 320 02 28 631 320 00 28 608 320 01 28 608 320 00 28 000 320 01 28 000 320 00 28 11462 01	94, 200
05.030.1980.830	901 333 12 27 901 333 11 27 901 333 07 27 901 333 06 27 901 333 10 27 901 333 04 27 2D0 407 361 A 18875 03	94, 99
05.030.1980.840	631 338 03 10 12839 01	92, 199

T-Nr. T-No.	Vergl.-Nr. Comp.-No.	Seite page
05.030.1980.850	631 338 04 10 12840 01	92, 199
05.030.1980.860	000 330 97 35 000 330 12 35 000 330 75 35 631 330 05 35 000 338 35 29 000 330 99 35 000 338 34 29 1696 919 0855 8527 4248 7165 1203 240 01 1203 240 02 11380 01 19674 01 11380 02	51, 93, 135, 199, 253
05.030.1980.870	638 460 00 48 18874 03	93
05.030.1980.880	901 460 03 48 901 460 00 48 901 460 01 48 2D0 422 811 19719 02	93, 99
05.030.1980.900	631 338 05 10 001 330 48 35 460 330 12 35 460 330 04 35	93, 199
05.030.1980.970	81.95301.6276 81.95301.6251 81.95301.6184 001 330 18 35 000 340 12 07 0468 8948 5001 832 580 5001 831 481 0003 401 207	135, 161, 200, 215
05.030.1980.980	000 463 25 29 000 463 24 29 14982 01	200
05.030.3001.210	310 980 539 413	55, 227
05.030.3001.220	310 979	56, 227
05.030.3040.110	1 738 379 1 357 674 1603 883 81.95301.6288 5001 852 452 5001 858 763 000 460 52 48 20 894 438 41149875 21440 01 11393 01	70, 121, 161, 200, 215, 228
05.030.3040.510	1 394 447 34085 01	228

aufsteigend nach Templin-Nr. | ascending to Templin-No.

T-Nr. T-No.	Vergl.-Nr. Comp.-No.	Seite page	T-Nr. T-No.	Vergl.-Nr. Comp.-No.	Seite page
05.030.4002.411	1527 234 0382 745 1668 638 11954 01	77, 253	05.030.4004.840	21 263 974 3099 529 3097 228 22647 01	255
05.030.4002.412	20 994 563 20 739 867 20 321 617 70 314 325 29548 01	79	05.030.4007.017	3098 332 1698 047 1697 246 25552 01 19887 01	256
05.030.4002.420	20 710 008 31961 01	254	05.030.4007.030	8151 876 27632 01	256
05.030.4002.439	1698 847 1698 533 1507 822 6884 001 3092 471 3988 968 3090 728 1505 758 0366 757 11947 02	77, 254	05.030.4007.038	3093 647 27547 02	78, 256
05.030.4002.449	1698 846 1698 532 1507 823 3092 472 3988 965 3090 727 1505 759 0366 758 11946 02	77, 254	05.030.4007.041	3097 999 85 104 188 21687 01	256
05.030.4002.450	85 114 147 1698 840 1698 558 6869 744 6882 112 1131 744 11945 01 11945 02	77, 254	05.030.4007.042	3193 731 7403 193 731 28792 01	79, 215, 257
05.030.4002.460	6889 484 1699 401 1696 901 1131 742 11968 01	78, 255	05.030.4007.043	20 581 089 34527 01	257
05.030.4002.470	6889 483 1699 400 1696 900 1131 741 11967 01	78, 255	05.030.4007.044	20 374 698 27633 01	257
05.030.4002.480	85 114 146 1695 776 1698 557 1695 585 1507 826 11944 01 11944 02	78, 255	05.030.4007.046	3987 648 7403 987 648 27634 01	79, 216, 257
			05.050.0278.100	1375 507 542 0433 10	121
			05.050.0278.110	1291 227 367 352 526 663 7672.955.287 542 0014 10	70, 121
			05.050.0278.130	1797 644 1901 570 8695.671.117	122
			05.050.0884.000	4121 1223 8695.955.116	19, 22, 135
			05.050.0884.010	483 1152 7673.955.294	136



T-Nr. T-No.	Vergl.-Nr. Comp.-No.	Seite page
05.050.0916.100	81.47101.6122	161
	81.47101.6137	
	81.47101.6162	
	81.47101.6181	
	81.47101.9137	
	81.47101.9162	
	N1 01100 5183	
	7685 955 324	
	7685 955 180	
	542 0023 10	
05.050.0916.110	81.47101.6082	32, 161
	81.47101.6086	
	81.47101.6090	
	81.47101.6103	
	81.47101.6116	
	81.47101.6121	
	81.47101.6136	
	81.47101.6140	
	81.47101.6161	
	81.47101.6168	
	81.47101.6170	
	81.47101.6180	
	81.47101.9136	
	81.47101.9161	
	7685.955.325	
05.050.0916.120	81.47101.9189	162
	81.47101.6040	
	81.47101.6102	
	81.47101.6189	
	81.47101.6031	
	81.47101.6108	
	7685.955.359	
05.050.1915.030	001 460 30 80	45, 201
	001 460 51 80	
	002 460 07 80	
	002 460 08 80	
	002 460 39 80	
	003 460 19 80	
	003 460 50 80	
	8695.955.147	
05.050.1915.040	001 460 44 80	45, 201
	001 460 75 80	
	002 460 54 80	
	7685.955.246	
05.050.1915.050	002 460 15 80	201
	002 460 17 80	
	002 460 49 80	
	457 460 02 80	
	7685.955.253	
05.050.1915.060	001 460 31 80	46, 202
	003 460 51 80	
	542 0048 10	

T-Nr. T-No.	Vergl.-Nr. Comp.-No.	Seite page
05.050.1915.070	003 460 22 80	202
	003 460 49 80	
	002 460 88 80	
	002 460 89 80	
	8695.955.149	
05.050.1915.080	002 460 76 80	46, 202
	000 460 24 80	
	000 460 66 80	
	7684.955.198	
05.050.1915.090	000 460 94 80	46, 94, 202
	001 460 42 80	
	001 460 49 80	
	001 460 80 80	
	001 460 92 80	
	002 460 55 80	
	002 460 58 80	
7684.955.182		
05.050.1915.100	002 460 53 80	203
	001 460 85 80	
	7685.955.247	
05.050.1915.150	001 460 52 80	203
	002 460 41 80	
	003 460 21 80	
	8696.955.112	
05.050.1915.170	003 460 03 80	203
	003 460 52 80	
	003 460 55 80	
	542 0454 10	
05.050.1915.180	003 466 72 01	94
	003 466 71 01	
	7692 900 530	
	541 0231 10	
05.050.1915.190	003 466 07 01	95
	002 466 26 01	
	002 466 28 01	
	7692 900 504	
	542 0035 10	
05.050.1915.210	000 466 62 03	201
05.050.3005.100	1 333 790	56, 228
	1 422 417	
	1 439 958	
	1 457 710	
	1 571 397	
	571 436	
	542 0490 10	
542 0013 10		
05.050.3005.110	1 308 495	228
	1 457 708	
	1 421 272	
	571 434	
	542 0008 10	

T-Nr. T-No.	Vergl.-Nr. Comp.-No.	Seite page
05.050.3005.120	1 332 653 1 457 711 1 421 628 571 437 542 0012 10	56, 229
05.050.3005.130	1 324 223 1 421 273 1 457 709 571 435 542 0010 10	56, 229
05.050.3005.140	1 504 006 1 371 404	57, 229
05.050.4014.000	20 453 450 8694.974.519	79, 258
05.050.4014.010	85 000 031 3986 328 7403 986 328 7684.974.704	258
05.050.4014.020	20 453 453 20 482 481 21 188 993 24 424 074 85 000 768 85 000 972 85 103 704 85 114 316 7684.955.763	80, 258
05.050.4014.030	1589 925 5001 933 7673.955.202	80, 258
05.050.4014.040	1585 013 5001 934 8133 047 7673.955.211	80, 259
05.050.4014.050	3172 197 8112 963 8113 269 8159 831 542 0018 10	259
05.050.4014.060	85 103 705 85 114 317 24 424 075 85 000 769 85 000 973 7685 955 791	259

Vergl.-Nr. Comp.-No.	T-Nr. T-No.	Seite page
BPW		
02.180.812.00	05.030.0610.330	11
DAF		
067 303	05.030.0280.030	112
0067 303	05.030.0280.030	112
0067 389	05.030.0280.040	112
067 389	05.030.0280.040	112
069 514	05.030.1907.209	17, 120
069 752	05.030.0907.029	118
069 867	05.030.1907.980	121
094 006	05.020.0275.630	104
0094 006	05.020.0275.630	104
094 038	05.020.0275.600	104
094 613	05.020.0280.137	107
110 196	05.030.1907.160	119
110 197	05.030.1907.120	119
161 376	05.030.1907.980	121
223 712	05.030.0280.210	115
275 962	05.010.0280.320	102
311 300	05.030.1907.549	120
367 352	05.050.0278.110	121
525 433	05.020.0275.600	104
526 663	05.050.0278.110	121
554 765	05.020.0275.600	104
586 753	05.030.1907.209	17, 120
593 883	05.020.0275.690	104
607 053	05.030.0907.019	117
607 451	05.030.1907.120	119
607 452	05.030.1907.160	119
607 453	05.030.1907.120	119
607 981	05.030.0907.029	118
607 998	05.030.1907.549	120
607 999	05.030.1907.209	17, 120
608 000	05.030.1907.980	121
608 530	05.030.1907.180	120
609 643	05.030.0907.029	118
648 637	05.030.0275.720	112
694 298	05.030.1907.209	17, 120
694 360	05.030.1907.209	17, 120
696 205	05.030.0907.019	117
696 225	05.030.0907.019	117
696 226	05.030.0907.029	118
698 450	05.030.0907.029	118
698 609	05.030.1907.209	17, 120
890 992	05.020.0280.450	109
1142 021	05.030.0907.019	117
1142 022	05.030.0907.029	118

Vergl.-Nr. Comp.-No.	T-Nr. T-No.	Seite page
1142 173	05.030.1907.980	121
1228 110	05.030.0907.029	118
1228 114	05.030.1907.120	119
1228 115	05.030.0907.019	117
1229 944	05.030.1907.209	17, 120
1257 890	05.030.0907.029	118
1257 994	05.020.0280.135	106
1269 973	05.020.0280.430	109
1270 853	05.010.0280.050	101
1270 854	05.010.0275.700	101
1271 126	05.030.0907.200	119
1274 352	05.020.0280.430	109
1283 070	05.020.0280.130	105
1283 071	05.020.0280.130	105
1283 203	05.020.0275.590	103
1286 341	05.010.0280.380	102
1286 342	05.010.0280.320	102
1286 343	05.010.0269.990	101
1287 409	05.020.0280.135	106
1291 048	05.020.0280.260	108
1291 060	05.020.0275.610	104
1291 227	05.050.0278.110	121
1297 572	05.010.0280.310	102
1299 555	05.030.0280.112	113
1306 332	05.020.0280.470	109
1306 333	05.020.0280.810	111
1306 336	05.020.0280.138	107
1311 048	05.020.0280.800	111
1311 449	05.020.0280.132	105
1315 447	05.030.1907.549	120
1315 530	05.020.0280.130	105
1315 878	05.030.0280.280	115
1319 838	05.030.1907.549	120
1326 861	05.030.0907.029	118
1326 862	05.030.1907.209	17, 120
1326 866	05.030.1907.980	121
1326 896	05.030.1907.209	17, 120
1329 134	05.030.0907.019	117
1331 925	05.030.1907.209	17, 120
1337 644	05.010.0275.700	101
1338 714	05.030.1907.549	120
1344 684	05.030.0280.113	113
1351 205	05.010.0280.051	101
1351 525	05.020.0280.132	105
1351 722	05.020.0280.135	106
1351 723	05.020.0280.430	109
1351 730	05.020.0275.690	104
1351 731	05.020.0280.130	105

aufsteigend nach Vergleichs-Nr. | ascending to Comparison-No.

Vergl.-Nr. Comp.-No.	T-Nr. T-No.	Seite page
1351 734	05.020.0275.610	104
1351 735	05.020.0280.260	108
1351 737	05.020.0280.800	111
1351 739	05.020.0280.138	107
1351 740	05.020.0280.470	109
1351 741	05.020.0280.810	111
1351 742	05.020.0280.132	105
1351 745	05.020.0275.690	104
1353 391	05.010.0280.050	101
1353 395	05.010.0280.051	101
1353 396	05.010.0269.990	101
1361 155	05.010.0280.310	102
1361 618	05.030.0280.210	115
1363 858	05.020.0280.490	110
1363 859	05.020.0280.480	109
1373 135	05.030.1907.120	119
1373 137	05.030.1907.160	119
1375 507	05.050.0278.100	121
1385 487	05.020.0280.810	111
1385 488	05.020.0275.690	104
1385 498	05.020.0280.800	111
1385 499	05.020.0275.610	104
1385 500	05.020.0280.260	108
1385 502	05.020.0280.470	109
1385 506	05.020.0280.130	105
1385 509	05.020.0280.135	106
1385 511	05.020.0280.132	105
1385 516	05.020.0280.138	107
1389 190	05.030.0280.220	115
1395 993	05.020.0280.510	110
1395 994	05.020.0280.400	108
1395 995	05.020.0280.139	107
1395 999	05.020.0280.840	112
1396 000	05.020.0280.530	110
1399 724	05.030.0280.160	114
1399 725	05.030.0275.720	112
1401 937	05.020.0275.750	105
1401 940	05.020.0280.350	108
1401 942	05.030.0280.300	115
1401 944	05.030.0280.500	116
1401 946	05.020.0280.150	107
1405 499	05.020.0280.136	106
1405 655	05.020.0280.350	108
1406 025	05.020.0280.350	108
1406 038	05.020.0280.590	110
1406 600	05.020.0280.150	107
1407 144	05.020.0280.350	108

Vergl.-Nr. Comp.-No.	T-Nr. T-No.	Seite page
1426 101	05.020.0280.137 05.020.0280.390	107 108
1433 448	05.020.0280.134	106
1433 449	05.020.0280.131	105
1448 062	05.020.0280.490	110
1448 063	05.020.0280.480	109
1451 118	05.020.0280.820	111
1451 119	05.020.0280.830	111
1451 120	05.020.0280.134	106
1451 121	05.020.0280.131	105
1451 123	05.020.0280.133	106
1602 820	05.020.0280.490	110
1602 821	05.020.0280.480	109
1603 788	05.030.0280.111	113
1603 789	05.030.0907.029	118
1603 883	05.030.3040.110	121
1604 105	05.030.0280.111	113
1604 247	05.030.0280.370	116
1604 248	05.030.0280.360	116
1611 088	05.030.0907.019	117
1618 048	05.030.0907.029	118
1685 552	05.030.0907.130	118
1689 604	05.030.0280.180	114
1689 605	05.030.0280.190	114
1700 000	05.010.0280.580	103
1700 001	05.010.0280.540	102
1700 912	05.020.0280.350	108
1700 913	05.020.0280.150	107
1700 914	05.020.0280.590	110
1732 972	05.010.0280.900	103
1732 980	05.010.0280.910	103
1743 554	05.030.1907.120	119
1743 594	05.030.1907.160	119
1785 340	05.030.0993.860	119
1797 644	05.050.0278.130	122
1819 043	05.030.1907.209	17, 120
1901 570	05.050.0278.130	122
AMPA 345	05.030.0280.190	114
AMPA 346	05.030.0280.180	114
AFRA 635	05.030.0280.300	115
ACU 9232	05.030.0280.120	114
ACU 9239	05.030.0280.120	114
ACU 9240	05.030.0280.110	113
Irisbus		
4121 1223	05.050.0884.000	19
5031 278 59	05.020.4251.560	19
5 0314 0712	05.010.4256.150	19

Vergl.-Nr. Comp.-No.	T-Nr. T-No.	Seite page
5010 206 705	05.020.4251.560	19
5010 393 579	05.020.4251.560	19
Iveco		
0296 6252	05.030.0907.029	131
0296 6688	05.030.1907.209	134
296 9507	05.030.1907.160	133
0296 9808	05.030.0907.029	131
0298 0129	05.030.1907.549	134
0298 0323	05.030.1907.209	134
0298 0875	05.030.1907.980	135
0298 4061	05.030.0907.019	21, 130
0298 4511	05.030.1907.549	134
468 8941	05.030.0280.180	129
468 8942	05.030.0280.190	129
0468 8948	05.030.1980.970	135
0480 2443	05.030.0907.029	131
0480 2444	05.030.0907.019	21, 130
483 1152	05.050.0884.010	136
0483 3820	05.030.1907.209	134
0483 3821	05.030.1907.549	134
0483 3822	05.030.0907.029	131
483 3826	05.030.1907.160	133
0483 3827	05.030.1907.209	134
0483 3828	05.030.1907.549	134
0483 3829	05.030.0907.029	131
0483 3830	05.030.0907.019	21, 130
0485 4871	05.010.0803.390	125
0485 4874	05.020.0803.300	126
716 7757	05.030.0280.180	129
0798 4276	05.030.1907.410	134
0812 2752	05.030.0907.029	131
0812 2754	05.030.1907.209	134
0812 2755	05.030.1907.549	134
812 3394	05.030.1907.160	133
0813 1582	05.020.0803.320	126
0813 2397	05.020.0803.320	126
0813 5492	05.020.0803.760	128
813 5492	05.020.0803.760	128
0816 3773	05.010.0803.180	21, 125
0816 5309	05.010.0803.071	124
0819 0225	05.030.0907.019	21, 130
819 3646	05.030.1907.160	133
0819 3649	05.030.1907.190	133
0855 8524	05.030.1907.410	134
0855 8527	05.030.1980.860	135
855 8536	05.030.1907.160	133
856 5366	05.030.0280.180	129

Vergl.-Nr. Comp.-No.	T-Nr. T-No.	Seite page
858 2332	05.030.0280.180	129
858 2333	05.030.0280.190	129
4100 5309	05.010.0803.071	124
4100 5450	05.010.0803.180	21, 125
4100 5451	05.010.0803.180	21, 125
4100 5460	05.010.0803.071	124
4100 5463	05.020.0803.320	126
4100 5466	05.020.0803.400	127
4100 5469	05.020.0803.760	128
4100 5475	05.020.0803.470	127
4100 6093	05.020.0803.470	127
4101 1476	05.020.0803.760	128
4101 6960	05.020.0803.760	128
4101 6961	05.020.0803.760	128
4101 6964	05.020.0803.400	127
4102 8269	05.020.0803.460	127
4103 2608	05.010.0803.630	126
4103 3237	05.010.0803.630	126
4103 6943	05.010.0803.180	21, 125
4104 2749	05.020.0803.780	128
4104 2919	05.020.0803.320	126
4104 2938	05.010.0803.180	21, 125
4121 1223	05.050.0884.000	22, 135
4129 6162	05.010.0803.072	124
4210 5474	05.030.0280.210	129
4211 5532	05.010.0803.550	125
4211 8694	05.010.0803.550	125
4211 8782	05.010.0803.550	125
4248 0023	05.030.1907.190	133
4248 0024	05.030.1907.180	133
4248 3386	05.030.0907.029	131
4248 3388	05.030.0907.029	131
4248 4887	05.030.1907.160	133
4248 5718	05.030.1907.209	134
4248 7165	05.030.1980.860	135
4248 8269	05.030.0907.029	131
4248 9395	05.030.0907.019	21, 130
4248 9573	05.030.0907.029	131
4248 9574	05.030.0907.019	21, 130
4248 9594	05.030.0907.029	131
4249 1638	05.030.0907.029	131
4249 1937	05.030.1907.180	133
4249 1957	05.030.0907.019	21, 130
4249 3781	05.030.1907.209	134
4249 3782	05.030.1907.549	134
4253 0316	05.030.0803.430	129
4253 2294	05.030.0280.210	129
4253 2543	05.030.1907.190	133

aufsteigend nach Vergleichs-Nr. | ascending to Comparison-No.

Vergl.-Nr. Comp.-No.	T-Nr. T-No.	Seite page
4253 3101	05.030.0993.870	132
4253 3102	05.030.0993.870	132
4253 7936	05.030.0907.029	131
4253 8047	05.030.0803.430	129
4253 8384	05.030.0907.130	132
9315 7156	05.030.0803.430	129
9319 2809	05.030.0907.030	22, 131
9319 4576	05.030.0907.029	131
9319 4627	05.030.1907.410	134
9380 2242	05.030.0803.660	82
9380 4061	05.030.0803.660	82
9380 7320	05.030.0803.660	82
9380 7545	05.030.0803.660	82
9840 2544	05.020.0803.090	126
9840 2553	05.010.0803.070	124
9844 6354	05.020.0803.340	127
9844 9025	05.010.0803.540	125
9846 7459	05.020.0803.090	126
9846 9650	05.010.0803.540	125
5 0030 7556	05.010.0803.070	124
5 0030 9296	05.030.0803.710	130
5 0034 0769	05.030.0803.710	130
5 0039 7738	05.020.0803.770	128
5 0314 0712	05.010.4256.150	21
5 0403 4521	05.010.0803.074	124
5 0404 9893	05.020.0803.720	128
Kässbohrer		
6.851.490.000	05.030.0610.330	13
Lemförder		
11376 01	05.030.1907.180	76, 97, 120, 133, 158, 194, 213, 252
11376 02	05.030.1907.180	76, 97, 120, 133, 158, 194, 213, 252
11377 01	05.030.1907.190	133, 159, 194, 213, 252
11377 03	05.030.1907.190	133, 159, 194, 213, 252
11378 01	05.030.1907.120	119, 132, 158, 193, 213, 251
11379 01	05.030.1907.160	41, 119, 133, 158, 193, 251
11380 01	05.030.1980.860	51, 93, 135, 199, 253
11380 02	05.030.1980.860	51, 93, 135, 199, 253
11381 01	05.030.1907.410	90, 134, 196, 253
11388 01	05.030.1907.980	63, 121, 135, 160, 196, 214

Vergl.-Nr. Comp.-No.	T-Nr. T-No.	Seite page
11389 01	05.030.0907.029	30, 40, 50, 55, 62, 76, 118, 131, 156, 192, 212, 226, 250
11390 01	05.030.0907.019	21, 29, 39, 49, 54, 61, 75, 117, 130, 155, 191, 211, 225, 249
11391 01	05.030.1907.230	43, 89
11393 01	05.030.3040.110	70, 121, 161, 200, 215, 228
11394 03	05.030.1910.700	43, 63, 160, 197
11394 04	05.030.1910.700	43, 63, 160, 197
11402 01	05.030.1907.209	17, 31, 42, 62, 67, 120, 134, 159, 195, 214, 252
11403 01	05.030.1907.549	31, 43, 51, 65, 120, 134, 159, 196, 214, 253
11404 01	05.030.1907.150	193
11405 01	05.030.1907.130	41, 89
11406 01	05.030.1907.140	41, 89
11407 01	05.030.1907.170	89, 194
11417 03	05.020.1907.010	172
11435 01	05.020.1907.330	173
11438 01	05.020.1907.500	173
11439 01	05.010.1910.320	164
11446 01	05.030.1907.770	90
11447 01	05.030.1907.780	90
11447 02	05.030.1907.780	90
11448 01	05.020.1910.260	87
11449 02	05.010.1910.210	84
11450 01	05.010.1910.200	84
11452 01	05.030.1907.790	90
11454 01	05.020.1910.390	175
11457 01	05.020.1910.340	175
11460 01	05.020.1910.280	174
11462 01	05.030.1980.770	94, 200
11473 01	05.020.1910.240	86
11475 01	05.020.1910.330	174
11476 01	05.020.1910.820	178
11477 01	05.020.1910.430	175
11492 02	05.030.0907.019	21, 29, 39, 49, 54, 61, 75, 117, 130, 155, 191, 211, 225, 249
11492 03	05.030.0907.019	21, 29, 39, 49, 54, 61, 75, 117, 130, 155, 191, 211, 225, 249
11505 02	05.030.0907.029	30, 40, 50, 55, 62, 76, 118, 131, 156, 192, 212, 226, 250

Vergl.-Nr. Comp.-No.	T-Nr. T-No.	Seite page
11505 03	05.030.0907.029	30, 40, 50, 55, 62, 76, 118, 131, 156, 192, 212, 226, 250
11572 01	05.030.0906.610	155, 191
11607 01	05.030.0280.030	112
11608 01	05.030.0280.040	112
11639 01	05.030.0803.660	82
11721 01	05.030.0280.180	114, 129
11727 01	05.030.1907.209	17, 31, 42, 62, 67, 120, 134, 159, 195, 214, 252
11728 01	05.030.1907.549	31, 43, 51, 65, 120, 134, 159, 196, 214, 253
11765 01	05.020.0993.720	27
11766 01	05.020.0907.050	142
11768 01	05.010.0993.210	138
11770 01	05.010.0993.220	24, 48, 139
11774 01	05.030.0907.029	30, 40, 50, 55, 62, 76, 118, 131, 156, 192, 212, 226, 250
11775 01	05.030.0907.019	21, 29, 39, 49, 54, 61, 75, 117, 130, 155, 191, 211, 225, 249
11928 01	05.020.3001.190	220
11932 01	05.020.3001.150	219
11941 01	05.020.4004.710	240
11942 01	05.020.4002.330	238
11944 01	05.030.4002.480	78, 255
11944 02	05.030.4002.480	78, 255
11945 01	05.030.4002.450	77, 254
11945 02	05.030.4002.450	77, 254
11946 02	05.030.4002.449	77, 254
11947 02	05.030.4002.439	77, 254
11949 01	05.020.4002.570	239
11953 02	05.020.4002.400	73
11954 01	05.030.4002.411	77, 253
11965 01	05.020.4002.270	237
11967 01	05.030.4002.470	78, 255
11968 01	05.030.4002.460	78, 255
11969 02	05.020.4002.250	237
12147 02	05.020.4002.300	238
12280 03	05.030.1910.440	196
12280 04	05.030.1910.440	196
12836 01	05.030.1910.920	44, 91
12837 01	05.030.1910.930	44, 91
12838 01	05.030.1910.890	91, 197
12839 01	05.030.1980.840	92, 199
12840 01	05.030.1980.850	92, 199

Vergl.-Nr. Comp.-No.	T-Nr. T-No.	Seite page
12841 01	05.010.1910.770	85
12843 01	05.010.1910.590	85
12845 01	05.010.1910.780	85
12865 01	05.010.1910.230	34, 164
12877 01	05.010.1911.680	85
12879 01	05.010.1910.370	165
12881 01	05.020.1910.650	177
12898 01	05.020.1911.570	37
12905 01	05.020.1907.340	173
12923 01	05.020.1911.670	181
12925 01	05.020.1910.730	177
12931 01	05.020.1910.760	87
12933 01	05.020.1910.250	87
12934 01	05.020.1910.810	88
12935 01	05.020.1910.610	176
12936 01	05.020.1910.600	175
13550 01	05.010.1912.600	35
13554 01	05.020.1911.540	36
13556 01	05.010.1912.420	168
13557 01	05.020.1907.390	173
13559 01	05.020.1911.960	182
13560 01	05.010.1912.460	169
13563 01	05.020.1911.760	182
13575 01	05.020.1910.740	87
14824 02	05.020.3040.000	220
14982 01	05.030.1980.980	200
15107 01	05.020.0280.390	108
17802 01	05.020.0993.250	144
18020 01	05.030.0907.019	21, 29, 39, 49, 54, 61, 75, 117, 130, 155, 191, 211, 225, 249
18054 01	05.020.0803.400	127
18376 01	05.020.0993.670	148
18427 01	05.010.1912.580	34
18446 01	05.010.1910.380	34, 165
18447 01	05.020.1911.920	182
18448 01	05.010.1910.790	166
18461 01	05.030.0280.210	67, 115, 129, 154, 191
18475 01	05.020.4002.600	239
18481 01	05.030.0907.019	21, 29, 39, 49, 54, 61, 75, 117, 130, 155, 191, 211, 225, 249
18493 01	05.010.1911.810	59
18494 01	05.010.1911.800	59
18499 01	05.020.0993.940	150
18874 03	05.030.1980.870	93
18875 03	05.030.1980.830	94, 99

aufsteigend nach Vergleichs-Nr. | ascending to Comparison-No.

Vergl.-Nr. Comp.-No.	T-Nr. T-No.	Seite page
18919 01	05.020.0993.690	148
18977 01	05.020.0803.300	126
18990 01	05.020.4251.500	208
18990 02	05.020.4251.500	208
19339 01	05.020.0803.090	126
19521 01	05.020.4002.280	237
19526 01	05.020.4007.074	246
19537 01	05.030.0993.730	193, 227, 251
19539 01	05.010.4007.014	232
19553 01	05.020.4004.700	73
19567 01	05.030.0280.120	114
19568 01	05.030.0280.110	113
19588 01	05.020.0280.130	105
19606 01	05.020.0993.420	145
19607 01	05.020.0993.280	145
19614 01	05.030.0610.330	11, 13, 15
19615 01	05.030.1910.980	160, 198
19616 01	05.010.0994.590	59
19620 01	05.030.0907.029	30, 40, 50, 55, 62, 76, 118, 131, 156, 192, 212, 226, 250
19621 01	05.020.0803.320	126
19633 01	05.030.0780.003	70
19663 01	05.020.4002.240	236
19667 01	05.030.1907.180	76, 97, 120, 133, 158, 194, 213, 252
19674 01	05.030.1980.860	51, 93, 135, 199, 253
19675 01	05.030.1907.549	31, 43, 51, 65, 120, 134, 159, 196, 214, 253
19686 01	05.020.4002.680	240
19689 01	05.020.4007.009	244
19694 01	05.020.1912.170	183
19695 01	05.020.1911.980	183
19699 01	05.020.1910.630	176
19702 01	05.030.1910.940	44, 91
19703 01	05.030.1910.950	44, 92
19719 02	05.030.1980.880	93, 99
19721 01	05.010.1912.700	170
19783 01	05.030.0280.160	114
19785 01	05.020.0280.450	109
19821 01	05.030.0280.190	49, 114, 129
19822 01	05.030.1910.880	197
19857 01	05.020.4256.000	209
19862 01	05.030.0993.730	193, 227, 251
19866 01	05.010.3040.160	53, 205, 219
19866 02	05.010.3040.160	53, 205, 219
19873 01	05.020.4004.760	241

Vergl.-Nr. Comp.-No.	T-Nr. T-No.	Seite page
19882 01	05.010.4007.013	232
19882 02	05.010.4007.013	232
19883 01	05.020.4004.950	243
19884 01	05.020.4002.370	239
19887 01	05.030.4007.017	256
19888 01	05.030.1907.209	17, 31, 42, 62, 67, 120, 134, 159, 195, 214, 252
19889 01	05.020.4004.910	242
19904 01	05.020.1910.620	176
19929 01	05.020.1912.290	184
19947 01	05.010.1912.330	167
19989 02	05.020.0803.340	127
19995 01	05.010.0993.270	139
20396 01	05.020.0993.470	146
20397 01	05.010.1912.590	169
20410 01	05.010.0993.810	25
20423 01	05.010.0803.540	125
20430 01	05.010.1912.690	170
20565 01	05.030.0275.720	112
20581 01	05.010.4002.390	231
20592 01	05.020.0993.380	145
20593 01	05.010.0280.050	101
20605 01	05.030.0280.113	113
20889 01	05.010.0993.410	140
20890 01	05.020.4004.940	243
20892 01	05.020.1911.560	179
20898 01	05.010.1912.400	86
20912 01	05.030.0907.029	30, 40, 50, 55, 62, 76, 118, 131, 156, 192, 212, 226, 250
20913 01	05.020.0993.900	27
20991 01	05.020.0993.430	146
21001 01	05.020.0993.640	26
21005 01	05.030.1907.549	31, 43, 51, 65, 120, 134, 159, 196, 214, 253
21007 01	05.030.0907.029	30, 40, 50, 55, 62, 76, 118, 131, 156, 192, 212, 226, 250
21008 01	05.030.0907.019	21, 29, 39, 49, 54, 61, 75, 117, 130, 155, 191, 211, 225, 249
21009 02	05.020.3040.010	220
21010 01	05.010.3001.120	218
21014 01	05.010.0993.450	140
21066 01	05.030.1910.960	45
21075 01	05.030.0993.870	51, 132, 157
21270 01	05.010.4002.620	72

Vergl.-Nr. Comp.-No.	T-Nr. T-No.	Seite page
21271 01	05.020.4002.640	73
21272 01	05.020.4007.023	75
21282 01	05.010.0993.260	139
21285 01	05.010.0803.180	21, 125
21296 01	05.030.1910.960	45
21297 01	05.030.1910.970	45
21384 01	05.030.1907.209	17, 31, 42, 62, 67, 120, 134, 159, 195, 214, 252
21385 01	05.010.0803.070	124
21408 01	05.020.0993.440	146
21412 01	05.020.1911.590	180
21440 01	05.030.3040.110	70, 121, 161, 200, 215, 228
21444 01	05.020.3040.650	225
21448 01	05.020.3001.131	219
21449 01	05.020.3040.210	53
21450 01	05.020.3001.720	53
21455 01	05.020.3040.120	221
21456 01	05.020.3040.060	221
21466 01	05.030.1907.209	17, 31, 42, 62, 67, 120, 134, 159, 195, 214, 252
21469 01	05.020.0993.600	26, 36
21479 01	05.010.4007.011	231
21540 01	05.020.1911.840	60
21542 01	05.020.0280.470	109
21543 01	05.020.0280.810	111
21572 01	05.020.4007.018	74
21572 02	05.020.4007.018	74
21592 01	05.010.0280.310	102
21670 01	05.030.1907.549	31, 43, 51, 65, 120, 134, 159, 196, 214, 253
21673 01	05.020.1913.280	187
21687 01	05.030.4007.041	256
21770 01	05.020.0280.135	106
21784 01	05.020.0275.690	104
21804 01	05.010.0280.320	102
21805 01	05.010.0269.990	101
21807 01	05.010.0275.700	34, 69, 101
21986 01	05.020.4004.900	242
22024 02	05.020.4004.730	74
22058 01	05.020.0993.770	27, 149
22077 01	05.020.1911.880	37
22083 01	05.010.3001.120	218
22296 01	05.020.0275.610	104
22334 01	05.010.0780.017	69
22361 01	05.010.0780.016	69

Vergl.-Nr. Comp.-No.	T-Nr. T-No.	Seite page
22418 01	05.010.1911.750	167
22535 01	05.030.0280.280	61, 115
22536 01	05.030.0280.112	113, 190
22544 01	05.010.0993.820	25
22548 01	05.020.4004.720	240
22647 01	05.030.4004.840	255
22704 01	05.010.0993.610	24, 48
22791 01	05.020.4002.290	238
22792 01	05.020.4007.007	244
22794 01	05.010.4007.011	231
22806 01	05.030.0803.710	130
22807 01	05.010.1912.670	169
22822 01	05.010.4002.390	231
23077 01	05.030.1912.621	198
23099 01	05.030.1907.209	17, 31, 42, 62, 67, 120, 134, 159, 195, 214, 252
23100 01	05.030.1907.549	31, 43, 51, 65, 120, 134, 159, 196, 214, 253
23109 01	05.030.1907.549	31, 43, 51, 65, 120, 134, 159, 196, 214, 253
23110 01	05.030.0993.730	193, 227, 251
23120 01	05.030.0907.019	21, 29, 39, 49, 54, 61, 75, 117, 130, 155, 191, 211, 225, 249
23234 01	05.010.0280.240	69
23238 01	05.010.0280.380	102
23255 01	05.010.0803.550	125
23265 01	05.010.0994.550	142
23268 01	05.020.0994.130	151
23270 01	05.010.0993.920	141
23275 01	05.010.0993.700	25, 140
23304 01	05.020.0994.140	151
23305 01	05.010.0993.400	140
23307 01	05.010.0993.910	25, 141
23316 01	05.010.3001.910	218
23332 01	05.020.0280.430	109
23333 01	05.020.0275.590	103
23334 01	05.020.0280.260	108
23336 01	05.020.0280.138	107
23337 01	05.020.0280.800	111
23338 01	05.020.0280.132	105
23372 01	05.020.0803.470	127
23377 01	05.020.0803.760	128
23386 01	05.020.1911.840	60
23391 01	05.020.1911.790	37, 60
23405 01	05.020.0993.660	147
23407 01	05.020.0993.880	149

aufsteigend nach Vergleichs-Nr. | ascending to Comparison-No.

Vergl.-Nr. Comp.-No.	T-Nr. T-No.	Seite page
23417 01	05.020.0993.650	147
23419 01	05.020.0994.030	150
23428 01	05.020.0994.120	28, 151
23464 02	05.020.0993.620	147
23466 01	05.020.0993.930	150
23469 01	05.020.1912.740	185
23470 01	05.020.1911.710	181
23476 01	05.020.1911.890	182
23493 01	05.020.3040.130	221
23494 01	05.020.3040.140	222
23495 01	05.010.3001.620	53, 218
23495 02	05.010.3001.620	53, 218
23500 01	05.020.3001.132	219
23502 01	05.020.3040.530	222
23504 01	05.020.3040.610	224
23505 01	05.020.3040.550	222
23506 01	05.020.3040.560	223
23507 01	05.020.3040.570	223
23522 01	05.010.4002.390	231
23523 01	05.020.4004.770	241
23534 01	05.020.4002.360	238
23538 01	05.020.4004.980	74, 243
23547 01	05.020.4007.032	245
23553 01	05.020.4002.360	238
23568 01	05.020.4004.930	74
23746 01	05.030.1907.209	17, 31, 42, 62, 67, 120, 134, 159, 195, 214, 252
23763 01	05.030.0280.220	28, 115, 155
23962 01	05.010.1913.480	86, 171
23970 01	05.010.1912.370	168
23972 01	05.010.1913.500	171
23977 01	05.010.1911.510	166
23988 01	05.010.1910.520	165
23989 01	05.010.1912.430	169
23990 01	05.010.1912.940	170
23992 01	05.010.1912.350	168
23994 01	05.010.1911.740	167
23995 01	05.010.1913.430	170
23996 01	05.010.1912.380	168, 231
23997 01	05.010.1910.310	164
23998 01	05.010.1913.510	172
24008 01	05.010.4256.150	19, 21
24120 01	05.020.0994.150	152
24123 01	05.020.0993.760	149
24126 01	05.020.0994.160	28, 152
24195 01	05.020.1913.290	187
24198 01	05.020.1913.380	189

Vergl.-Nr. Comp.-No.	T-Nr. T-No.	Seite page
24201 01	05.020.1913.300	188
24210 01	05.020.1912.540	88
24231 01	05.020.1912.520	185
24239 01	05.020.1910.750	178
24240 01	05.020.1912.640	185
24241 01	05.020.1980.990	190
24242 01	05.020.1910.241	174
24243 01	05.020.1910.640	176
24244 01	05.020.1910.660	177
24276 01	05.020.1910.680	177
24292 01	05.020.1911.870	37
24301 01	05.020.1912.500	38
24302 01	05.020.1912.490	38
24303 01	05.020.1912.190	183
24304 01	05.020.1912.220	184
24305 01	05.020.1912.250	184
24307 01	05.020.1913.220	186
24309 01	05.020.1912.180	183
24310 01	05.020.1912.260	184
24311 01	05.010.1913.460	171
24313 01	05.020.1913.330	188
24314 01	05.020.1913.340	188
24315 01	05.010.1910.310	164
24316 01	05.020.1913.350	188
24380 01	05.020.0993.750	148
24382 01	05.020.4004.920	242
24570 01	05.030.1907.209	17, 31, 42, 62, 67, 120, 134, 159, 195, 214, 252
24571 01	05.030.1907.549	31, 43, 51, 65, 120, 134, 159, 196, 214, 253
24581 01	05.020.1911.910	88
24590 01	05.020.4251.530	209
24592 01	05.020.4251.550	209
24613 01	05.020.4251.560	19
24816 01	05.010.0280.240	69
24911 01	05.020.1911.640	88
25010 01	05.020.4002.580	239
25064 01	05.030.0993.730	193, 227, 251
25073 01	05.030.0803.430	129, 210
25074 01	05.020.3040.040	221
25074 02	05.020.3040.040	221
25099 01	05.020.0907.260	143
25099 02	05.020.0907.260	143
25100 02	05.020.0993.480	147
25139 01	05.020.3001.650	220
25139 02	05.020.3001.650	220
25154 01	05.020.1911.530	179

Vergl.-Nr. Comp.-No.	T-Nr. T-No.	Seite page
25165 01	05.030.0907.030	22, 131, 156
25175 01	05.010.0803.390	125
25213 01	05.020.0907.280	143
25249 01	05.020.1911.650	180
25250 01	05.020.1911.660	181
25253 01	05.020.4007.077	247
25255 01	05.020.4007.070	245
25272 01	05.020.0993.890	150
25276 01	05.010.0993.204	138
25318 01	05.010.0803.071	124
25353 01	05.030.0907.130	30, 40, 50, 118, 132, 157, 192, 212, 226, 250
25361 01	05.020.1912.860	186
25364 01	05.020.4002.550	73
25394 01	05.020.0994.110	151
25395 01	05.010.0993.330	24, 139
25438 01	05.020.4007.078	247
25439 01	05.020.4004.740	240
25440 01	05.020.4007.010	244
25441 01	05.020.4004.820	241
25447 01	05.020.1911.620	180
25459 01	05.010.1910.450	84
25499 01	05.020.1913.390	189
25500 01	05.020.1913.210	186
25552 01	05.030.4007.017	256
25629 01	05.020.0993.630	26, 48
25630 01	05.020.0993.780	27, 49
25717 01	05.020.0907.280	143
25718 01	05.030.1907.209	17, 31, 42, 62, 67, 120, 134, 159, 195, 214, 252
25720 01	05.020.4007.084	208, 248
25720 02	05.020.4007.084	208, 248
25721 01	05.020.1911.690	181
25789 01	05.020.4007.071	245
25821 01	05.020.1911.580	180
26020 01	05.020.1913.360	189
26021 01	05.020.1913.250	187
26023 01	05.020.1913.370	189
26024 01	05.020.1911.450	178
26026 01	05.020.1913.410	190
26064 01	05.010.4007.028	72, 232
26679 01	05.020.0803.460	127
26778 01	05.020.4002.243	237
26779 01	05.020.4007.072	246
26784 01	05.010.1912.930	36
26826 01	05.020.0280.400	108
26828 01	05.020.0280.830	111

Vergl.-Nr. Comp.-No.	T-Nr. T-No.	Seite page
26829 01	05.020.0280.133	106
26830 01	05.020.0280.137 05.020.0280.390	107 108
26831 01	05.020.0280.510	110
26832 01	05.020.0280.840	112
26833 01	05.020.0280.530	110
26841 01	05.020.0280.480	109
26843 01	05.020.0280.134	106
26916 01	05.020.0993.460	146
27441 01	05.020.1910.242	174
27456 02	05.010.4256.320	206
27477 02	05.020.4256.370	210
27547 02	05.030.4007.038	78, 256
27574 02	05.010.3040.160	53, 205, 219
27623 01	05.030.1912.610	198
27628 01	05.020.1911.440	178
27632 01	05.030.4007.030	256
27633 01	05.030.4007.044	257
27634 01	05.030.4007.046	79, 216, 257
27647 01	05.020.4007.033	245
27656 01	05.020.0803.770	128
27673 01	05.020.0994.170	152
27677 01	05.020.4256.190	210
27683 01	05.020.1907.250	172
27716 01	05.020.4004.880	242
27756 01	05.010.1910.460	84, 99
27849 01	05.010.0994.060	26, 48
27850 01	05.010.0280.051	101
27853 01	05.030.0993.860	31, 51, 119, 157, 227
27874 01	05.010.4007.012	231
27892 01	05.010.0803.630	126
27893 01	05.010.4007.062	233
27954 01	05.020.1911.550	179
28091 01	05.020.4007.027	244
28328 01	05.020.0907.220	143
28330 01	05.020.0993.790	149
28331 01	05.020.0907.210	143
28766 01	05.010.0994.180	141
28791 01	05.010.4007.064	233
28792 01	05.030.4007.042	79, 215, 257
28956 01	05.020.0994.190	152
28970 01	05.020.3040.220	54
29388 01	05.020.3040.350	54
29389 01	05.020.3040.580	223
29390 01	05.020.3040.620	224
29391 01	05.020.3040.590	223
29438 01	05.010.4256.330	207, 236
29451 01	05.010.4256.350	207

aufsteigend nach Vergleichs-Nr. | ascending to Comparison-No.

Vergl.-Nr. Comp.-No.	T-Nr. T-No.	Seite page	Vergl.-Nr. Comp.-No.	T-Nr. T-No.	Seite page
29453 01	05.010.4256.350	207	33398 01	05.010.1910.201	164
29454 01	05.010.4256.310	206	33416 02	05.020.0803.720	128
29548 01	05.030.4002.412	79	33574 01	05.010.4251.501	205, 235
29614 01	05.010.4007.031	232	33575 01	05.010.4256.133	206, 235
29799 01	05.020.1913.260	187	33576 01	05.010.4256.132	206, 235
29814 01	05.020.4002.241	72	33577 01	05.010.4256.131	205, 235
29950 01	05.010.4256.350	207	33578 01	05.020.4256.001	210
29954 01	05.010.4256.360	207	33583 01	05.020.4002.242	208, 236
30078 01	05.010.0803.074	124	33772 01	05.030.0994.290	158
30290 01	05.020.0280.490	110	33978 01	05.010.0280.900	103
30478 01	05.010.1910.530	165	33979 01	05.010.0280.910	103
30585 01	05.020.0993.680	148	33980 01	05.010.0280.580	103
30592 01	05.020.0907.280	143	33981 01	05.010.0280.540	102
30593 01	05.020.0993.340	145	33982 01	05.020.0280.139	107
30756 01	05.030.0907.200	119, 157, 251	33998 01	05.010.0993.500	24
30902 01	05.030.1907.130	41, 89	34003 01	05.020.1911.460	179
30903 01	05.030.1907.140	41, 89	34025 01	05.020.0275.750	105
30904 01	05.030.1907.210	42, 195	34028 01	05.020.0280.136	106
30905 01	05.030.1907.220	42, 195	34034 01	05.020.0280.350	108
30906 01	05.020.1907.760	36	34035 01	05.020.0280.150	107
30908 01	05.020.1907.640	86	34036 01	05.020.0280.590	110
30911 01	05.020.1907.070	172	34085 01	05.030.3040.510	228
30912 01	05.020.1910.280	174	34310 01	05.030.0280.111	113
30948 01	05.020.4004.990	243	34527 01	05.030.4007.043	257
30998 01	05.020.0280.131	105	34528 01	05.010.4007.063	233
31148 01	05.030.1912.790	92, 99	34590 01	05.020.0994.270	153
31149 01	05.020.1913.240	186	34591 01	05.020.0993.242	144
31150 01	05.020.1912.810	185	34592 01	05.020.0993.243	144
31313 01	05.020.0994.250	153	34593 01	05.020.0994.280	153
31539 01	05.010.4007.067	234	34594 01	05.010.0994.520	142
31708 01	05.030.0280.210	67, 115, 129, 154, 191	34595 01	05.010.0994.530	142
31773 01	05.010.0993.201	138	34696 01	05.010.4007.068	205, 234
31882 01	05.010.0993.202	138	34698 01	05.020.4007.076	247
31883 01	05.010.3001.920	218	35016 01	05.030.0803.660	82
31885 01	05.020.4007.073	246	35306 01	05.020.3040.640	224
31886 01	05.020.4007.075	246	35331 01	05.020.1913.400	190
31895 01	05.020.0993.241	144	35333 01	05.010.4007.065	72, 234
31930 01	05.020.0994.260	153	35441 01	05.020.3040.600	224
31937 01	05.020.0280.820	111	35508 01	05.020.0803.780	128
31956 01	05.010.4007.061	233	35513 01	05.010.0803.072	124
31961 01	05.030.4002.420	254	35532 01	05.010.4007.066	234
31965 01	05.020.4007.079	247	35533 01	05.020.4007.081	248
33303 01	05.010.1912.820	35, 59	35593 01	05.020.4007.085	208, 248
33304 01	05.010.1912.830	35, 60	35594 01	05.010.4256.340	207, 236
33305 01	05.010.1912.840	35, 60	35805 01	05.020.0994.560	154
33306 01	05.020.1912.850	38, 61	35806 01	05.020.1913.410	190
33397 01	05.030.1912.780	198, 215	35807 01	05.020.0994.580	154
			35809 01	05.010.0994.510	141

Vergl.-Nr. Comp.-No.	T-Nr. T-No.	Seite page
35811 01	05.020.0994.570	154
36540 01	05.010.1913.440	171
36655 01	05.020.3040.670	225
36735 01	05.020.4007.083	248
37222 01	05.010.4007.011	231
37223 01	05.010.4007.012	231
37224 01	05.010.4007.062	233
37225 01	05.010.4007.064	233
37227 01	05.010.4007.061	233
37228 01	05.010.4251.501	205, 235
37229 01	05.010.4256.133	206, 235
37230 01	05.010.4007.066	234
37231 01	05.020.4007.081	248
37232 01	05.010.0280.910	103
37233 01	05.010.4256.340	207, 236
37234 01	05.020.4007.083	248
37237 01	05.020.4251.540	209
37247 01	05.010.3001.120	218
37258 01	05.010.1913.440	171
37329 01	05.010.1911.630	167
37330 01	05.010.1911.520	166
37331 01	05.010.1912.940	170
37332 01	05.010.1910.830	166
37451 01	05.010.0269.990	101
37458 01	05.020.4004.830	241
37546 01	05.010.3001.920	218
37547 01	05.010.3001.620	53, 218
37679 01	05.010.1912.930	36
37680 01	05.020.1911.900	38
37978 01	05.020.4004.990	243
LuK		
541 0231 10	05.050.1915.180	94
542 0008 10	05.050.3005.110	228
542 0010 10	05.050.3005.130	56, 229
542 0012 10	05.050.3005.120	56, 229
542 0013 10	05.050.3005.100	56, 228
542 0014 10	05.050.0278.110	70, 121
542 0018 10	05.050.4014.050	259
542 0023 10	05.050.0916.100	161
542 0035 10	05.050.1915.190	95
542 0048 10	05.050.1915.060	46, 202
542 0433 10	05.050.0278.100	121
542 0454 10	05.050.1915.170	203
542 0490 10	05.050.3005.100	56, 228
MAN		
81.46610.6001	05.020.0993.280	145

Vergl.-Nr. Comp.-No.	T-Nr. T-No.	Seite page
81.46610.6159	05.020.0994.120	28, 151
81.46610.6200	05.020.0994.120	28, 151
81.46610.6275	05.020.0994.120	28, 151
81.46610.6281	05.020.0993.670	148
81.46610.6300	05.020.0993.670	148
81.46610.6301	05.020.0993.250	144
81.46610.6303	05.020.0993.670	148
81.46610.6304	05.020.0993.670	148
81.46610.6305	05.020.0993.250	144
81.46610.6313	05.020.0993.720	27
81.46610.6317	05.020.0994.120	28, 151
81.46610.6327	05.020.0993.670	148
81.46610.6328	05.020.0993.250	144
81.46610.6329	05.020.0993.670	148
81.46610.6333	05.020.0907.050	142
81.46610.6334	05.020.0907.050	142
81.46610.6354	05.020.0907.050	142
81.46610.6355	05.020.0907.050	142
81.46610.6360	05.020.0907.050	142
81.46610.6361	05.020.0907.050	142
81.46610.6374	05.020.0993.770	27, 149
81.46610.6375	05.020.0993.600	26
81.46610.6578	05.020.0993.940	150
81.46610.6654	05.020.0993.900	27
81.46610.6656	05.020.0993.420	145
81.46610.6659	05.020.0993.420	145
81.46610.6684	05.020.0993.600	26
81.46610.6691	05.020.0993.760	149
81.46610.6708	05.020.0993.640	26
81.46610.6720	05.020.0994.160	28, 152
81.46610.6721	05.020.0907.050	142
81.46610.6722	05.020.0907.050	142
81.46610.6723	05.020.0907.050	142
81.46610.6724	05.020.0993.280	145
81.46610.6725	05.020.0993.280	145
81.46610.6753	05.020.0993.430	146
81.46610.6754	05.020.0993.430	146
81.46610.6759	05.020.0994.150	152
81.46610.6761	05.020.0994.130	151
81.46610.6762	05.020.0994.130	151
81.46610.6767	05.020.0994.110	151
81.46610.6768	05.020.0994.110	151
81.46610.6771	05.020.0994.130	151
81.46610.6779	05.020.0993.380	145
81.46610.6780	05.020.0993.380	145
81.46610.6782	05.020.0993.380	145
81.46610.6790	05.020.0993.930	150
81.46610.6791	05.020.0993.930	150

aufsteigend nach Vergleichs-Nr. | ascending to Comparison-No.

Vergl.-Nr. Comp.-No.	T-Nr. T-No.	Seite page
81.46610.6792	05.020.0994.150	152
81.46610.6793	05.020.0994.150	152
81.46610.6794	05.020.0993.780	27
81.46610.6796	05.020.0994.150	152
81.46610.6798	05.020.0993.940	150
81.46610.6876	05.020.0993.940	150
81.46611.6004	05.020.0993.460	146
81.46611.6005	05.020.0993.460	146
81.46611.6006	05.020.0993.420	145
81.46611.6013	05.020.0993.760	149
81.46611.6014	05.020.0994.110	151
81.46611.6016	05.020.0993.600	26
81.46611.6019	05.020.0993.770	27, 149
81.46611.6044	05.020.0993.780	27
81.46611.6045	05.020.0993.630	26
81.46611.6061	05.020.0993.900	27
81.46611.6063	05.020.0993.720	27
81.46611.6064	05.020.0994.120	28, 151
81.46611.6067	05.020.0993.640	26
81.46611.6085	05.020.0993.780	27
81.46611.6087	05.020.0907.280	143
81.46611.6088	05.020.0907.280	143
81.46611.6096	05.020.0907.280	143
81.46611.6097	05.020.0907.280	143
81.46611.6099	05.020.0907.280	143
81.46611.6104	05.020.0993.340	145
81.46611.6105	05.020.0993.340	145
81.46611.6107	05.020.0993.340	145
81.46611.6114	05.020.0993.780	27
81.46611.6132	05.020.0907.280	143
81.46611.6133	05.020.0907.280	143
81.46611.6134	05.020.0993.340	145
81.46611.6135	05.020.0993.340	145
81.46611.6136	05.020.0907.280	143
81.46611.6137	05.020.0993.340	145
81.46611.6138	05.020.0993.680	148
81.46611.6139	05.020.0993.680	148
81.46611.6146	05.020.0994.270	153
81.46611.6147	05.020.0994.270	153
81.46611.6151	05.020.0907.210	143
81.46611.6152	05.020.0907.220	143
81.46611.6154	05.020.0993.243	144
81.46611.6155	05.020.0993.243	144
81.46611.6156	05.020.0993.243	144
81.46611.6157	05.020.0994.280	153
81.46611.6158	05.020.0994.280	153
81.46611.6159	05.020.0994.280	153
81.46611.6161	05.020.0907.220	143

Vergl.-Nr. Comp.-No.	T-Nr. T-No.	Seite page
81.46611.6162	05.020.0907.220	143
81.46611.6163	05.020.0907.220	143
81.46611.6174	05.020.0994.580	154
81.46611.6175	05.020.0994.580	154
81.46611.6176	05.020.0994.580	154
81.46611.6197	05.020.0907.280	143
81.46611.6198	05.020.0907.280	143
81.46611.6199	05.020.0993.340	145
81.46611.6200	05.020.0993.340	145
81.46611.6201	05.020.0993.680	148
81.46611.6202	05.020.0993.680	148
81.46611.6203	05.020.0993.680	148
81.46611.6204	05.020.0994.270	153
81.46611.6205	05.020.0907.280	143
81.46611.6206	05.020.0993.340	145
81.46611.6211	05.020.0994.120	28, 151
81.46611.6216	05.020.0907.050	142
81.46710.6080	05.010.0993.810	25
81.46710.6112	05.010.0993.210	138
81.46710.6118	05.010.0993.260	139
81.46710.6122	05.010.0993.220	24, 139
81.46710.6131	05.010.0993.270	139
81.46710.6134	05.010.0993.220	24, 139
81.46710.6136	05.010.0993.810	25
81.46710.6162	05.010.0993.260	139
81.46710.6163	05.010.0993.210	138
81.46710.6164	05.010.0993.260	139
81.46710.6165	05.010.0993.210	138
81.46710.6167	05.010.0993.220	24, 139
81.46710.6172	05.010.0993.810	25
81.46710.6189	05.010.0993.260	139
81.46710.6194	05.010.0993.220	24, 139
81.46710.6195	05.010.0993.220	24, 139
81.46710.6198	05.010.0993.210	138
81.46710.6265	05.010.0993.270	139
81.46710.6266	05.010.0993.270	139
81.46710.6280	05.020.0994.120	28, 151
81.46710.6295	05.010.0993.810	25
81.46710.6314	05.010.0993.700	25, 140
81.46710.6315	05.010.0993.700	25, 140
81.46710.6316	05.010.0993.700	25, 140
81.46710.6337	05.010.0993.810	25
81.46710.6345	05.010.0993.810	25
81.46710.6353	05.010.0993.210	138
81.46710.6354	05.010.0993.210	138
81.46710.6359	05.010.0993.270	139
81.46710.6360	05.010.0993.270	139
81.46710.6361	05.010.0993.210	138

Vergl.-Nr. Comp.-No.	T-Nr. T-No.	Seite page
81.46710.6362	05.010.0993.270	139
81.46710.6367	05.010.0993.260	139
81.46710.6368	05.010.0993.260	139
81.46710.6369	05.010.0993.260	139
81.46710.6378	05.010.0993.220	24, 139
81.46710.6379	05.010.0993.220	24, 139
81.46710.6380	05.010.0993.220	24, 139
81.46710.6388	05.010.0993.260	139
81.46710.6393	05.010.0993.260	139
81.46710.6394	05.010.0993.260	139
81.46710.6395	05.010.0993.270	139
81.46710.6396	05.010.0993.270	139
81.46710.6397	05.010.0993.270	139
81.46710.6418	05.020.0993.470	146
81.46710.6421	05.010.0993.810	25
81.46710.6434	05.020.0907.260	143
81.46710.6435	05.020.0907.260	143
81.46710.6436	05.020.0993.480	147
81.46710.6437	05.020.0993.480	147
81.46710.6438	05.020.0993.690	148
81.46710.6439	05.020.0993.690	148
81.46710.6442	05.020.0993.440	146
81.46710.6443	05.020.0993.440	146
81.46710.6451	05.010.0993.810	25
81.46710.6455	05.020.0993.480	147
81.46710.6456	05.020.0907.260	143
81.46710.6460	05.020.0993.440	146
81.46710.6815	05.010.0993.270	139
81.46710.6816	05.010.0993.270	139
81.46710.6830	05.010.0993.220	24, 139
81.46710.6836	05.010.0993.220	24, 139
81.46710.6851	05.010.0993.450	140
81.46710.6852	05.010.0993.450	140
81.46710.6853	05.010.0993.450	140
81.46710.6862	05.010.0993.500	24
81.46710.6863	05.010.0993.500	24
81.46710.6864	05.010.0993.500	24
81.46710.6865	05.010.0993.410	140
81.46710.6866	05.010.0993.410	140
81.46710.6876	05.010.0993.810	25
81.46710.6882	05.010.0993.810	25
81.46710.6891	05.010.0993.810	25
81.46710.6902	05.010.0993.820	25
81.46710.6903	05.010.0993.270	139
81.46710.6904	05.010.0993.270	139
81.46710.6909	05.010.0993.500	24
81.46710.6910	05.010.0993.500	24
81.46710.6911	05.010.0993.220	24, 139

Vergl.-Nr. Comp.-No.	T-Nr. T-No.	Seite page
81.46710.6912	05.010.0993.220	24, 139
81.46710.6918	05.010.0994.550	142
81.46710.6933	05.010.0993.910	25, 141
81.46710.6934	05.010.0993.910	25, 141
81.46710.6948	05.010.0993.270	139
81.46710.6953	05.010.0993.220	24, 139
81.46710.6961	05.020.0994.140	151
81.46710.6966	05.010.0993.920	141
81.46710.6974	05.010.0993.500	24
81.46710.6994	05.010.0993.400	140
81.46711.6579	05.010.0993.204	138
81.46711.6711	05.010.0993.910	25, 141
81.46711.6712	05.010.0993.500	24
81.46711.6714	05.010.0993.920	141
81.46711.6715	05.010.0993.610	24
81.46711.6719	05.010.0993.450	140
81.46711.6720	05.010.0993.204	138
81.46711.6721	05.020.0994.160	28, 152
81.46711.6722	05.010.0993.820	25
81.46711.6724	05.010.0993.270	139
81.46711.6725	05.010.0993.210	138
81.46711.6726	05.010.0993.400	140
81.46711.6728	05.010.0993.410	140
81.46711.6729	05.010.0993.450	140
81.46711.6730	05.010.0993.204	138
81.46711.6736	05.010.0993.220	24, 139
81.46711.6740	05.010.0994.550	142
81.46711.6743	05.010.0994.180	141
81.46711.6744	05.010.0994.180	141
81.46711.6745	05.020.0994.140	151
81.46711.6746	05.020.0994.140	151
81.46711.6747	05.010.0993.220	24, 139
81.46711.6762	05.010.0993.810	25
81.46711.6763	05.010.0993.810	25
81.46711.6764	05.010.0993.810	25
81.46711.6771	05.010.0994.060	26
81.46711.6773	05.010.0993.330	24, 139
81.46711.6786	05.010.0993.500	24
81.46711.6791	05.010.0993.330	24, 139
81.46711.6795	05.010.0993.270	139
81.46711.6801	05.010.0994.520	142
81.46711.6802	05.010.0993.201	138
81.46711.6803	05.010.0993.202	138
81.46711.6804	05.010.0993.201	138
81.46711.6808	05.010.0993.201	138
81.46711.6810	05.010.0994.180	141
81.46711.6818	05.010.0994.530	142
81.46711.6819	05.010.0994.530	142

aufsteigend nach Vergleichs-Nr. | ascending to Comparison-No.

Vergl.-Nr. Comp.-No.	T-Nr. T-No.	Seite page
81.46711.6820	05.010.0993.210	138
81.46711.6830	05.010.0993.220	24, 139
81.46711.6831	05.010.0993.204	138
81.46711.6838	05.020.0994.140	151
81.46711.6841	05.010.0993.450	140
81.46711.6845	05.010.0993.500	24
81.46711.6848	05.010.0993.330	24, 139
81.46711.6849	05.010.0993.210	138
81.46711.6853	05.010.0993.270	139
81.46711.6855	05.020.0994.260	153
81.46711.6856	05.020.0994.260	153
81.46711.6857	05.020.0994.260	153
81.46711.6858	05.010.0993.330	24, 139
81.46711.6859	05.010.0993.330	24, 139
81.46711.6860	05.010.0993.330	24, 139
81.46711.6861	05.010.0993.330	24, 139
81.46711.6862	05.010.0993.330	24, 139
81.46711.6863	05.010.0993.330	24, 139
81.46711.6864	05.010.0994.520	142
81.46711.6865	05.010.0994.520	142
81.46711.6869	05.010.0994.520	142
81.46711.6877	05.010.0994.060	26
81.46711.6878	05.010.0994.060	26
81.46711.6879	05.010.0994.060	26
81.46711.6884	05.010.0994.180	141
81.46711.6885	05.010.0994.180	141
81.46711.6887	05.010.0994.530	142
81.46711.6891	05.010.0993.201	138
81.46711.6892	05.010.0993.201	138
81.46711.6893	05.010.0993.202	138
81.46711.6894	05.010.0993.202	138
81.46711.6895	05.010.0993.201	138
81.46711.6896	05.010.0993.202	138
81.46711.6921	05.010.0993.330	24, 139
81.46711.6933	05.010.0994.510	141
81.46711.6934	05.010.0994.510	141
81.46711.6944	05.010.0994.180	141
81.46711.6950	05.020.0994.260	153
81.47101.6031	05.050.0916.120	162
81.47101.6040	05.050.0916.120	162
81.47101.6082	05.050.0916.110	32, 161
81.47101.6086	05.050.0916.110	32, 161
81.47101.6090	05.050.0916.110	32, 161
81.47101.6102	05.050.0916.120	162
81.47101.6103	05.050.0916.110	32, 161
81.47101.6108	05.050.0916.120	162
81.47101.6116	05.050.0916.110	32, 161
81.47101.6121	05.050.0916.110	32, 161

Vergl.-Nr. Comp.-No.	T-Nr. T-No.	Seite page
81.47101.6122	05.050.0916.100	161
81.47101.6136	05.050.0916.110	32, 161
81.47101.6137	05.050.0916.100	161
81.47101.6140	05.050.0916.110	32, 161
81.47101.6161	05.050.0916.110	32, 161
81.47101.6162	05.050.0916.100	161
81.47101.6168	05.050.0916.110	32, 161
81.47101.6170	05.050.0916.110	32, 161
81.47101.6180	05.050.0916.110	32, 161
81.47101.6181	05.050.0916.100	161
81.47101.6189	05.050.0916.120	162
81.47101.9136	05.050.0916.110	32, 161
81.47101.9137	05.050.0916.100	161
81.47101.9161	05.050.0916.110	32, 161
81.47101.9162	05.050.0916.100	161
81.47101.9189	05.050.0916.120	162
81.90685.0387	05.030.1907.160	158
81.90685.0388	05.030.1907.190	159
81.95301.0013	05.030.1907.549	31, 159
81.95301.0014	05.030.1907.209	31, 159
81.95301.0015	05.030.0907.019	29, 155
81.95301.0016	05.030.0907.029	30, 156
81.95301.0025	05.030.1907.980	160
81.95301.0042	05.030.1907.209	31, 159
81.95301.0064	05.030.1907.209	31, 159
81.95301.0068	05.030.1907.209	31, 159
81.95301.0074	05.030.1907.549	31, 159
81.95301.0075	05.030.0907.029	30, 156
81.95301.0076	05.030.1907.190	159
81.95301.0077	05.030.1907.180	158
81.95301.0078	05.030.1907.190	159
81.95301.0079	05.030.1907.160	158
81.95301.0082	05.030.1907.549	31, 159
81.95301.0083	05.030.0907.019	29, 155
81.95301.0084	05.030.0907.029	30, 156
81.95301.0094	05.030.0907.029	30, 156
81.95301.0102	05.030.0907.019	29, 155
81.95301.6029	05.030.0907.019	29, 155
81.95301.6030	05.030.0907.029	30, 156
81.95301.6043	05.030.0907.029	30, 156
81.95301.6044	05.030.0907.019	29, 155
81.95301.6048	05.030.0907.029	30, 156
81.95301.6049	05.030.0907.029	30, 156
81.95301.6050	05.030.0907.019	29, 155
81.95301.6053	05.030.0907.029	30, 156
81.95301.6054	05.030.0907.019	29, 155
81.95301.6056	05.030.1907.209	31, 159
81.95301.6060	05.030.1907.120	158

Vergl.-Nr. Comp.-No.	T-Nr. T-No.	Seite page
81.95301.6061	05.030.0907.029	30, 156
81.95301.6065	05.030.1907.209	31, 159
81.95301.6067	05.030.1907.209	31, 159
81.95301.6068	05.030.1907.549	31, 159
81.95301.6073	05.030.1907.209	31, 159
81.95301.6074	05.030.1907.549	31, 159
81.95301.6087	05.030.0907.019	29, 155
81.95301.6090	05.030.0907.029	30, 156
81.95301.6091	05.030.0907.019	29, 155
81.95301.6107	05.030.0907.019	29, 155
81.95301.6108	05.030.0907.029	30, 156
81.95301.6112	05.030.0907.029	30, 156
81.95301.6120	05.030.0907.019	29, 155
81.95301.6125	05.030.0907.019	29, 155
81.95301.6126	05.030.0907.029	30, 156
81.95301.6134	05.030.1907.180	158
81.95301.6135	05.030.1907.120	158
81.95301.6139	05.030.1907.160	158
81.95301.6140	05.030.1907.120	158
81.95301.6141	05.030.1907.190	159
81.95301.6142	05.030.1907.180	158
81.95301.6143	05.030.0907.029	30, 156
81.95301.6149	05.030.0907.029	30, 156
81.95301.6151	05.030.1907.980	160
81.95301.6152	05.030.0907.019	29, 155
81.95301.6154	05.030.0907.029	30, 156
81.95301.6155	05.030.0907.019	29, 155
81.95301.6156	05.030.0907.029	30, 156
81.95301.6157	05.030.0907.019	29, 155
81.95301.6162	05.030.1907.209	31, 159
81.95301.6163	05.030.1907.549	31, 159
81.95301.6168	05.030.0907.029	30, 156
81.95301.6177	05.030.0907.019	29, 155
81.95301.6178	05.030.0907.029	30, 156
81.95301.6179	05.030.0907.019	29, 155
81.95301.6181	05.030.0907.019	29, 155
81.95301.6184	05.030.1980.970	161
81.95301.6194	05.030.0907.029	30, 156
81.95301.6219	05.030.0993.870	157
81.95301.6222	05.030.1907.160	158
81.95301.6223	05.030.0907.019	29, 155
81.95301.6224	05.030.0907.029	30, 156
81.95301.6225	05.030.0993.870	157
81.95301.6226	05.030.0993.870	157
81.95301.6234	05.030.0907.029	30, 156
81.95301.6237	05.030.0907.019	29, 155
81.95301.6238	05.030.0907.030	156
81.95301.6239	05.030.1907.209	31, 159

Vergl.-Nr. Comp.-No.	T-Nr. T-No.	Seite page
81.95301.6242	05.030.0907.029	30, 156
81.95301.6249	05.030.1907.120	158
81.95301.6250	05.030.1907.209	31, 159
81.95301.6251	05.030.1980.970	161
81.95301.6252	05.030.0907.029	30, 156
81.95301.6253	05.030.0907.019	29, 155
81.95301.6254	05.030.0907.019	29, 155
81.95301.6263	05.030.0906.610	155
81.95301.6267	05.030.0993.870	157
81.95301.6268	05.030.0907.200	157
81.95301.6270	05.030.0280.220	28, 155
81.95301.6271	05.030.0993.860	31, 157
81.95301.6272	05.030.1907.209	31, 159
81.95301.6273	05.030.1907.549	31, 159
81.95301.6274	05.030.0907.029	30, 156
81.95301.6275	05.030.0907.019	29, 155
81.95301.6276	05.030.1980.970	161
81.95301.6278	05.030.0907.029	30, 156
81.95301.6279	05.030.0907.019	29, 155
81.95301.6280	05.030.0994.290	158
81.95301.6282	05.030.1907.209	31, 159
81.95301.6283	05.030.1907.549	31, 159
81.95301.6284	05.030.0907.029	30, 156
81.95301.6285	05.030.0907.019	29, 155
81.95301.6286	05.030.0907.130	30, 157
81.95301.6288	05.030.3040.110	161
81.95301.6291	05.030.0993.870	157
81.95301.6297	05.030.1910.980	160
81.95301.6303	05.030.1907.180	158
81.95301.6304	05.030.1907.190	159
81.95301.6308	05.030.0907.029	30, 156
81.95301.6309	05.030.0907.019	29, 155
81.95301.6310	05.030.0907.029	30, 156
81.95301.6311	05.030.0907.019	29, 155
81.95301.6315	05.030.1907.160	158
81.95301.6316	05.030.1907.120	158
81.95301.6319	05.030.1907.209	31, 159
81.95301.6320	05.030.1907.549	31, 159
81.95301.6321	05.030.1907.180	158
81.95301.6322	05.030.1907.190	159
81.95301.6324	05.030.1910.700	160
81.95301.6325	05.030.0993.860	31, 157
81.95301.6328	05.030.1907.120	158
81.95301.6329	05.030.1907.160	158
81.95301.6348	05.030.0907.019	29, 155
81.95301.6350	05.030.0907.029	30, 156
81.95301.6351	05.030.0907.019	29, 155
81.95301.6360	05.030.1907.209	31, 159

aufsteigend nach Vergleichs-Nr. | ascending to Comparison-No.

Vergl.-Nr. Comp.-No.	T-Nr. T-No.	Seite page
81.95301.6361	05.030.1907.549	31, 159
82.46610.6057	05.020.0994.170	152
82.46610.6147	05.020.0994.170	152
82.46610.6183	05.020.0907.220	143
82.46610.6184	05.020.0907.210	143
82.46610.6185	05.020.0907.210	143
82.46610.6186	05.020.0907.220	143
82.46610.6187	05.020.0907.220	143
82.46610.6191	05.020.0993.930	150
82.46710.6031	05.010.0994.550	142
82.95301.0009	05.030.0280.210	154
82.95301.0010	05.030.0994.290	158
82.95301.6014	05.030.1907.209	31, 159
82.95301.6015	05.030.0907.030	156
82.95301.6018	05.030.0907.200	157
82.95301.6019	05.030.0907.200	157
84.46610.6059	05.020.0993.640	26
85.40000.3301	05.030.1907.190	159
85.40000.3302	05.030.1907.180	158
85.46610.6005	05.020.0993.890	150
85.46610.6012	05.020.0993.650	147
85.46610.6018	05.020.0993.750	148
85.46610.6019	05.020.0993.880	149
85.46610.6021	05.020.0993.660	147
85.46610.6030	05.020.0993.280	145
85.46610.6032	05.020.0994.560	154
85.46610.6052	05.020.0994.030	150
85.46610.6056	05.020.0994.570	154
85.46610.6102	05.020.0993.280	145
85.46610.6103	05.020.0994.560	154
85.46610.6104	05.020.0993.430	146
85.46610.6105	05.020.0993.890	150
85.46610.6107	05.020.0993.620	147
85.46610.6112	05.020.0993.650	147
85.46610.6118	05.020.0993.750	148
85.46610.6119	05.020.0993.880	149
85.46610.6121	05.020.0993.660	147
85.46610.6123	05.020.0994.030	150
85.46610.6140	05.020.0993.660	147
85.46610.6141	05.020.0993.890	150
85.46610.6142	05.020.0993.650	147
85.46610.6143	05.020.0993.620	147
85.46610.6146	05.020.0994.030	150
85.46610.6147	05.020.0994.190	152
85.46610.6150	05.020.0993.880	149
85.46610.6152	05.020.0993.750	148
85.46610.6156	05.020.0993.790	149
85.46610.6160	05.020.0994.250	153

Vergl.-Nr. Comp.-No.	T-Nr. T-No.	Seite page
85.46610.6162	05.020.0993.241	144
85.46610.6163	05.020.0993.242	144
85.46610.6201	05.020.0993.280	145
85.46610.6202	05.020.0994.560	154
85.46610.6212	05.020.0993.650	147
85.46610.6218	05.020.0993.750	148
85.46610.6239	05.020.0994.030	150
85.46610.6246	05.020.0994.250	153
90.80410.2216	05.030.1907.549	31, 159
90.80410.2218	05.030.1907.209	31, 159
90.80410.2273	05.030.0907.019	29, 155
90.80410.2612	05.030.1907.549	31, 159
90.80410.2720	05.030.1907.549	31, 159
90.80410.2730	05.030.0907.019	29, 155
90.80415.3107	05.030.1907.549	31, 159
90.80415.4117	05.030.1907.980	160
Mercedes-Benz		
000 320 00 28	05.030.1980.770	94, 200
000 320 01 28	05.030.1980.770	94, 200
608 320 00 28	05.030.1980.770	94, 200
608 320 01 28	05.030.1980.770	94, 200
631 320 00 28	05.030.1980.770	94, 200
631 320 02 28	05.030.1980.770	94, 200
346 330 39 03	05.010.1910.310	164
346 330 40 03	05.010.1912.700	170
346 330 48 03	05.010.1912.700	170
346 330 49 03	05.010.1910.310	164
356 330 00 03	05.010.1912.600	35
356 330 01 03	05.010.1912.580	34
371 330 70 03	05.010.1910.320	164
382 330 04 03	05.010.1912.930	36
385 330 02 03	05.010.1912.420	168
385 330 05 03	05.010.1910.230	34, 164
385 330 06 03	05.010.1910.230	34, 164
385 330 08 03	05.010.1912.420	168
385 330 11 03	05.010.1910.230	34, 164
385 330 13 03	05.010.1912.590	169
385 330 14 03	05.010.1910.230	34, 164
385 330 15 03	05.010.1910.230	34, 164
385 330 16 03	05.010.1912.420	168
385 330 18 03	05.010.1912.420	168
385 330 21 03	05.010.1912.590	169
385 330 22 03	05.010.1912.590	169
385 330 24 03	05.010.1912.590	169
393 330 00 03	05.010.1910.320	164
393 330 02 03	05.010.1910.320	164
393 330 03 03	05.010.1910.320	164

Vergl.-Nr. Comp.-No.	T-Nr. T-No.	Seite page
393 330 04 03	05.010.1910.320	164
393 330 07 03	05.010.1910.320	164
405 330 01 03	05.010.1910.201	164
405 330 02 03	05.010.1910.201	164
416 330 00 03	05.010.1912.460	169
424 330 03 03	05.010.1912.370	168
602 330 00 03	05.010.1910.210	84
602 330 03 03	05.010.1910.210	84
602 330 04 03	05.010.1910.210	84
602 330 09 03	05.010.1910.200	84
602 330 10 03	05.010.1910.200	84
602 330 53 03	05.010.1910.200	84
602 330 54 03	05.010.1910.200	84
613 330 00 03	05.010.1912.600	35
613 330 01 03	05.010.1912.580	34
617 330 02 03	05.010.1911.750	167
617 330 03 03	05.010.1911.750	167
620 330 05 03	05.010.1912.330	167
620 330 06 03	05.010.1912.330	167
625 330 09 03	05.010.1912.690	170
625 330 12 03	05.010.1912.690	170
625 330 15 03	05.010.1912.350	168
625 330 16 03	05.010.1912.350	168
625 330 20 03	05.010.1912.670	169
625 330 21 03	05.010.1912.670	169
625 330 24 03	05.010.1912.350	168
625 330 25 03	05.010.1912.350	168
625 330 26 03	05.010.1912.670	169
625 330 27 03	05.010.1912.670	169
625 330 32 03	05.010.1910.310	164
628 330 01 03	05.010.1912.930	36
628 330 04 03	05.010.1912.830	35
628 330 05 03	05.010.1912.820	35
631 330 05 03	05.010.1910.770	85
631 330 06 03	05.010.1910.590	85
631 330 07 03	05.010.1910.770	85
667 330 03 03	05.010.1912.400	86
667 330 04 03	05.010.1912.400	86
667 330 05 03	05.010.1912.400	86
667 330 06 03	05.010.1912.400	86
669 330 04 03	05.010.1911.680	85
669 330 05 03	05.010.1911.680	85
669 330 06 03	05.010.1913.480	86, 171
669 330 07 03	05.010.1913.480	86, 171
670 330 00 03	05.010.1911.680	85
670 330 01 03	05.010.1911.680	85
670 330 02 03	05.010.1911.680	85
670 330 03 03	05.010.1911.680	85

Vergl.-Nr. Comp.-No.	T-Nr. T-No.	Seite page
670 330 06 03	05.010.1911.680	85
676 330 02 03	05.010.1910.370	165
676 330 03 03	05.010.1910.380	34, 165
676 330 04 03	05.010.1910.370	165
676 330 05 03	05.010.1910.380	34, 165
676 330 06 03	05.010.1913.500	171
676 330 07 03	05.010.1910.370	165
676 330 08 03	05.010.1910.380	34, 165
676 330 09 03	05.010.1910.370	165
676 330 10 03	05.010.1910.380	34, 165
676 330 13 03	05.010.1913.500	171
676 330 14 03	05.010.1913.500	171
677 330 03 03	05.010.1910.790	166
677 330 04 03	05.010.1910.790	166
941 330 00 03	05.010.1910.520	165
941 330 01 03	05.010.1910.520	165
941 330 02 03	05.010.1910.520	165
941 330 03 03	05.010.1910.520	165
941 330 05 03	05.010.1910.520	165
942 330 00 03	05.010.1910.830	166
942 330 01 03	05.010.1910.830	166
942 330 02 03	05.010.1910.830	166
942 330 03 03	05.010.1910.530	165
942 330 04 03	05.010.1910.530	165
942 330 05 03	05.010.1912.670	169
942 330 06 03	05.010.1912.670	169
942 330 07 03	05.010.1910.830	166
942 330 09 03	05.010.1912.670	169
942 330 10 03	05.010.1913.460	171
942 330 11 03	05.010.1910.830	166
942 330 16 03	05.010.1910.530	165
942 330 17 03	05.010.1913.460	171
942 330 21 03	05.010.1912.350	168
942 330 23 03	05.010.1910.830	166
942 330 24 03	05.010.1910.530	165
942 330 25 03	05.010.1913.460	171
944 330 02 03	05.010.1912.690	170
944 330 05 03	05.010.1910.310	164
944 330 17 03	05.010.1910.310	164
945 330 00 03	05.010.1911.630	167
945 330 01 03	05.010.1911.630	167
945 330 02 03	05.010.1912.430	169
945 330 03 03	05.010.1912.430	169
945 330 04 03	05.010.1911.630	167
945 330 05 03	05.010.1912.430	169
945 330 06 03	05.010.1911.630	167
945 330 09 03	05.010.1911.630	167
949 330 02 03	05.010.1912.350	168

aufsteigend nach Vergleichs-Nr. | ascending to Comparison-No.

Vergl.-Nr. Comp.-No.	T-Nr. T-No.	Seite page
949 330 03 03	05.010.1912.350	168
949 330 04 03	05.010.1911.520	166
949 330 05 03	05.010.1911.520	166
949 330 06 03	05.010.1912.940	170
949 330 07 03	05.010.1912.940	170
949 330 08 03	05.010.1911.520	166
949 330 09 03	05.010.1912.350	168
949 330 10 03	05.010.1911.740	167
949 330 11 03	05.010.1911.740	167
949 330 12 03	05.010.1913.430	170
949 330 13 03	05.010.1913.430	170
949 330 14 03	05.010.1911.520	166
949 330 15 03	05.010.1912.940	170
949 330 16 03	05.010.1912.940	170
949 330 17 03	05.010.1911.740	167
949 330 18 03	05.010.1913.430	170
949 330 21 03	05.010.1911.740	167
949 330 22 03	05.010.1913.430	170
949 330 23 03	05.010.1911.520	166
960 330 01 03	05.010.1913.440	171
970 330 00 03	05.010.1911.510	166
970 330 01 03	05.010.1911.510	166
970 330 02 03	05.010.1911.510	166
970 330 03 03	05.010.1911.510	166
970 330 04 03	05.010.1911.510	166
975 330 00 03	05.010.1913.510	172
975 330 02 03	05.010.1912.380	168
975 330 04 03	05.010.1913.510	172
975 330 10 03	05.010.1913.510	172
975 330 19 03	05.010.1913.510	172
000 330 02 35	05.030.1907.190	194
000 330 03 35	05.030.1907.180	194
000 330 06 35	05.030.1907.180	194
000 330 07 35	05.030.1907.190	194
000 330 10 35	05.030.1907.170	89, 194
000 330 12 35	05.030.1980.860	93, 199
000 330 13 35	05.030.1907.410	90, 196
000 330 14 35	05.030.1907.120	193
000 330 15 35	05.030.1907.120	193
000 330 17 35	05.030.1907.209	42, 195
000 330 19 35	05.030.1907.220	42, 195
000 330 26 35	05.030.1907.140	41, 89
000 330 27 35	05.030.1907.130	41, 89
000 330 28 35	05.030.1907.210	42, 195
000 330 29 35	05.030.1907.220	42, 195
000 330 31 35	05.030.1907.150	193
000 330 32 35	05.030.1907.209	42, 195
000 330 33 35	05.030.1907.160	41, 193

Vergl.-Nr. Comp.-No.	T-Nr. T-No.	Seite page
000 330 40 35	05.030.1907.210	42, 195
000 330 41 35	05.030.1907.220	42, 195
000 330 50 35	05.030.1907.230	43, 89
000 330 58 35	05.030.1907.209	42, 195
000 330 67 35	05.030.1907.180	194
000 330 68 35	05.030.1907.190	194
000 330 69 35	05.030.1907.140	41, 89
000 330 70 35	05.030.1907.130	41, 89
000 330 71 35	05.030.1907.120	193
000 330 72 35	05.030.1907.160	41, 193
000 330 73 35	05.030.1907.209	42, 195
000 330 75 35	05.030.1980.860	93, 199
000 330 76 35	05.030.1907.410	90, 196
000 330 77 35	05.030.1907.210	42, 195
000 330 78 35	05.030.1907.220	42, 195
000 330 81 35	05.030.1907.150	193
000 330 85 35	05.030.1907.180	194
000 330 86 35	05.030.1907.190	194
000 330 87 35	05.030.1907.180	194
000 330 88 35	05.030.1907.190	194
000 330 93 35	05.030.1907.120	193
000 330 94 35	05.030.1907.160	41, 193
000 330 95 35	05.030.1907.120	193
000 330 96 35	05.030.1907.160	41, 193
000 330 97 35	05.030.1980.860	93, 199
000 330 98 35	05.030.1907.410	90, 196
000 330 99 35	05.030.1980.860	93, 199
001 330 00 35	05.030.1907.410	90, 196
001 330 01 35	05.030.1907.209	42, 195
001 330 02 35	05.030.1907.209	42, 195
001 330 03 35	05.030.1907.150	193
001 330 04 35	05.030.1907.150	193
001 330 07 35	05.030.1907.130	41, 89
001 330 08 35	05.030.1907.140	41, 89
001 330 09 35	05.030.1907.130	41, 89
001 330 10 35	05.030.1907.140	41, 89
001 330 12 35	05.030.1907.170	89, 194
001 330 14 35	05.030.1907.170	89, 194
001 330 18 35	05.030.1980.970	200
001 330 21 35	05.030.1907.210	42, 195
001 330 22 35	05.030.1907.220	42, 195
001 330 26 35	05.030.1907.210	42, 195
001 330 27 35	05.030.1907.220	42, 195
001 330 48 35	05.030.1980.900	93, 199
001 330 88 35	05.030.1907.549	43, 196
302 330 00 35	05.030.1907.549	43, 196
302 330 01 35	05.030.1907.549	43, 196
302 330 02 35	05.030.1907.549	43, 196

Vergl.-Nr. Comp.-No.	T-Nr. T-No.	Seite page
302 330 03 35	05.030.1907.549	43, 196
310 330 00 35	05.030.1910.920	44, 91
310 330 01 35	05.030.1910.930	44, 91
310 330 02 35	05.030.1910.940	44, 91
310 330 03 35	05.030.1910.950	44, 92
310 330 04 35	05.030.1907.230	43, 89
310 330 08 35	05.030.1907.230	43, 89
310 330 13 35	05.030.1907.230	43, 89
310 330 16 35	05.030.1910.930	44, 91
310 330 17 35	05.030.1910.920	44, 91
310 330 18 35	05.030.1910.940	44, 91
310 330 19 35	05.030.1910.950	44, 92
310 330 20 35	05.030.1910.920	44, 91
310 330 21 35	05.030.1910.930	44, 91
310 330 22 35	05.030.1910.940	44, 91
310 330 23 35	05.030.1910.950	44, 92
310 330 24 35	05.030.1910.920	44, 91
310 330 25 35	05.030.1910.930	44, 91
310 330 26 35	05.030.1910.940	44, 91
310 330 27 35	05.030.1910.950	44, 92
344 330 71 35	05.030.1907.120	193
344 330 72 35	05.030.1907.160	41, 193
460 330 04 35	05.030.1980.900	93, 199
460 330 12 35	05.030.1980.900	93, 199
601 330 04 35	05.030.1907.770	90
601 330 05 35	05.030.1907.780	90
601 330 06 35	05.030.1907.770	90
601 330 07 35	05.030.1907.780	90
601 330 52 35	05.030.1907.780	90
601 330 53 35	05.030.1907.770	90
602 330 01 35	05.030.1907.790	90
602 330 55 35	05.030.1907.790	90
602 330 58 35	05.030.1907.790	90
602 330 60 35	05.030.1907.790	90
631 330 04 35	05.030.1910.890	91, 197
631 330 05 35	05.030.1980.860	93, 199
000 330 01 48	05.030.1907.549	43, 196
000 330 02 48	05.030.1907.209	42, 195
901 333 04 27	05.030.1980.830	94
901 333 06 27	05.030.1980.830	94
901 333 07 27	05.030.1980.830	94
901 333 10 27	05.030.1980.830	94
901 333 11 27	05.030.1980.830	94
901 333 12 27	05.030.1980.830	94
000 338 16 10	05.030.1907.170	89, 194
000 338 24 10	05.030.1907.180	194
000 338 34 10	05.030.1907.209	42, 195
629 338 00 10	05.030.0907.130	40, 192

Vergl.-Nr. Comp.-No.	T-Nr. T-No.	Seite page
631 338 03 10	05.030.1980.840	92, 199
631 338 04 10	05.030.1980.850	92, 199
631 338 05 10	05.030.1980.900	93, 199
000 338 49 23	05.030.1910.880	197
000 338 21 29	05.030.1907.120	193
000 338 34 29	05.030.1980.860	93, 199
000 338 35 29	05.030.1980.860	93, 199
000 338 36 29	05.030.1907.120	193
000 338 49 29	05.030.1907.210	42, 195
000 338 50 29	05.030.1907.220	42, 195
008 338 00 29	05.030.1907.410	90, 196
000 340 12 07	05.030.1980.970	200
000 460 17 05	05.020.1910.280	174
000 460 43 05	05.020.1912.170	183
000 460 44 05	05.020.1911.980	183
000 460 66 05	05.020.1912.290	184
000 460 71 05	05.020.1910.620	176
000 460 72 05	05.020.1910.620	176
000 460 85 05	05.020.1910.242	174
000 460 92 05	05.020.1911.590	180
000 460 93 05	05.020.1911.590	180
000 460 95 05	05.020.1911.710	181
000 460 98 05	05.020.1911.560	179
000 460 99 05	05.020.1911.560	179
001 460 03 05	05.020.1910.650	177
001 460 04 05	05.020.1910.650	177
001 460 07 05	05.020.1911.890	182
001 460 08 05	05.020.1911.890	182
001 460 11 05	05.020.1911.660	181
001 460 13 05	05.020.1911.650	180
001 460 14 05	05.020.1911.650	180
001 460 15 05	05.020.1913.260	187
001 460 29 05	05.020.1910.630	176
001 460 30 05	05.020.1910.630	176
001 460 49 05	05.020.1913.300	188
001 460 51 05	05.020.1912.190	183
001 460 61 05	05.020.1912.180	183
001 460 67 05	05.020.1910.620	176
001 460 69 05	05.020.1911.590	180
001 460 70 05	05.020.1911.890	182
001 460 71 05	05.020.1911.710	181
001 460 73 05	05.020.1913.260	187
001 460 74 05	05.020.1913.300	188
001 460 81 05	05.020.1912.190	183
001 460 86 05	05.020.1912.220	184
001 460 87 05	05.020.1912.220	184
001 460 89 05	05.020.1912.260	184
001 460 90 05	05.020.1912.250	184

aufsteigend nach Vergleichs-Nr. | ascending to Comparison-No.

Vergl.-Nr. Comp.-No.	T-Nr. T-No.	Seite page
001 460 91 05	05.020.1912.250	184
001 460 98 05	05.020.1912.740	185
001 460 99 05	05.020.1912.740	185
002 460 04 05	05.020.1911.660	181
002 460 05 05	05.020.1911.650	180
002 460 06 05	05.020.1913.220	186
002 460 10 05	05.020.1910.242	174
002 460 12 05	05.020.1912.180	183
002 460 13 05	05.020.1912.260	184
002 460 17 05	05.020.1912.810	185
002 460 24 05	05.020.1913.330	188
002 460 25 05	05.020.1913.340	188
002 460 30 05	05.020.1913.330	188
002 460 31 05	05.020.1913.340	188
002 460 43 05	05.020.1910.640	176
002 460 44 05	05.020.1910.640	176
002 460 45 05	05.020.1911.690	181
002 460 46 05	05.020.1911.690	181
002 460 47 05	05.020.1910.660	177
002 460 48 05	05.020.1910.660	177
002 460 49 05	05.020.1911.620	180
002 460 50 05	05.020.1911.620	180
002 460 51 05	05.020.1911.550	179
002 460 52 05	05.020.1911.550	179
002 460 53 05	05.020.1913.350	188
002 460 54 05	05.020.1913.350	188
002 460 59 05	05.020.1911.440	178
002 460 60 05	05.020.1911.440	178
002 460 61 05	05.020.1912.860	186
002 460 62 05	05.020.1912.860	186
002 460 64 05	05.020.1912.740	185
002 460 75 05	05.020.1912.810	185
002 460 76 05	05.020.1912.810	185
002 460 86 05	05.020.1913.210	186
002 460 87 05	05.020.1913.210	186
002 460 88 05	05.020.1913.390	189
002 460 89 05	05.020.1913.390	189
002 460 92 05	05.020.1913.240	186
002 460 93 05	05.020.1913.240	186
002 460 96 05	05.020.1907.250	172
002 460 97 05	05.020.1907.250	172
003 460 18 05	05.020.1913.400	190
003 460 19 05	05.020.1913.400	190
003 460 29 05	05.020.1910.242	174
003 460 31 05	05.020.1911.660	181
003 460 32 05	05.020.1911.650	180
003 460 33 05	05.020.1913.260	187
003 460 40 05	05.020.1911.550	179

Vergl.-Nr. Comp.-No.	T-Nr. T-No.	Seite page
003 460 41 05	05.020.1911.440	178
003 460 42 05	05.020.1912.860	186
003 460 45 05	05.020.1913.240	186
003 460 50 05	05.020.1911.690	181
003 460 56 05	05.020.1911.620	180
003 460 58 05	05.020.1913.400	190
003 460 59 05	05.020.1911.530	179
003 460 60 05	05.020.1913.250	187
300 460 06 05	05.020.1907.760	36
300 460 07 05	05.020.1907.760	36
305 460 03 05	05.020.1907.760	36
309 460 03 05	05.020.1907.640	86
309 460 04 05	05.020.1907.640	86
309 460 05 05	05.020.1907.640	86
309 460 08 05	05.020.1907.640	86
309 460 09 05	05.020.1907.640	86
309 460 10 05	05.020.1907.640	86
309 460 11 05	05.020.1907.640	86
309 460 12 05	05.020.1907.640	86
309 460 13 05	05.020.1907.640	86
309 460 14 05	05.020.1907.640	86
309 460 20 05	05.020.1907.640	86
309 460 22 05	05.020.1907.640	86
309 460 23 05	05.020.1907.640	86
309 460 24 05	05.020.1907.640	86
309 460 25 05	05.020.1907.640	86
309 460 26 05	05.020.1907.640	86
309 460 29 05	05.020.1907.640	86
309 460 30 05	05.020.1907.640	86
309 460 31 05	05.020.1907.640	86
309 460 32 05	05.020.1907.640	86
316 460 06 05	05.020.1907.010	172
316 460 07 05	05.020.1907.010	172
316 460 08 05	05.020.1907.010	172
316 460 09 05	05.020.1907.010	172
356 460 02 05	05.020.1911.870	37
357 460 10 05	05.020.1911.570	37
357 460 11 05	05.020.1911.570	37
357 460 14 05	05.020.1911.540	36
357 460 15 05	05.020.1911.540	36
357 460 20 05	05.020.0993.600	36
357 460 22 05	05.020.1911.870	37
357 460 23 05	05.020.0993.600	36
357 460 24 05	05.020.1912.500	38
357 460 25 05	05.020.1912.490	38
357 460 31 05	05.020.1912.500	38
357 460 32 05	05.020.1912.490	38
357 460 35 05	05.010.1913.460	171

Vergl.-Nr. Comp.-No.	T-Nr. T-No.	Seite page
375 460 06 05	05.020.1911.460	179
375 460 11 05	05.020.1911.460	179
375 460 16 05	05.020.1913.260	187
383 460 06 05	05.020.1907.330	173
383 460 08 05	05.020.1907.340	173
383 460 14 05	05.020.1907.330	173
383 460 16 05	05.020.1907.340	173
383 460 23 05	05.020.1907.330	173
383 460 24 05	05.020.1907.340	173
383 460 44 05	05.020.1907.330	173
383 460 45 05	05.020.1907.340	173
385 460 08 05	05.020.1907.390	173
385 460 20 05	05.020.1907.390	173
385 460 34 05	05.020.1907.390	173
387 460 04 05	05.020.1910.280	174
387 460 06 05	05.020.1907.500	173
387 460 07 05	05.020.1907.070	172
387 460 14 05	05.020.1907.070	172
387 460 32 05	05.020.1907.070	172
387 460 33 05	05.020.1907.070	172
387 460 44 05	05.020.1907.500	173
387 460 45 05	05.020.1907.500	173
387 460 50 05	05.020.1910.280	174
406 460 03 05	05.020.1911.960	182
406 460 06 05	05.020.1911.960	182
406 460 07 05	05.020.1911.960	182
425 460 01 05	05.020.1911.760	182
425 460 02 05	05.020.1911.760	182
425 460 03 05	05.020.1911.760	182
425 460 04 05	05.020.1911.760	182
437 460 00 05	05.020.1911.760	182
437 460 01 05	05.020.1911.760	182
601 460 00 05	05.020.1907.640	86
601 460 01 05	05.020.1907.640	86
601 460 02 05	05.020.1907.640	86
601 460 03 05	05.020.1907.640	86
601 460 05 05	05.020.1910.260	87
601 460 06 05	05.020.1910.260	87
601 460 07 05	05.020.1910.260	87
601 460 08 05	05.020.1910.260	87
601 460 09 05	05.020.1910.260	87
601 460 10 05	05.020.1910.260	87
601 460 11 05	05.020.1910.260	87
601 460 12 05	05.020.1910.260	87
601 460 13 05	05.020.1910.260	87
601 460 14 05	05.020.1910.260	87
601 460 15 05	05.020.1910.260	87
617 460 00 05	05.020.1910.390	175

Vergl.-Nr. Comp.-No.	T-Nr. T-No.	Seite page
617 460 02 05	05.020.1910.390	175
617 460 20 05	05.020.1910.680	177
617 460 24 05	05.020.1910.680	177
617 460 28 05	05.020.1910.390	175
617 460 34 05	05.020.1910.680	177
619 460 11 05	05.020.1910.340	175
619 460 22 05	05.020.1910.340	175
619 460 25 05	05.020.1910.340	175
619 460 29 05	05.020.1910.340	175
619 460 48 05	05.020.1910.340	175
619 460 52 05	05.020.1910.340	175
620 460 00 05	05.020.1910.280	174
620 460 04 05	05.020.1911.670	181
620 460 08 05	05.020.1911.670	181
620 460 20 05	05.020.1910.280	174
620 460 28 05	05.020.1910.280	174
620 460 29 05	05.020.1911.670	181
620 460 30 05	05.020.1911.670	181
620 460 37 05	05.020.1910.280	174
625 460 25 05	05.020.1910.730	177
625 460 48 05	05.020.1912.170	183
625 460 50 05	05.020.1911.980	183
626 460 00 05	05.020.1911.790	37
628 460 02 05	05.020.1911.900	38
628 460 03 05	05.020.1911.880	37
628 460 11 05	05.020.1911.900	38
628 460 12 05	05.020.1911.880	37
628 460 19 05	05.020.1912.850	38
628 460 20 05	05.010.1912.840	35
631 460 07 05	05.010.1910.780	85
638 460 02 05	05.010.1910.450	84
647 460 00 05	05.020.1907.070	172
647 460 01 05	05.020.1907.070	172
667 460 07 05	05.020.1912.540	88
667 460 10 05	05.020.1912.540	88
667 460 15 05	05.020.1911.640	88
667 460 16 05	05.020.1911.910	88
667 460 17 05	05.020.1911.640	88
667 460 18 05	05.020.1911.910	88
668 460 05 05	05.020.1910.240	86
668 460 07 05	05.020.1910.240	86
668 460 09 05	05.020.1910.240	86
668 460 11 05	05.020.1910.240	86
668 460 21 05	05.020.1910.740	87
668 460 22 05	05.020.1910.740	87
670 460 08 05	05.020.1910.760	87
670 460 12 05	05.020.1910.760	87
670 460 16 05	05.020.1910.760	87

aufsteigend nach Vergleichs-Nr. | ascending to Comparison-No.

Vergl.-Nr. Comp.-No.	T-Nr. T-No.	Seite page
670 460 20 05	05.020.1910.760	87
670 460 26 05	05.020.1910.250	87
670 460 27 05	05.020.1910.250	87
670 460 28 05	05.020.1910.810	88
670 460 29 05	05.020.1910.810	88
673 460 02 05	05.020.1910.330	174
673 460 03 05	05.020.1910.820	178
673 460 04 05	05.020.1910.330	174
673 460 05 05	05.020.1910.820	178
673 460 06 05	05.020.1910.330	174
673 460 07 05	05.020.1910.820	178
673 460 08 05	05.020.1910.330	174
673 460 09 05	05.020.1910.820	178
675 460 10 05	05.020.1910.430	175
675 460 12 05	05.020.1910.610	176
675 460 16 05	05.020.1910.430	175
675 460 18 05	05.020.1910.610	176
675 460 22 05	05.020.1910.430	175
675 460 24 05	05.020.1910.610	176
675 460 28 05	05.020.1910.430	175
675 460 30 05	05.020.1910.610	176
676 460 01 05	05.020.1910.600	175
676 460 06 05	05.020.1910.600	175
676 460 11 05	05.020.1910.600	175
676 460 15 05	05.020.1910.600	175
676 460 19 05	05.020.1911.920	182
676 460 21 05	05.020.1911.920	182
676 460 31 05	05.020.1912.520	185
901 460 02 05	05.010.1910.460	84
970 460 07 05	05.020.1910.750	178
970 460 08 05	05.020.1912.640	185
970 460 09 05	05.020.1910.750	178
970 460 10 05	05.020.1912.640	185
970 460 11 05	05.020.1913.280	187
972 460 06 05	05.020.1913.360	189
972 460 14 05	05.020.1980.990	190
972 460 15 05	05.020.1910.241	174
972 460 16 05	05.020.1980.990	190
972 460 17 05	05.020.1910.241	174
972 460 18 05	05.020.1911.530	179
972 460 19 05	05.020.1913.250	187
972 460 20 05	05.020.1911.530	179
972 460 21 05	05.020.1913.250	187
972 460 28 05	05.020.1913.280	187
974 460 00 05	05.020.1913.370	189
974 460 05 05	05.020.1913.290	187
974 460 06 05	05.020.1913.370	189
974 460 09 05	05.020.1913.290	187

Vergl.-Nr. Comp.-No.	T-Nr. T-No.	Seite page
974 460 10 05	05.020.1911.580	180
974 460 11 05	05.020.1911.450	178
974 460 12 05	05.020.1911.580	180
974 460 13 05	05.020.1911.450	178
974 460 15 05	05.020.1913.380	189
976 460 04 05	05.020.1913.410	190
000 460 01 48	05.030.1907.980	196
000 460 03 48	05.030.0907.029	40, 192
000 460 06 48	05.030.0907.019	39, 191
000 460 10 48	05.030.0907.029	40, 192
000 460 12 48	05.030.0907.019	39, 191
000 460 17 48	05.030.1910.980	198
000 460 18 48	05.030.1907.980	196
000 460 21 48	05.030.1907.230	43, 89
000 460 26 48	05.030.1907.980	196
000 460 27 48	05.030.1907.980	196
000 460 28 48	05.030.0907.029	40, 192
000 460 29 48	05.030.0907.029	40, 192
000 460 34 48	05.030.0907.019	39, 191
000 460 35 48	05.030.0907.019	39, 191
000 460 41 48	05.030.1907.230	43, 89
000 460 45 48	05.030.1907.230	43, 89
000 460 49 48	05.030.0993.730	193
000 460 52 48	05.030.3040.110	200
000 460 57 48	05.030.1910.700	43, 197
000 460 58 48	05.030.1910.440	196
000 460 60 48	05.030.1910.700	43, 197
000 460 61 48	05.030.1910.440	196
000 460 68 48	05.030.1910.700	43, 197
000 460 69 48	05.030.1910.440	196
000 460 70 48	05.030.1910.700	43, 197
000 460 71 48	05.030.1910.440	196
000 460 77 48	05.030.1910.960	45
000 460 78 48	05.030.1910.970	45
000 460 85 48	05.030.1907.230	43, 89
000 460 87 48	05.030.1910.700	43, 197
000 460 89 48	05.030.0907.029	40, 192
001 460 02 48	05.030.0907.029	40, 192
001 460 03 48	05.030.0907.019	39, 191
001 460 04 48	05.030.1910.700	43, 197
001 460 05 48	05.030.1910.440	196
001 460 08 48	05.030.0907.029	40, 192
001 460 11 48	05.030.1910.700	43, 197
001 460 12 48	05.030.0907.029	40, 192
001 460 13 48	05.030.1910.440	196
001 460 14 48	05.030.0907.019	39, 191
001 460 15 48	05.030.1912.780	198
001 460 16 48	05.030.1912.780	198

Vergl.-Nr. Comp.-No.	T-Nr. T-No.	Seite page
001 460 17 48	05.030.1910.700	43, 197
001 460 18 48	05.030.0907.029	40, 192
001 460 20 48	05.030.1910.970	45
001 460 21 48	05.030.1910.960	45
001 460 22 48	05.030.0907.029	40, 192
001 460 23 48	05.030.0907.019	39, 191
001 460 25 48	05.030.1910.440	196
001 460 34 48	05.030.1907.209	42, 195
001 460 36 48	05.030.0907.019	39, 191
001 460 38 48	05.030.1912.610	198
001 460 42 48	05.030.1912.621	198
001 460 43 48	05.030.1907.549	43, 196
001 460 44 48	05.030.1907.209	42, 195
001 460 48 48	05.030.1912.610	198
001 460 50 48	05.030.1912.621	198
001 460 51 48	05.030.1912.610	198
001 460 76 48	05.030.1910.700	43, 197
001 460 77 48	05.030.0907.029	40, 192
001 460 78 48	05.030.0907.019	39, 191
001 460 79 48	05.030.1910.440	196
001 460 85 48	05.030.1912.621	198
001 460 86 48	05.030.1912.610	198
001 460 97 48	05.030.1907.209	42, 195
002 460 03 48	05.030.0907.019	39, 191
002 460 06 48	05.030.1912.780	198
002 460 10 48	05.030.1907.150	193
002 460 16 48	05.030.1907.180	194
624 460 03 48	05.030.0280.210	191
638 460 00 48	05.030.1980.870	93
699 460 16 48	05.030.0906.610	191
901 460 00 48	05.030.1980.880	93
901 460 01 48	05.030.1980.880	93
901 460 03 48	05.030.1980.880	93
906 460 00 48	05.030.1912.790	92
906 460 01 48	05.030.1912.790	92
901 460 04 55	05.010.1910.460	84
000 460 24 80	05.050.1915.080	46, 202
000 460 66 80	05.050.1915.080	46, 202
000 460 94 80	05.050.1915.090	46, 94, 202
001 460 30 80	05.050.1915.030	45, 201
001 460 31 80	05.050.1915.060	46, 202
001 460 42 80	05.050.1915.090	46, 94, 202
001 460 44 80	05.050.1915.040	45, 201
001 460 49 80	05.050.1915.090	46, 94, 202
001 460 51 80	05.050.1915.030	45, 201
001 460 52 80	05.050.1915.150	203
001 460 75 80	05.050.1915.040	45, 201
001 460 80 80	05.050.1915.090	46, 94, 202

Vergl.-Nr. Comp.-No.	T-Nr. T-No.	Seite page
001 460 85 80	05.050.1915.100	203
001 460 92 80	05.050.1915.090	46, 94, 202
002 460 07 80	05.050.1915.030	45, 201
002 460 08 80	05.050.1915.030	45, 201
002 460 15 80	05.050.1915.050	201
002 460 17 80	05.050.1915.050	201
002 460 39 80	05.050.1915.030	45, 201
002 460 41 80	05.050.1915.150	203
002 460 49 80	05.050.1915.050	201
002 460 53 80	05.050.1915.100	203
002 460 54 80	05.050.1915.040	45, 201
002 460 55 80	05.050.1915.090	46, 94, 202
002 460 58 80	05.050.1915.090	46, 94, 202
002 460 76 80	05.050.1915.080	46, 202
002 460 88 80	05.050.1915.070	202
002 460 89 80	05.050.1915.070	202
003 460 03 80	05.050.1915.170	203
003 460 19 80	05.050.1915.030	45, 201
003 460 21 80	05.050.1915.150	203
003 460 22 80	05.050.1915.070	202
003 460 49 80	05.050.1915.070	202
003 460 50 80	05.050.1915.030	45, 201
003 460 51 80	05.050.1915.060	46, 202
003 460 52 80	05.050.1915.170	203
003 460 55 80	05.050.1915.170	203
457 460 02 80	05.050.1915.050	201
000 463 10 29	05.030.1907.770	90
000 463 11 29	05.030.1907.230	43, 89
000 463 22 29	05.030.1907.209	42, 195
000 463 23 29	05.030.0280.112	190
000 463 24 29	05.030.1980.980	200
000 463 25 29	05.030.1980.980	200
000 463 26 29	05.030.0280.112	190
000 463 32 29	05.030.1907.180	194
000 463 34 29	05.030.1907.209	42, 195
000 463 46 29	05.030.0993.730	193
002 466 26 01	05.050.1915.190	95
002 466 28 01	05.050.1915.190	95
003 466 07 01	05.050.1915.190	95
003 466 71 01	05.050.1915.180	94
003 466 72 01	05.050.1915.180	94
000 466 62 03	05.050.1915.210	201
Neoplan		
11015685	05.030.1907.549	51
82192200	05.030.1907.549	51
82752400	05.030.1907.549	51
1101 9669	05.030.0280.190	49

aufsteigend nach Vergleichs-Nr. | ascending to Comparison-No.

Vergl.-Nr. Comp.-No.	T-Nr. T-No.	Seite page
120325200	05.030.0907.019	49
122353201	05.030.0907.019	49
N1011020299	05.030.0907.019	49
1203 240 01	05.030.1980.860	51
1203 240 02	05.030.1980.860	51
81.46611.6045	05.020.0993.630	48
81.46611.6085	05.020.0993.780	49
81.46711.6715	05.010.0993.610	48
81.46711.6736	05.010.0993.220	48
81.46711.6877	05.010.0994.060	48
81.95301.6286	05.030.0907.130	50
81.95301.6291	05.030.0993.870	51
81.95301.6350	05.030.0907.029	50
Renault Trucks		
0003 401 170	05.030.0907.019	211
0003 401 207	05.030.1980.970	215
0003 406 169	05.030.0907.029	212
0003 406 212	05.030.1907.209	214
0003 406 218	05.030.1907.549	214
0003 406 236	05.030.0907.029	212
0003 406 242	05.030.1907.120	213
0003 406 251	05.030.0907.029	212
0003 406 252	05.030.1907.180	97, 213
0003 406 253	05.030.1907.209	214
0003 406 254	05.030.0907.029	212
0003 406 260	05.030.0907.029	212
0003 406 261	05.030.0907.029	212
0003 486 218	05.030.1907.549	214
5000 242 159	05.030.1907.209	214
5000 288 360	05.030.0907.029	212
5000 288 361	05.030.0907.019	211
5000 295 214	05.030.1907.209	214
5000 295 215	05.030.1907.549	214
5000 295 336	05.030.1907.549	214
5000 559 335	05.030.1907.120	213
5000 590 236	05.030.0907.029	212
5000 613 598	05.010.3040.160	205
5000 804 824	05.030.0907.029	212
5000 807 553	05.030.1907.190	213
5000 807 554	05.030.1907.180	97, 213
5000 808 458	05.030.1907.980	214
5000 812 483	05.030.1907.209	214
5000 814 096	05.030.1907.190	213
5000 814 097	05.030.1907.180	97, 213
5000 823 987	05.030.1907.120	213
5001 134 533	05.030.1907.549	214
5001 823 718	05.030.0803.430	210

Vergl.-Nr. Comp.-No.	T-Nr. T-No.	Seite page
5001 830 480	05.030.1912.780	215
5001 831 481	05.030.1980.970	215
5001 832 580	05.030.1980.970	215
5001 832 581	05.030.0907.019	211
5001 834 533	05.030.1907.549	214
5001 836 298	05.030.0907.029	212
5001 844 135	05.030.1907.190	213
5001 844 136	05.030.1907.180	97, 213
5001 845 430	05.030.1912.780	215
5001 850 550	05.030.1907.549	214
5001 852 263	05.030.1907.549	214
5001 852 452	05.030.3040.110	215
5001 858 763	05.030.3040.110	215
5001 859 984	05.030.1907.549	214
5001 861 924	05.030.1907.120	213
5001 868 363	05.010.4251.501	205
5001 868 366	05.010.4256.133	206
5001 868 367	05.010.4256.131	205
5001 868 374	05.020.4256.001	210
5001 868 389	05.020.4002.242	208
5001 868 404	05.010.4256.132	206
5001 869 828	05.010.4256.320	206
5001 869 829	05.010.4256.350	207
5010 060 764	05.020.4256.000	209
5010 130 344	05.020.4251.500	208
5010 294 287	05.020.4251.530	209
5010 294 288	05.020.4251.550	209
5010 294 289	05.020.4251.540	209
5010 294 720	05.020.4256.370	210
5010 305 365	05.020.4007.085	208
5010 308 082	05.010.4256.320	206
5010 383 203	05.020.4256.190	210
5010 439 021	05.010.4256.310	206
5010 439 022	05.010.4256.360	207
5010 439 631	05.010.4256.350	207
5010 488 167	05.020.4007.084	208
5010 488 836	05.020.4256.190	210
5010 557 217	05.020.4251.540	209
5010 557 243	05.020.4256.000	209
5010 557 523	05.020.4256.190	210
5010 566 051	05.010.4007.068	205
5010 566 058	05.010.4256.330	207
5010 566 059	05.010.4256.320	206
5010 566 063	05.010.4256.310	206
5010 566 064	05.010.4256.360	207
5010 587 004	05.010.4251.501	205
5010 587 034	05.010.4256.133	206
5010 587 038	05.010.4256.133	206

Vergl.-Nr. Comp.-No.	T-Nr. T-No.	Seite page
5010 587 049	05.010.4256.132	206
5010 587 050	05.010.4256.131	205
5010 587 052	05.010.4256.132	206
5010 587 053	05.010.4256.131	205
5010 600 822	05.010.4251.501	205
5010 630 255	05.020.4007.085	208
5010 630 434	05.010.4256.340	207
5010 630 617	05.020.4251.540	209
5010 630 637	05.020.4256.001	210
5010 630 638	05.020.4256.001	210
5010 647 032	05.020.4002.242	208
5010 647 033	05.020.4002.242	208
7403 193 731	05.030.4007.042	215
7403 987 648	05.030.4007.046	216
7420 937 674	05.030.0907.130	212
7421 560 825	05.020.4256.001	210
7421 560 963	05.010.4256.133	206
7421 560 965	05.010.4256.132	206
7421 560 968	05.010.4256.131	205
7701 002 911	05.030.1907.980	214
7701 011 412	05.030.0907.029	212
7701 016 946	05.030.1907.209	214
SAF		
2.205.0003.00	05.030.0610.330	15
Scania		
111 294	05.020.3040.000	220
278 665	05.020.3001.190	220
278 666	05.020.3001.190	220
283 783	05.030.0907.019	54, 225
283 784	05.030.0907.029	55, 226
310 979	05.030.3001.220	56, 227
310 980	05.030.3001.210	55, 227
325 614	05.030.0993.730	227
390 784	05.020.3001.150	219
395 009	05.030.0907.019	54, 225
395 010	05.030.0907.029	55, 226
395 350	05.010.3040.160	53, 219
481 217	05.020.3001.720	53
481 690	05.020.3040.210	53
539 413	05.030.3001.210	55, 227
571 434	05.050.3005.110	228
571 435	05.050.3005.130	56, 229
571 436	05.050.3005.100	56, 228
571 437	05.050.3005.120	56, 229
1 308 495	05.050.3005.110	228
1 324 223	05.050.3005.130	56, 229

Vergl.-Nr. Comp.-No.	T-Nr. T-No.	Seite page
1 332 653	05.050.3005.120	56, 229
1 333 790	05.050.3005.100	56, 228
1 343 262	05.020.3040.040	221
1 343 264	05.020.3040.130	221
1 343 266	05.020.3040.060	221
1 343 278	05.020.3040.140	222
1 343 283	05.020.3040.120	221
1 356 055	05.020.3040.000	220
1 357 674	05.030.3040.110	228
1 358 675	05.010.3040.160	53, 219
1 358 792	05.030.0907.019	54, 225
1 358 793	05.030.0907.029 05.030.0907.130	55, 226 226
1 361 413	05.010.3001.620	53, 218
1 369 411	05.010.3001.120	218
1 371 404	05.050.3005.140	57, 229
1 375 228	05.030.0993.730	227
1 378 435	05.010.3040.160	53, 219
1 379 071	05.020.3040.000	220
1 379 072	05.020.3040.010	220
1 384 025	05.020.3040.000	220
1 384 027	05.020.3040.010	220
1 385 251	05.010.3001.120	218
1 385 763	05.020.3040.610	224
1 385 764	05.020.3040.550	222
1 385 765	05.020.3040.560	223
1 385 766	05.020.3040.570	223
1 386 618	05.020.3040.530	222
1 386 620	05.020.3001.132	219
1 388 958	05.010.3001.910	218
1 393 383	05.020.3001.131	219
1 394 447	05.030.3040.510	228
1 394 884	05.020.3001.650	220
1 395 614	05.010.3001.620	53, 218
1 397 866	05.010.3040.160	53, 219
1 399 757	05.020.3040.620	224
1 399 758	05.020.3040.590	223
1 409 918	05.010.3001.120	218
1 413 978	05.020.3040.650	225
1 421 272	05.050.3005.110	228
1 421 273	05.050.3005.130	56, 229
1 421 628	05.050.3005.120	56, 229
1 421 981	05.020.3040.600	224
1 422 417	05.050.3005.100	56, 228
1 423 007	05.020.3040.640	224
1 439 958	05.050.3005.100	56, 228
1 450 364	05.020.3040.350	54
1 457 708	05.050.3005.110	228

aufsteigend nach Vergleichs-Nr. | ascending to Comparison-No.

Vergl.-Nr. Comp.-No.	T-Nr. T-No.	Seite page
1 457 709	05.050.3005.130	56, 229
1 457 710	05.050.3005.100	56, 228
1 457 711	05.050.3005.120	56, 229
1 479 122	05.020.3040.220	54
1 488 890	05.030.0907.130	226
1 491 273	05.020.3040.650	225
1 501 030	05.010.3001.120	218
1 504 006	05.050.3005.140	57, 229
1 511 600	05.020.3040.580	223
1 534 756	05.030.0907.130	226
1 571 397	05.050.3005.100	56, 228
1 723 895	05.010.3001.120	218
1 723 897	05.030.0993.860	227
1 732 635	05.020.3040.130	221
1 733 471	05.020.3040.670	225
1 734 019	05.010.3001.620	53, 218
1 734 020	05.010.3040.160	53, 219
1 734 021	05.010.3001.910	218
1 737 683	05.010.3001.120	218
1 738 379	05.030.3040.110	228
1 738 380	05.030.0907.019	54, 225
1 738 381	05.030.0907.029	55, 226
1 747 467	05.020.3040.670	225
1 755 498	05.020.3040.220	54
1 755 502	05.020.3040.350	54
1 759 690	05.020.3040.060	221
1 759 691	05.020.3040.120	221
1 759 692	05.020.3040.580	223
1 765 375	05.020.3040.610	224
1 765 376	05.020.3040.550	222
1 765 377	05.020.3040.560	223
1 765 378	05.020.3040.570	223
1 765 379	05.020.3040.620	224
1 765 380	05.020.3040.590	223
1 765 382	05.020.3040.600	224
1 765 384	05.020.3040.640	224
1 767 328	05.030.0907.029	55, 226
1 768 898	05.020.3040.000	220
1 769 597	05.020.3040.010	220
1 788 520	05.020.3001.131	219
1 788 522	05.020.3040.530	222
1 847 311	05.020.3040.000	220
1 847 312	05.020.3040.010	220
1 895 858	05.020.3040.220	54
1 895 860	05.020.3040.350	54
1 897 333	05.010.3001.620	53, 218
1 897 334	05.010.3001.910	218
1 897 335	05.010.3001.120	218

Vergl.-Nr. Comp.-No.	T-Nr. T-No.	Seite page
1 897 669	05.020.3001.720	53
1 897 671	05.020.3040.210	53
1 912 757	05.020.3040.000	220
1 912 758	05.020.3040.010	220
1 912 759	05.030.0993.730	227
1 914 427	05.030.0907.029	55, 226
2 007 274	05.020.3040.140	222
2 007 278	05.020.3040.130	221
2 007 279	05.020.3040.670	225
2 028 998	05.010.3040.160	53, 219
2 051 041	05.030.0993.860	227
2 115 316	05.030.0907.130	226
2 125 091	05.010.3001.920	218
2 146 104	05.010.3001.920	218
2 154 938	05.030.0993.860	227
2 154 939	05.030.0993.860	227
Setra		
000 460 57 48	05.030.1910.700	63
000 460 60 48	05.030.1910.700	63
627 330 02 03	05.010.0994.590	59
628 330 04 03	05.010.1912.830	60
628 330 05 03	05.010.1912.820	59
628 460 19 05	05.020.1912.850	61
628 460 20 05	05.010.1912.840	60
6.851.447.000	05.030.1907.980	63
6.851.478.000	05.030.1907.980	63
6.851.485.000	05.030.0907.019	61
6.851.486.000	05.030.1907.980	63
6.851.517.000	05.030.1907.209	62
6.851.529.000	05.030.0280.280	61
6.851.533.000	05.030.1907.980	63
8.226.137.000	05.010.1911.810	59
8.226.236.058	05.030.0907.019	61
8.226.236.059	05.030.0907.029	62
8.226.308.000	05.020.1911.840	60
8.226.326.000	05.010.0994.590	59
8.226.328.000	05.010.0994.590	59
8.226.355.000	05.020.1911.790	60
8.226.381.000	05.020.1911.840	60
8.226.280.0000	05.020.1911.790	60
8.226.355.0000	05.020.1911.790	60
8.226.147.000 C	05.010.1911.810	59
8.226.280.000 B	05.020.1911.790	60
8.226.280.000 C	05.020.1911.790	60
8.226.305.000 C	05.010.1911.810	59
8.226.308.000 C	05.020.1911.840	60
8.226.313.000 C	05.010.1911.810	59

Vergl.-Nr. Comp.-No.	T-Nr. T-No.	Seite page
8.226.326.000.B	05.010.0994.590	59
8.226.328.000.C	05.010.0994.590	59
8.226.330.000.C	05.010.1911.800	59
8.226.331.000.0	05.010.1911.800	59
Solaris		
0820 352 213	05.030.1907.549	65
Van Hool		
634301260	05.030.1907.209	67
634 203 870	05.030.0280.210	67
VDL Bova		
185771	05.010.0780.017	69
185772	05.010.0780.016	69
450495	05.010.0780.016	69
450496	05.010.0780.017	69
367 352	05.050.0278.110	70
1291 227	05.050.0278.110	70
1295 415	05.010.0280.240	69
1337 644	05.010.0275.700	69
1361 157	05.010.0280.240	69
41142071	05.030.0780.003	70
41149875	05.030.3040.110	70
Volkswagen		
2D0 422 803	05.010.1910.460	99
2D0 422 811	05.030.1980.880	99
2E0 498 104	05.030.1912.790	99
2E0 713 501	05.030.1912.790	99
2D0 407 361 A	05.030.1980.830	99
2E0 498 104 A	05.030.1912.790	99
Volvo		
111 302	05.020.4002.240	236
0366 757	05.030.4002.439	77, 254
0366 758	05.030.4002.449	77, 254
0382 745	05.030.4002.411	77, 253
1071 169	05.020.4004.900	242
1071 170	05.020.4004.720	240
1071 316	05.020.4007.032	245
1071 344	05.020.4002.570	239
1075 005	05.020.4002.280	237
1075 006	05.020.4004.910	242
1075 153	05.020.4002.290	238
1075 663	05.020.4002.240	236
1075 664	05.020.4004.760	241
1080 786	05.020.4004.880	242

Vergl.-Nr. Comp.-No.	T-Nr. T-No.	Seite page
1088 985	05.020.4004.920	242
1088 987	05.020.4007.074	246
1088 988	05.020.4007.077	247
1131 741	05.030.4002.470	78, 255
1131 742	05.030.4002.460	78, 255
1131 744	05.030.4002.450	77, 254
1190 778	05.030.1907.180	76, 252
1194 824	05.020.4004.980	74, 243
1197 338	05.020.4002.400	73
1197 339	05.020.4002.550	73
1505 758	05.030.4002.439	77, 254
1505 759	05.030.4002.449	77, 254
1507 822	05.030.4002.439	77, 254
1507 823	05.030.4002.449	77, 254
1507 826	05.030.4002.480	78, 255
1517 279	05.030.1907.160	251
1517 439	05.030.1907.160	251
1517 440	05.030.1907.120	251
1517 444	05.030.1907.120	251
1517 448	05.030.1907.190	252
1517 449	05.030.1907.180	76, 252
1518 142	05.030.1907.180	76, 252
1524 382	05.010.4007.067	234
1527 234	05.030.4002.411	77, 253
1576 092	05.020.4002.270	237
1585 013	05.050.4014.040	80, 259
1589 925	05.050.4014.030	80, 258
1592 939	05.020.4004.710	240
1592 940	05.020.4002.330	238
1599 175	05.010.4007.014	232
1606 283	05.020.4002.270	237
1606 980	05.030.0993.730	251
1610 338	05.020.4002.250	237
1612 254	05.010.4007.011	231
1613 351	05.010.4007.014	232
1626 494	05.010.4007.013	232
1626 670	05.020.4004.950	243
1626 671	05.010.4007.014	232
1626 672	05.020.4004.980	74, 243
1626 751	05.020.4002.250	237
1628 207	05.010.4007.065	72, 234
1628 635	05.020.4004.770	241
1628 636	05.020.4002.370	239
1628 637	05.010.4002.390	231
1629 397	05.020.4002.580	239
1668 638	05.030.4002.411	77, 253
1695 511	05.030.1907.160	251
1695 585	05.030.4002.480	78, 255

aufsteigend nach Vergleichs-Nr. | ascending to Comparison-No.

Vergl.-Nr. Comp.-No.	T-Nr. T-No.	Seite page
1695 689	05.030.1907.549	253
1695 690	05.030.1907.209	252
1695 776	05.030.4002.480	78, 255
1696 057	05.030.1907.209	252
1696 900	05.030.4002.470	78, 255
1696 901	05.030.4002.460	78, 255
1696 919	05.030.1980.860	253
1696 920	05.030.1907.410	253
1697 246	05.030.4007.017	256
1697 247	05.030.1907.209	252
1698 047	05.030.4007.017	256
1698 190	05.030.1907.160	251
1698 191	05.030.1907.120	251
1698 532	05.030.4002.449	77, 254
1698 533	05.030.4002.439	77, 254
1698 557	05.030.4002.480	78, 255
1698 558	05.030.4002.450	77, 254
1698 839	05.030.1907.549	253
1698 840	05.030.4002.450	77, 254
1698 846	05.030.4002.449	77, 254
1698 847	05.030.4002.439	77, 254
1699 400	05.030.4002.470	78, 255
1699 401	05.030.4002.460	78, 255
3090 291	05.030.0907.200	251
3090 727	05.030.4002.449	77, 254
3090 728	05.030.4002.439	77, 254
3092 471	05.030.4002.439	77, 254
3092 472	05.030.4002.449	77, 254
3093 647	05.030.4007.038	78, 256
3097 228	05.030.4004.840	255
3097 999	05.030.4007.041	256
3098 294	05.020.4004.930	74
3098 332	05.030.4007.017	256
3099 128	05.030.0907.200	251
3099 230	05.010.1912.380	231
3099 529	05.030.4004.840	255
3112 050	05.010.4002.620	72
3112 122	05.020.4002.640	73
3112 273	05.020.4007.023	75
3116 050	05.020.4004.700	73
3124 480	05.020.4002.600	239
3172 197	05.050.4014.050	259
3193 731	05.030.4007.042	79, 257
3198 234	05.010.4007.062	233
3198 276	05.010.4007.012	231
3199 225	05.020.4004.820	241
3962 343	05.010.4002.390	231
3985 570	05.010.4007.011	231

Vergl.-Nr. Comp.-No.	T-Nr. T-No.	Seite page
3985 571	05.010.4007.011	231
3986 328	05.050.4014.010	258
3986 450	05.010.4002.390	231
3986 452	05.020.4004.830	241
3987 648	05.030.4007.046	79, 257
3988 695	05.020.4002.290	238
3988 697	05.020.4002.290	238
3988 698	05.020.4002.360	238
3988 700	05.020.4002.360	238
3988 701	05.020.4004.760	241
3988 704	05.020.4002.240	236
3988 708	05.020.4004.770	241
3988 710	05.020.4004.770	241
3988 711	05.010.4002.390	231
3988 764	05.020.4007.071	245
3988 766	05.020.4007.071	245
3988 767	05.020.4007.070	245
3988 965	05.030.4002.449	77, 254
3988 968	05.030.4002.439	77, 254
4510 697	05.010.4007.011	231
5001 933	05.050.4014.030	80, 258
5001 934	05.050.4014.040	80, 259
6777 855	05.020.4002.600	239
6790 572	05.020.4002.300	238
6791 948	05.020.4002.600	239
6799 189	05.020.4004.940	243
6799 190	05.020.4002.680	240
6869 744	05.030.4002.450	77, 254
6882 112	05.030.4002.450	77, 254
6884 001	05.030.4002.439	77, 254
6889 483	05.030.4002.470	78, 255
6889 484	05.030.4002.460	78, 255
8112 963	05.050.4014.050	259
8113 269	05.050.4014.050	259
8133 047	05.050.4014.040	80, 259
8147 293	05.020.4007.007	244
8151 876	05.030.4007.030	256
8156 123	05.010.4007.028	72, 232
8156 657	05.020.4002.360	238
8159 831	05.050.4014.050	259
8190 146	05.020.4007.007	244
8190 147	05.020.4007.009	244
9519 278	05.020.4004.730	74
9519 279	05.020.4007.018	74
9522 701	05.020.4002.241	72
9959 151	05.010.4002.620	72
9959 152	05.020.4007.023	75
9959 153	05.020.4002.640	73

Vergl.-Nr. Comp.-No.	T-Nr. T-No.	Seite page
20 321 617	05.030.4002.412	79
20 361 568	05.010.4007.031	232
20 367 555	05.020.4002.243	237
20 374 698	05.030.4007.044	257
20 374 831	05.020.4004.990	243
20 375 555	05.020.4004.830	241
20 375 787	05.020.4007.072	246
20 383 080	05.010.4007.066	234
20 390 745	05.020.4007.033	245
20 390 746	05.020.4007.079	247
20 393 059	05.020.4002.360	238
20 393 061	05.020.4002.290	238
20 393 063	05.020.4004.760	241
20 393 065	05.020.4007.071	245
20 393 067	05.020.4007.070	245
20 393 069	05.020.4002.240	236
20 393 071	05.020.4007.007	244
20 393 073	05.020.4007.009	244
20 393 075	05.020.4002.580	239
20 393 077	05.020.4007.077	247
20 393 079	05.020.4004.770	241
20 393 083	05.020.4004.920	242
20 393 089	05.020.4004.740	240
20 393 093	05.020.4004.820	241
20 393 097	05.010.4007.011	231
20 393 186	05.020.4004.830	241
20 393 187	05.020.4007.027	244
20 399 543	05.010.4007.064	233
20 400 909	05.020.4002.600	239
20 400 944	05.020.4002.570	239
20 428 433	05.020.4007.077	247
20 442 109	05.020.4007.078	247
20 442 111	05.020.4004.740	240
20 442 115	05.020.4004.820	241
20 453 063	05.020.4007.073	246
20 453 064	05.020.4007.076	247
20 453 450	05.050.4014.000	79, 258
20 453 453	05.050.4014.020	80, 258
20 482 481	05.050.4014.020	80, 258
20 490 120	05.020.4007.018	74
20 490 123	05.020.4004.730	74
20 497 798	05.010.4002.620	72
20 497 799	05.020.4007.023	75
20 497 800	05.020.4002.640	73
20 513 947	05.020.4007.078	247
20 513 949	05.020.4004.740	240
20 513 953	05.020.4004.820	241
20 581 086	05.010.4007.063	233

Vergl.-Nr. Comp.-No.	T-Nr. T-No.	Seite page
20 581 089	05.030.4007.043	257
20 581 632	05.020.4007.075	246
20 582 398	05.010.4256.330	236
20 582 399	05.010.4007.068	234
20 584 291	05.020.4007.076	247
20 587 731	05.010.4007.061	233
20 709 844	05.020.4007.084	248
20 710 008	05.030.4002.420	254
20 739 867	05.030.4002.412	79
20 742 117	05.010.4007.067	234
20 742 127	05.030.0907.029	76, 250
20 742 129	05.030.0907.019	75, 249
20 745 923	05.020.4004.730	74
20 745 924	05.020.4007.018	74
20 777 411	05.020.4002.242	236
20 818 840	05.020.4007.085	248
20 830 369	05.010.1912.380	231
20 937 674	05.030.0907.130	250
20 994 563	05.030.4002.412	79
21 106 933	05.020.4007.072	246
21 106 936	05.020.4007.033	245
21 106 938	05.010.4007.061	233
21 106 952	05.020.4007.027	244
21 106 968	05.020.4007.079	247
21 188 993	05.050.4014.020	80, 258
21 188 995	05.050.4014.070	259
21 252 480	05.020.4004.990	243
21 252 481	05.010.4007.066	234
21 260 275	05.010.4007.062	233
21 260 286	05.010.4007.011	231
21 263 974	05.030.4004.840	255
21 299 034	05.010.4007.064	233
21 308 024	05.020.4007.018	74
21 406 952	05.020.4007.027	244
21 560 965	05.010.4256.132	235
21 560 968	05.010.4256.131	235
22 159 753	05.010.4007.061	233
22 159 757	05.020.4007.083	248
22 159 758	05.010.4007.066	234
22 159 760	05.010.4007.062	233
22 159 761	05.020.4007.081	248
22 159 769	05.010.4007.064	233
22 163 637	05.010.4256.133	235
22 163 638	05.010.4256.340	236
22 482 972	05.010.4007.068	234
22 482 975	05.010.4256.330	236
24 424 074	05.050.4014.020	80, 258
24 424 075	05.050.4014.060	259

aufsteigend nach Vergleichs-Nr. | ascending to Comparison-No.

Vergl.-Nr. Comp.-No.	T-Nr. T-No.	Seite page
24 424 123	05.050.4014.070	259
24 424 124	05.050.4014.070	259
24 425 654	05.020.4007.078	247
24 425 658	05.020.4004.740	240
24 425 660	05.020.4007.010	244
24 425 662	05.020.4004.820	241
25 370 844	05.010.4256.132	235
25 370 845	05.010.4256.131	235
25 372 885	05.010.4251.501	235
70 314 325	05.030.4002.412	79
85 000 031	05.050.4014.010	258
85 000 256	05.050.4014.070	259
85 000 768	05.050.4014.020	80, 258
85 000 769	05.050.4014.060	259
85 000 770	05.050.4014.070	259
85 000 972	05.050.4014.020	80, 258
85 000 973	05.050.4014.060	259
85 000 974	05.050.4014.070	259
85 103 704	05.050.4014.020	80, 258
85 103 705	05.050.4014.060	259
85 104 188	05.030.4007.041	256
85 104 265	05.020.4004.930	74
85 114 146	05.030.4002.480	78, 255
85 114 147	05.030.4002.450	77, 254
85 114 187	05.020.4007.032	245
85 114 200	05.020.4002.370	239
85 114 240	05.010.4002.620	72
85 114 316	05.050.4014.020	80, 258
85 114 317	05.050.4014.060	259
85 114 318	05.050.4014.070	259
85 115 631	05.010.4007.064	233
85 115 641	05.010.4007.031	232

ZF

7672.955.287	05.050.0278.110	70, 121
7673.955.202	05.050.4014.030	80, 258
7673.955.211	05.050.4014.040	80, 259
7673.955.294	05.050.0884.010	136
7684.955.182	05.050.1915.090	46, 94, 202
7684.955.198	05.050.1915.080	46, 202
7684.955.763	05.050.4014.020	80, 258
7684.974.704	05.050.4014.010	258
7685 955 180	05.050.0916.100	161
7685.955.246	05.050.1915.040	45, 201
7685.955.247	05.050.1915.100	203
7685.955.253	05.050.1915.050	201
7685 955 324	05.050.0916.100	161
7685.955.325	05.050.0916.110	32, 161

Vergl.-Nr. Comp.-No.	T-Nr. T-No.	Seite page
7685.955.359	05.050.0916.120	162
7685 955 791	05.050.4014.060	259
7686 955 729	05.050.4014.070	259
7692 900 504	05.050.1915.190	95
7692 900 530	05.050.1915.180	94
8694.974.519	05.050.4014.000	79, 258
8695.671.117	05.050.0278.130	122
8695.955.116	05.050.0884.000	19, 22, 135
8695.955.147	05.050.1915.030	45, 201
8695.955.149	05.050.1915.070	202
8696.955.112	05.050.1915.150	203
8696 974 502	05.050.4014.070	259







Zuhause in Coppenbrügge. At home in Coppenbrügge.

Für Ihren Besuch bei uns stellen wir Ihnen hier eine Anfahrtsbeschreibung bereit.

Bei Fragen zu Ihrem Weg zu uns, stehen wir Ihnen gern zur Verfügung.

Nächste Bahnstation: Bahnhof Coppenbrügge

Nächster Flughafen: Flughafen Hannover-Langenhagen

For your visit at our premises, here we provide you with a journey description.

If you have any questions regarding your way to us, please do not hesitate to contact us.

Next railway station: Station Coppenbrügge

Next airport: Airport Hannover-Langenhagen

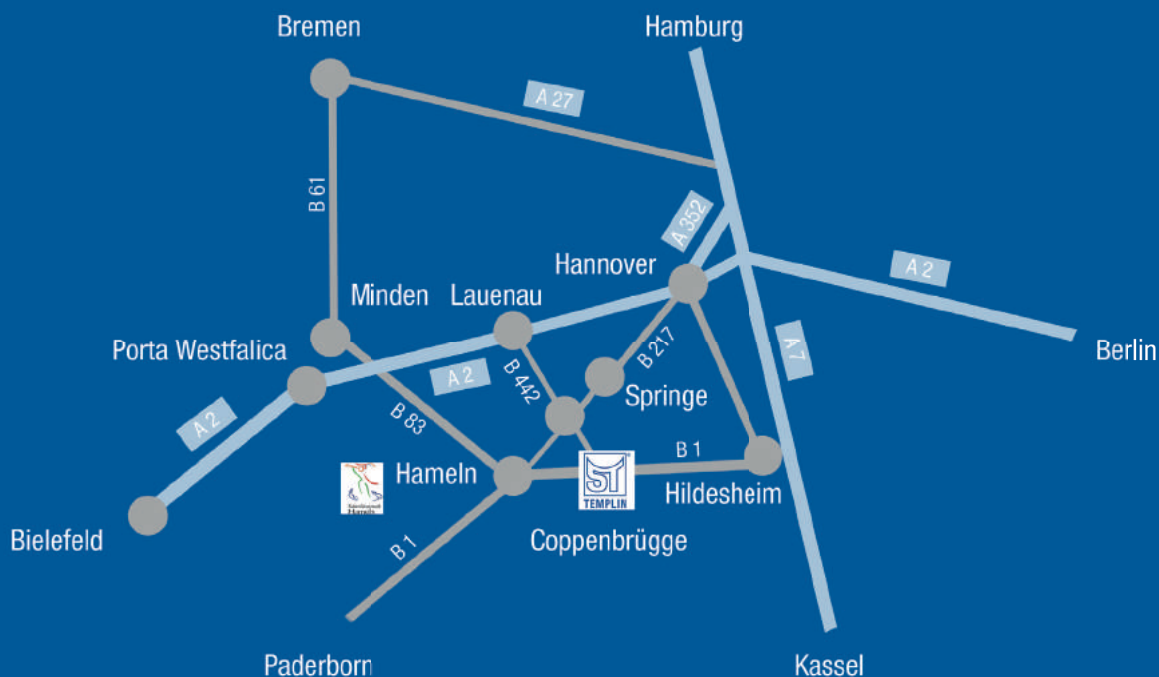

Lenkung Steering

Adresse Address

ST-Templin Automotive GmbH
Domänenweg 1
D-31863 Coppenbrügge
Germany
www.st-templin.com

Fon: +49 5156 9610-0
Fax: +49 5156 9611-96
E-Mail: info@st-templin.com
20.040.0003.070